

# **FURUNO**

## **OPERATOR'S MANUAL**

*FACSIMILE RECEIVER*

Model

**FAX-30**

---

**FURUNO ELECTRIC CO., LTD.**

9-52 Ashihara-cho,  
Nishinomiya, 662-8580, JAPAN

• FURUNO Authorized Distributor/Dealer

All rights reserved. Printed in Japan

Pub. No. OME-62600-L1

(SEHA ) FAX-30

A : SEP. 2002  
L1 : OCT. 16, 2025



0 0 0 8 0 9 3 7 5 1 7

# IMPORTANT NOTICES

---

## General

- This manual has been authored with simplified grammar, to meet the needs of international users.
- The operator of this equipment must read and follow the instructions in this manual. Wrong operation or maintenance can void the warranty or cause injury.
- Do not copy any part of this manual without written permission from FURUNO.
- If this manual is lost or worn, contact your dealer about replacement.
- The contents of this manual and the equipment specifications can change without notice.
- The example screens (or illustrations) shown in this manual can be different from the screens you see on your display. The screens you see depend on your system configuration and equipment settings.
- Save this manual for future reference.
- Any modification of the equipment (including software) by persons not authorized by FURUNO will void the warranty.
- The following concern acts as our importer in Europe, as defined in DECISION No 768/2008/EC.
  - Name: FURUNO EUROPE B.V.
  - Address: Siriusstraat 86, 5015 BT, Tilburg, The Netherlands
- The following concern acts as our importer in UK, as defined in SI 2016/1025 as amended SI 2019/470.
  - Name: FURUNO (UK) LTD.
  - Address: West Building Penner Road Havant Hampshire PO9 1QY, U.K.
- All brand, product names, trademarks, registered trademarks, and service marks belong to their respective holders.
- Internet Explorer, Microsoft, Microsoft Edge, Windows, Windows Vista, and Windows XP are trademarks of the Microsoft group of companies.

## How to discard this product

Discard this product according to local regulations for the disposal of industrial waste. For disposal in the USA, see the homepage of the Electronics Industries Alliance (<http://www.eiae.org/>) for the correct method of disposal.

## How to discard a used battery

Some FURUNO products have a battery(ies). To see if your product has a battery, see the chapter on Maintenance. If a battery is used, tape the + and - terminals of the battery before disposal to prevent fire, heat generation caused by short circuit.

### In the European Union

The crossed-out trash can symbol indicates that all types of batteries must not be discarded in standard trash, or at a trash site. Take the used batteries to a battery collection site according to your national legislation and the Batteries Directive 2006/66/EU.



### In the USA

The Mobius loop symbol (three chasing arrows) indicates that Ni-Cd and lead-acid rechargeable batteries must be recycled. Take the used batteries to a battery collection site according to local laws.



### In the other countries

There are no international standards for the battery recycle symbol. The number of symbols can increase when the other countries make their own recycling symbols in the future.



# SAFETY INSTRUCTIONS

## Safety Instructions for the Operator



### WARNING



**ELECTRICAL SHOCK HAZARD**  
Do not open the equipment.

Only qualified personnel should work inside the equipment.

**Immediately turn off the power at the switchboard if water leaks into the equipment or something is dropped in the equipment.**

Continued use of the equipment can cause fire or electrical shock. Contact a FURUNO agent for service.

**Do not disassemble or modify the equipment.**

Fire, electrical shock or serious injury can result.

**Do not place liquid-filled containers on the top of the equipment.**

Fire or electrical shock can result if a liquid spills into the equipment.

**Immediately turn off the power at the switchboard if the equipment is emitting smoke or fire.**

Continued use of the equipment can cause fire or electrical shock. Contact a FURUNO agent for service.

**Make sure no rain or water splash leaks into the equipment.**

Fire or electrical shock can result if water leaks in the equipment.



### CAUTION

**Use the proper fuse.**

Use of a wrong fuse may cause serious damage to the equipment and void the warranty.

### WARNING LABEL

**A warning label is attached to the facsimile receiver. Do not remove the label. If the label is missing or illegible, contact a FURUNO agent or dealer about replacement.**

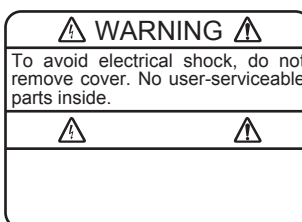

Name: Warning Label (1)  
Type: 86-003-1011-1  
Code No.: 100-236-231

## Safety Instructions for the Installer



### **WARNING**



**ELECTRICAL SHOCK HAZARD**  
Do not open the equipment unless totally familiar with electrical circuits and service manual.

Only qualified personnel should work inside the equipment.

**Turn off the power at the switchboard before beginning the installation.**

Fire or electrical shock can result if the power is left on.

**Do not install the equipment where it may get wet from rain or water splash.**

Water in the equipment can result in fire, electrical shock or damage the equipment.

**Be sure that the power supply is compatible with the voltage rating of the equipment.**

Connection of an incorrect power supply can cause fire or damage the equipment.



### **CAUTION**

Observe the following compass safe distances to prevent interference to a magnetic compass:

	Standard compass	Steering compass
Facsimile Receiver	0.9 m	0.6 m

# TABLE OF CONTENTS

---

<b>FOREWORD .....</b>	<b>vii</b>
<b>SYSTEM CONFIGURATION .....</b>	<b>x</b>
<b>EQUIPMENT LISTS .....</b>	<b>xii</b>
<b>1. OVERVIEW, SETUP .....</b>	<b>1-1</b>
1.1 Setup: NavNet and NavNet vx2 .....	1-1
1.1.1 Controls .....	1-1
1.1.2 Preparations for using the FAX-30 .....	1-2
1.1.3 Accessing the FAX mode .....	1-3
1.1.4 Choosing the receive mode .....	1-4
1.1.5 Receive notification .....	1-5
1.2 Setup: PC .....	1-6
1.2.1 Accessing the FAX-30 top display .....	1-6
1.2.2 Choosing the receive mode .....	1-8
1.2.3 Logging out .....	1-8
1.3 Setup: NavNet 3D .....	1-9
1.3.1 Controls .....	1-9
1.3.2 How to use FAX-30 with NavNet 3D .....	1-10
1.3.3 Receive mode .....	1-12
1.3.4 Logout .....	1-12
<b>2. FAX OPERATION: NavNet and NavNet vx2 .....</b>	<b>2-1</b>
2.1 Automatic Receiving .....	2-1
2.1.1 Choosing channel .....	2-1
2.1.2 Previewing image being received .....	2-4
2.1.3 Stopping automatic receiving .....	2-4
2.2 Manually Starting, Stopping Receiving .....	2-5
2.2.1 Manually starting receiving .....	2-5
2.2.2 Manually stopping receiving .....	2-6
2.3 Timer Receiving .....	2-7
2.3.1 Setting timer receiving schedule .....	2-7
2.3.2 Turning on/off specific timer programs .....	2-11
2.3.3 Clearing all timer programs .....	2-11
2.4 Displaying Facsimile Images .....	2-12
2.5 Processing Facsimile Images .....	2-13
2.5.1 Phase mismatch .....	2-13
2.5.2 Phasing signal out of synchronization .....	2-14
2.5.3 Noise rejection .....	2-14
2.5.4 Image color .....	2-15
2.5.5 Image format .....	2-15
2.5.6 Zooming images .....	2-16
2.5.7 Rotating images .....	2-16
2.6 Erasing Facsimile Images .....	2-16
2.7 Preventing Erasure of Facsimile Images .....	2-17
2.8 Adding Facsimile Channels .....	2-18

<b>3. FAX OPERATION: NavNet 3D, PC .....</b>	<b>3-1</b>
3.1 Automatic Receiving .....	3-1
3.1.1 Starting receiving .....	3-1
3.1.2 Stopping receiving .....	3-1
3.2 Timer Receiving .....	3-2
3.2.1 Setting, changing timer receiving schedule .....	3-2
3.2.2 Turning on/off specific timer programs .....	3-4
3.2.3 Clearing all timer programs .....	3-4
3.3 Displaying Facsimile Images .....	3-5
3.4 Processing Facsimile Images .....	3-6
3.4.1 Phase mismatch .....	3-6
3.4.2 Phasing signal out of synchronization .....	3-7
3.4.3 Noise rejection .....	3-7
3.4.4 Image color .....	3-8
3.4.5 Image format .....	3-8
3.4.6 Rotating images .....	3-9
3.4.7 Zooming images .....	3-9
3.4.8 Saving images .....	3-9
3.5 Erasing Facsimile Images .....	3-9
3.6 Preventing Erasure of Facsimile Images .....	3-10
3.7 Adding Facsimile Channels .....	3-11
<b>4. NAVTEX OPERATION: NavNet and NavNet vx2 .....</b>	<b>4-1</b>
4.1 About Navtex Messages .....	4-1
4.1.1 Message categories .....	4-1
4.1.2 Receiving navtex messages .....	4-1
4.2 Setting Up Navtex Stations, Messages, Alarms .....	4-2
4.3 Previewing Incoming Navtex Messages .....	4-5
4.4 Displaying Navtex Messages .....	4-6
4.4.1 Displaying navtex messages .....	4-6
4.4.2 Remarks on navtex messages .....	4-7
4.5 Displaying the Navtex Station List .....	4-8
4.6 Adding Navtex Stations .....	4-9
<b>5. NAVTEX OPERATION: NavNet 3D, PC .....</b>	<b>5-1</b>
5.1 About Navtex Messages .....	5-1
5.1.1 Message categories .....	5-1
5.1.2 Receiving navtex messages .....	5-1
5.2 Setting Up Navtex Stations, Messages .....	5-2
5.3 Displaying Navtex Messages .....	5-3
5.4 Displaying the Navtex Station List .....	5-4
5.5 Adding Navtex Stations .....	5-5
5.6 Editing Navtex Stations .....	5-6
5.7 Deleting Navtex Stations .....	5-7
<b>6. MAINTENANCE, TROUBLESHOOTING .....</b>	<b>6-1</b>
6.1 Maintenance .....	6-1
6.2 Replacement of Fuse .....	6-2
6.3 Troubleshooting .....	6-2

6.4	Diagnostics .....	6-3
6.4.1	NavNet.....	6-3
6.4.2	NavNet 3D, PC .....	6-4
6.5	Clearing Data .....	6-5
6.5.1	NavNet.....	6-5
6.5.2	NavNet 3D, PC .....	6-6
6.6	All Clear (for technicians).....	6-7
6.7	Simulation Mode .....	6-8
6.7.1	NavNet.....	6-8
6.7.2	Navnet 3D, PC.....	6-9
<b>7.</b>	<b>INSTALLATION.....</b>	<b>7-1</b>
7.1	Facsimile Receiver .....	7-1
7.2	Antenna Unit.....	7-2
7.2.1	General antenna connection.....	7-2
7.2.2	Wire antenna or whip antenna.....	7-2
7.2.3	Installation of preamp unit FAX-5 (option).....	7-3
7.3	Wiring .....	7-4
7.4	Supplying Power to the Preamp Unit.....	7-6
7.5	Browser, PC Settings.....	7-7
7.5.1	Browser settings .....	7-7
7.5.2	PC settings .....	7-8
<b>APPENDIX</b>	<b>.....</b>	<b>AP-1</b>
	Facsimile Stations .....	AP-1
	Navtex Stations .....	AP-4
	Menu Tree .....	AP-12
<b>SPECIFICATIONS</b>	<b>.....</b>	<b>SP-1</b>
<b>PACKING LIST</b>	<b>.....</b>	<b>A-1</b>
<b>OUTLINE DRAWINGS</b>	<b>.....</b>	<b>D-1</b>
<b>INTERCONNECTION DIAGRAM</b>	<b>.....</b>	<b>S-1</b>
<b>INDEX</b>	<b>.....</b>	<b>IN-1</b>

# FOREWORD

---

## A Word to the Owner of the FAX-30

FURUNO Electric Company thanks you for purchasing the FURUNO FAX-30 Facsimile Receiver. We are confident you will discover why the FURUNO name has become synonymous with quality and reliability.

Since 1948, FURUNO Electric Company has enjoyed an enviable reputation for quality and reliability throughout the world. This dedication to excellence is furthered by our extensive global network of agents and dealers.

Your equipment is designed and constructed to meet the rigorous demands of the marine environment. However, no machine can perform its intended function unless properly installed and maintained. Please carefully read and follow the operation, installation and maintenance procedures set forth in this manual.

We would appreciate feedback from you, the end-user, about whether we are achieving our purposes.

Thank you for considering and purchasing FURUNO.

## Features

Connected to a NavNet series display unit (MODEL 1833C/1943C, MFDBB, MFD8/MFD12) or a PC, the FAX-30 receives facsimile images and navtex messages, transmitted from facsimile and navtex stations.

- Programmed with all existing facsimile stations and frequencies. User may program 320 channels.
- Fully automatic facsimile operation with built-in schedule timer. Storage for 30 timer programs.
- Fully automatic selection of speed, IOC, phase alignment and frequency. Manual selection also available.
- Connection to printer via a PC to print facsimile images and navtex messages.
- Facsimile images in monochrome, gray scale (8 tones) or color (three patterns).
- Built in navtex receiver. (The receiver does not conform to GMDSS regulations.)

## Program No.

- 0850189-08.\*\* (\*\* denotes minor modifications.)

## CE/UKCA declaration

With regards to CE/UKCA declarations, please refer to our website ([www.furuno.com](http://www.furuno.com)), for further information about RoHS conformity declarations.

## Disclosure of Information about China RoHS

With regards to China RoHS information for our products, please refer to our website ([www.furuno.com](http://www.furuno.com)).

# Operational Characteristics

## General

- The equipment receives one facsimile image or naxtex message at a time. Thus, a navtex message cannot be received when a facsimile image is being received and vice versa, regardless of navtex message category.
- Three receiving modes are available, facsimile, navtex, and facsimile(timer) & navtex. When using the facsimile(timer) and navtex, the order of priority is  
Facsimile(timer) (highest priority) → Navtex (lowest priority)
- The FAX-30 does not have an internal clock, so time is input from a NavNet display or the PC. (For a PC-only configuration, time data is read when the browser accesses the FAX-30. Therefore, turn on the FAX-30 before accessing it from the PC to allow for input of time data, which is necessary for facsimile timer recording.) To receive time data, do the following:  
NavNet: Output the date and time data sentence ZDA through the NavNet network.  
PC: Set the PC's clock to the correct time.
- If both a NavNet series unit and a PC are used, it is recommended to operate the FAX-30 from the PC because of the two different communication protocols. (Use the NavNet series unit to feed navigation data to the PC.)
- Navigation data must be fed through the network to use the automatic navtex mode. Therefore, this mode is not available in the PC-only configuration.

## NavNet

- The FAX-30 cannot be accessed from the NavNet for 15 seconds after the FAX-30 has been turned on.
- NavNet requirements:  
Navionics: Ver. 15, Boot Ver. 2 (1950006002)  
C-MAP by Jeppesen: Ver. 11, Boot Ver. 2 (1950006002)

## NavNet 3D

The FAX-30 cannot be accessed when it is starting up, because image data is being loaded. You can access the FAX-30 when the LED flashes 0.4 seconds every 2 seconds, which starts approximately two minutes after the power is turned on.

## PC

- The FAX-30 cannot be accessed from the PC while the FAX-30 is loading data at start up. Wait until the POWER LED flashing interval changes from 0.4 to two seconds before accessing the FAX-30.
- Most operating procedures in this manual are written for use with the Internet Explorer®. Menu items, control button names, etc. may be different on the Netscape Navigator.

- PC requirements:  
OS: Windows® 98, Windows® 2000, Windows XP®, Windows Vista®, Windows® 7(32bit/64bit), Windows® 8(32bit/64bit), Windows® 10 (64bit), Windows® 11(64bit)
- Browser requirements:  
Internet Explorer®: Ver.5.01/5.5/6.0/7.0/8.0/10.0/11.0  
Netscape Navigator: Ver.4.78/6.2/7.0
- OS and browser compatibility

	Internet Explorer®							Netscape Navigator			Micro soft Edge ®
	Ver. 5.01 SP2	Ver. 5.5 SP2	Ver 6.0 SP1	Ver 7.0 SP0	Ver 8.0 SP0	Ver 10.0	Ver 11.0	Ver. 4.78	Ver. 6.2	Ver. 7.0	
Windows® 98	OK	OK	#	#	#	#	#	*1, *2	*2	NO, *3	#
Windows® 2000	OK	OK	OK	#	#	#	#	*1	#	OK	#
Windows XP®	#	#	OK	#	#	#	#	#	#	OK	#
Windows Vista®	#	#	#	OK	#	#	#	#	#	#	#
Windows® 7	#	#	#	#	OK	#	#	#	#	#	#
Windows® 8	#	#	#	#	#	OK	#	#	#	#	#
Windows® 10	#	#	#	#	#	#	OK	#	#	#	#
Windows® 11	#	#	#	#	#	#	#	#	#	#	OK

\*1 A facsimile image may not be updated after it has been processed (noise limiter, zoom, etc.). To update the image, click the right button on the mouse while holding down the [SHIFT] key and then choose Reload.

\*2 Connection is occasionally interrupted. In case of 4.78 + Win 98, the message "A network error occurred: unable to connect to server (TCP Error: Not enough memory). The server may be down or unreachable. Try connecting again later." is displayed. To restore the connection, press [Ctrl]+[Alt]+[Delete] to force quit Netscape. Then, reopen Netscape and try to connect again.

\*3 Connection is frequently interrupted and cannot be restored.

# Not verified.

- Use of older OS with recent browser will result in extremely slow operation.
- If the browser goes into timeout while an image is being received, access to the FAX-30 may be interrupted. In this case, click the right button on the mouse and click Refresh.
- Most PC operations are done with the left button on the mouse. The exception is saving a facsimile image that is done with the right button.
- The FAX-30 cannot be simultaneously accessed by multiple PCs. For this reason, be sure to use the logout feature to logout a PC from the FAX-30 when its use is not required.
- If the FAX-30 appears to be abnormal, the browser version may not be compatible or browser settings may be wrong. See the browser requirements on the previous page, the browser and OS compatibility table above and the browser settings in paragraph 7.5.1.
- The HTTP and HTML versions of the FAX-30 are as shown below.  
HTTP: Ver. 1.0  
HTML: Ver. 4.01

# SYSTEM CONFIGURATION

## Installation with NavNet, NavNet vx2, NavNet 3D

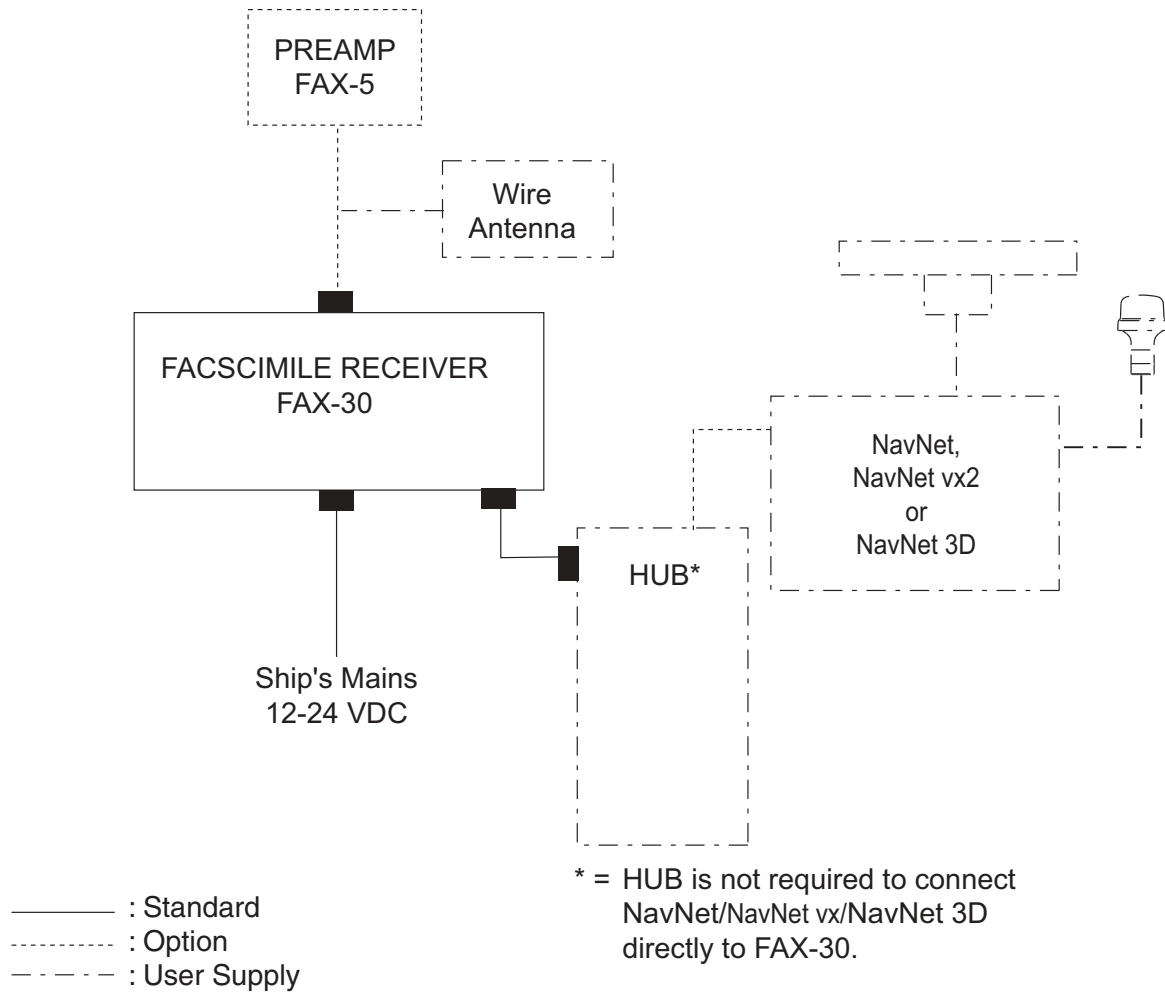

# PC installation

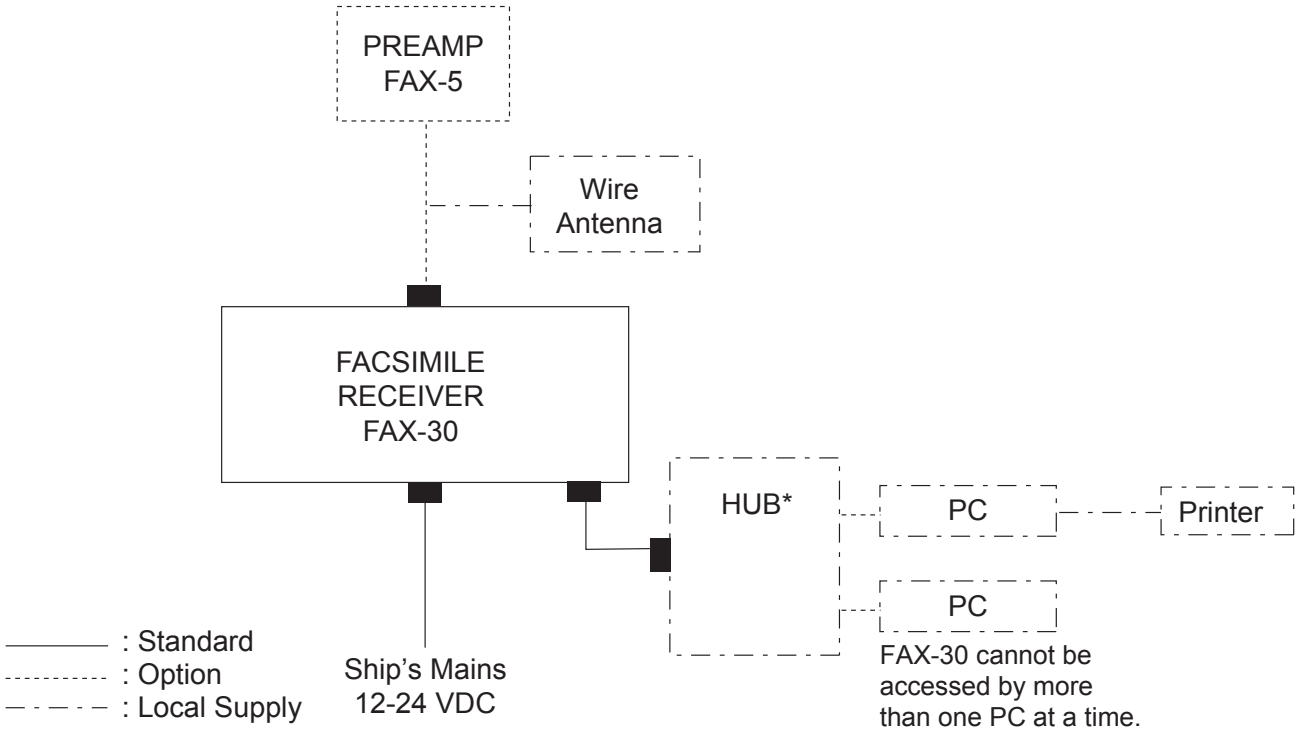

\* = HUB is not required to connect single PC.

# EQUIPMENT LISTS

---

## Standard supply

Name	Type	Code No.	Qty	Remarks
Facsimile Receiver	FAX-30-E-AN	—	Select one	With Net cable
	FAX-30-E-AP	—		With PC cable
	FAX-30-E-N	—		No connection cable
Spare Parts	SP08-01901	005-952-780	1 set	Fuse, 2 pcs.
Installation Materials	CP08-01700	000-057-103	Choose one	<ul style="list-style-type: none"> <li>• <u>Power Cable</u> MJ-A3SPF0024-035C</li> <li>• <u>Net Cable</u> MJ-A6SPF0014-050C</li> <li>• Tapping screw (5x20)</li> </ul>
	CP08-01710	000-057-104		<ul style="list-style-type: none"> <li>• <u>Power Cable</u> MJ-A3SPF0024-035C</li> <li>• <u>PC Cable</u> MJ-A6SPF0017-050C</li> <li>• Tapping screw (5x20)</li> </ul>
	CP08-01720	000-057-105		<ul style="list-style-type: none"> <li>• <u>Power Cable</u> MJ-A3SPF0024-035C</li> <li>• Tapping screw (5x20)</li> </ul>

## Optional supply

Name	Type	Code No.	Remarks	
Preamp Unit	FAX-5	000-075-016	w/15 m cable	
Preamp Unit	FAX-5	000-075-049	w/1 m cable	
Hose Clamp	OP08-11	005-946-960	For fixing FAX-5 to a mast	
Whip Antenna	04S4176	000-153-122	2.6 m, for FAX-5	
Extension Cable Kit	OP-04-2 *10*	000-041-174	M-connector at both ends	
	OP-04-2 *20*	000-041-175		
	OP-04-2 *30*	000-041-176		
	OP-04-2 *40*	000-041-177		
	OP-04-2 *50*	000-041-178		
Cable Assy.	MJA6SRMD/TM11AP8-005	000-144-463	Net conversion cable, for HUB, NavNet	
Cable Assy.	MJ-A6SPF0017-050C	000-159-705-11	Net conversion cable, for HUB, PC	
Coaxial Plug	FM-MP-7	000-161-293-10	For cable 7C2V, RG8/U, etc.	
Adaptor	MP-M3A	000-161-295-10	For cable 3C2V, 3D2V, etc.	
Adaptor	MP-M5A	000-161-296-10	For cable 5C2V, 5D2V, etc.	
Cable Assy. MJ	MJ-A6SPF0014-010C	000-154-027-10	1 m	Net cable
	MJ-A6SPF0014-050C	000-154-049-10	5 m	
	MJ-A6SPF0014-100C	000-154-050-10	10 m	
	MJ-A6SPF0014-200C	000-154-051-10	20 m	
	MJ-A6SPF0014-300C	000-154-052-10	30 m	
Automatic Printing Software	FAX-30-APT	005-964-310		

*This page intentionally left blank.*

# 1. OVERVIEW, SETUP

## 1.1 Setup: NavNet and NavNet vx2

### 1.1.1 Controls

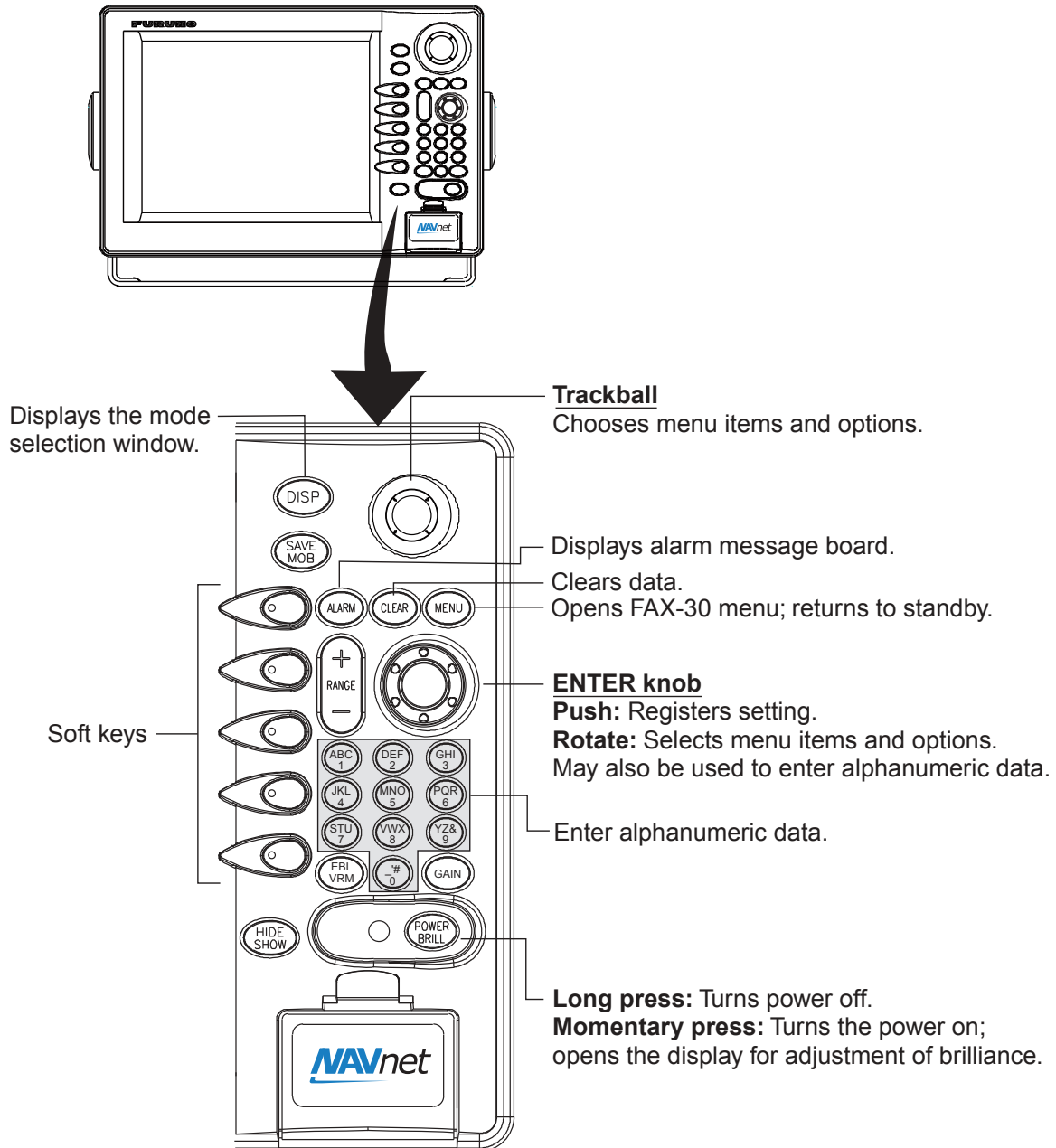

Controls

**Note 1:** For NavNet operating procedures, see the operator's manual of the NavNet display unit.

**Note 2:** The example screens shown in this manual may not match the screens you see. The screen you see depends on your equipment settings and system configuration.

### 1.1.2 Preparations for using the FAX-30

The NavNet series display unit must output the date and time data sentence ZDA through the network in order to use the facsimile timer recording feature. Further, automatic navtex requires the geographical position data sentence GGA (GPS position fix data) or GLL (geographic position, latitude/longitude). Output appropriate data sentences from the NavNet display unit to the FAX-30 as follows:

1. Turn on the NavNet display unit. From the radar, plotter or echo sounder display, press the [MENU] key.
2. Press the SYSTEM CONFIGURATION soft key.
3. Press the SYSTEM SETUP soft key.
4. Press the PORT SETUP soft key.
5. Press the OUTPUT THROUGH NETWORK soft key.

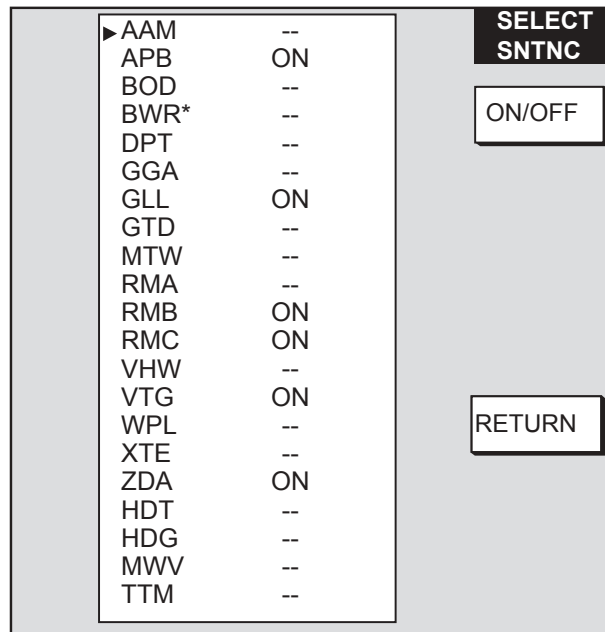

\*: BWR: Rhumb line  
 BWC: Great circle

*Select sentence window*

6. Rotate the [ENTER] knob to choose GGA, GLL or ZDA.
7. Press the ON/OFF soft key to display ON.
8. Repeat steps 6 and 7 to set the other two sentences to ON.
9. Press the [MENU] key to close the menu.

### 1.1.3 Accessing the FAX mode

1. Turn on the FAX-30 at the ship's mains switchboard. The FAX-30 proceeds in the following sequence:
  - a) The FAX-30 starts initial set up, which takes about 15 seconds.
  - b) The FAX-30 transfers (loads) data from the ROM to the RAM. At this time the LED flashes every 0.4 seconds.
  - c) After all data has been loaded, which takes about two minutes, the LED flashes every two seconds, indicating the FAX-30 is ready for operation.

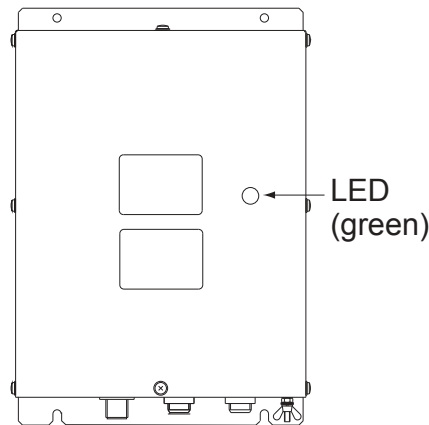

*FAX-30, top view*

2. Press the [DISP] key to show the display selection window.

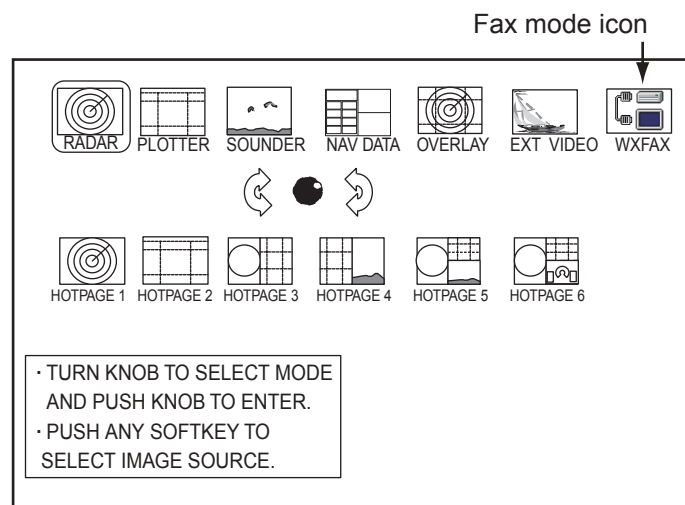

*Display selection window*

3. Rotate the [ENTER] knob to choose the WXFAX icon.
4. Push the [ENTER] knob to show the fax standby display.

**Note 1:** The FAX-30 cannot be accessed during the 15-second start up period that occurs after the power has been turned on.

**Note 2:** If the FAX-30 is not connected to the NavNet display unit when the display unit is powered, the message "AUX SOURCE IS DISCONNECTED. PUSH ENT KNOB TO EXIT." appears. Check connections between the FAX-30 and the NavNet display unit.

**Note 3:** "LOAD IMAGES" is displayed while the FAX-30 is loading data.

## 1. OVERVIEW, SETUP

The standby display is where you begin all facsimile and navtex operations. If a facsimile image has been received, the latest facsimile image is displayed.

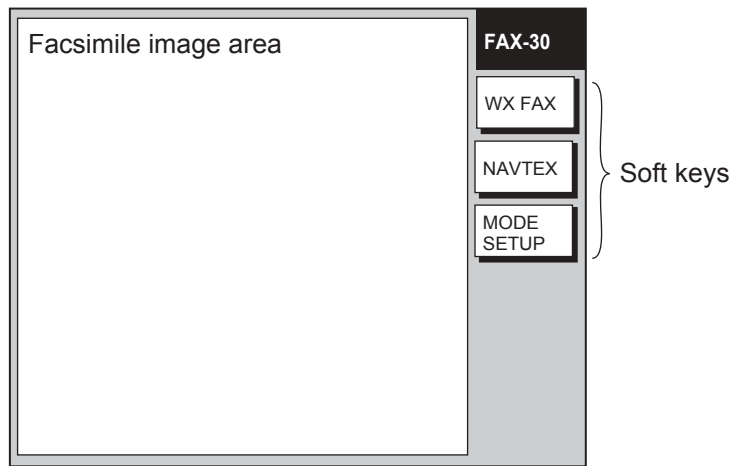

*Standby display*

### 1.1.4 Choosing the receive mode

The FAX-30 has three modes: facsimile only, navtex only, and facsimile (timer) & navtex. Choose desired mode as follows:

1. At the facsimile standby display, press the MODE SETUP soft key.

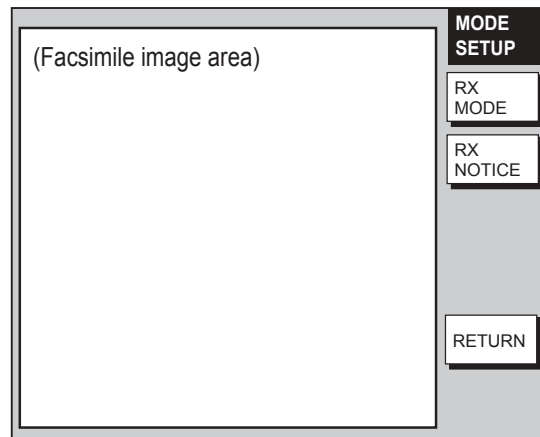

*Receive mode setup screen*

2. Press the RX MODE soft key.

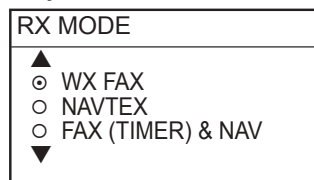

*RX mode options*

3. Rotate the [ENTER] knob to choose receive mode desired and press the ENTER soft key.

### 1.1.5 Receive notification

You may wish to be notified after a facsimile image or navtex message arrives. Notification is done by showing the “fax/navtex received” icon () at the left-hand side of the screen in display modes other than the fax mode.

1. At the facsimile standby display, press the MODE SETUP soft key.
2. Press the RX NOTICE soft key.

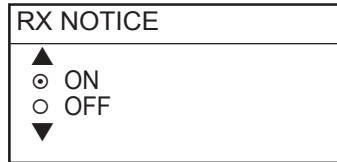

*RX notice options*

3. Rotate the [ENTER] knob to choose ON or OFF as appropriate.
4. Press the ENTER soft key.

## 1.2 Setup: PC

### 1.2.1 Accessing the FAX-30 top display

1. Turn on the FAX-30 at the breaker on switchboard. The FAX-30 proceeds in the following sequence:
  - a) The FAX-30 starts initial set up, which takes about 15 seconds.
  - b) The FAX-30 transfers (loads) data from the ROM to the RAM. At this time the LED flashes every 0.4 seconds.
  - c) After all data has been loaded, which takes about two minutes, the LED flashes every two seconds, indicating the FAX-30 is ready for operation.
2. Start up the browser software.
3. After the LED on the FAX-30 starts flashing every two seconds, type in the FAX-30's URL <http://172.31.8.1> and then press the [Enter] key. The facsimile receiver top display appears. (For one-touch access to the FAX-30 make a bookmark.)



*Facsimile receiver top display*

4. Click WX FAX for facsimile or NAVTEX for navtex to show the corresponding standby display, which is where you begin all facsimile (or navtex) operations.

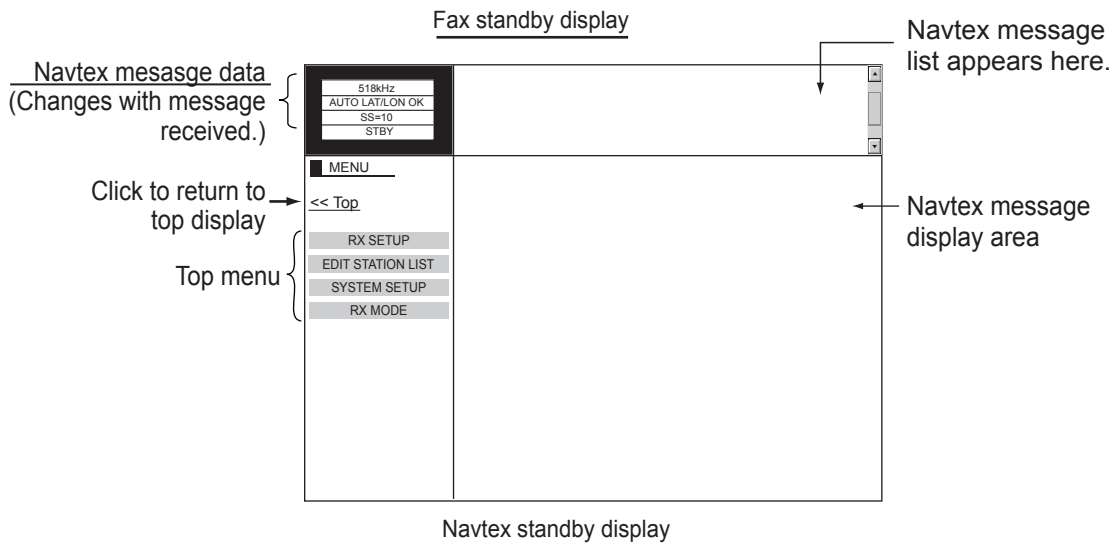
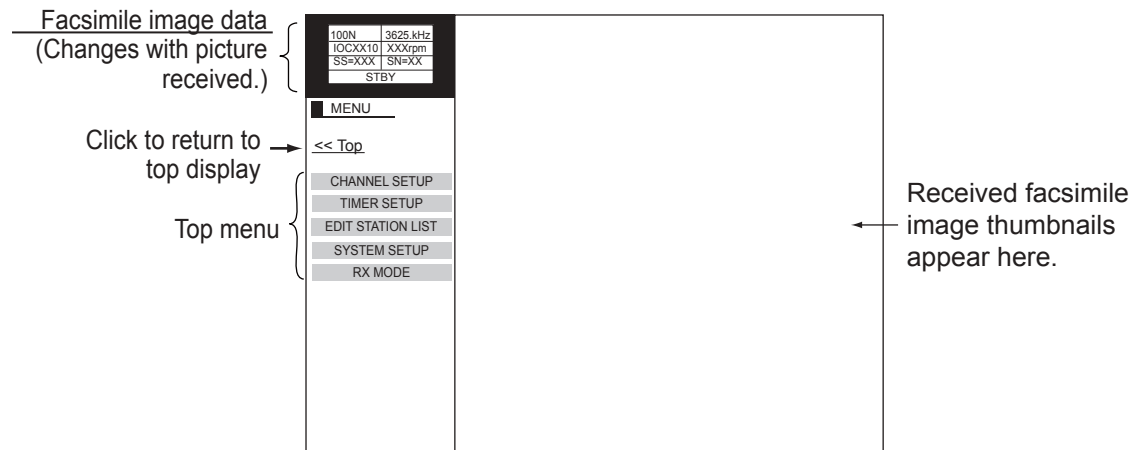

*Standby displays*

After you are in a standby display time data is transferred from the PC to the FAX-30.

**Note 1:** After turning on the FAX-30 be sure to access it from the PC. Then, even if the PC is turned off, time data is stored in the FAX-30, for use with timer recording.

**Note 2:** The example screens shown in this manual may not match the screens you see. The screen you see depends on your equipment settings and system configuration.

### 1.2.2 Choosing the receive mode

The FAX-30 has three modes: facsimile only, navtex only, and facsimile (timer) & navtex. Choose desired mode as follows.

1. At the facsimile or navtex standby display, click RX MODE.

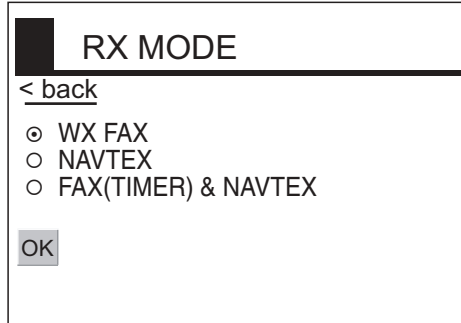

*RX mode options*

2. Click desired receive mode and then click OK.
3. Click "<back" or Back button to return to the top menu.

### 1.2.3 Logging out

The FAX-30 cannot be accessed simultaneously by multiple PCs or NavNet/NavNet 3D units. For this reason, log out a PC or NavNet/NavNet 3D from the FAX-30 when its use is not required.

1. At the facsimile or navtex menu display, click "<Top" to return to the facsimile receiver top display. (See the illustration at the top of the previous page.)
2. Click LOGOUT to logout the PC or NavNet/NavNet 3D from FAX-30.

## 1.3 Setup: NavNet 3D



### 1.3.1 Controls



MFD12 (MFD8 is similar), DCU12



MCU-001

No.	Control	Description
1	 BRILL (MFD8/12, DCU12)  (MCU-001)	Momentary push: Turn ON the power; adjust brilliance (MFD8/12, DCU12). Long push: Turn OFF the power.
2	DISP	Select a display.
3	CANCEL	Cancel an operation; revert to last-used setting.
4	CursorPad	Pad: Move Cursor  : Like Left-button click on PC
5	MENU	Open and close the menu.

### 1.3.2 How to use FAX-30 with NavNet 3D

Connect the FAX-30 to the NavNet 3D. If the IP address of the FAX-30 has been changed, restore the IP address to [172.31.8.1]. For how to open the installation wizard, see the installation manual for the NavNet 3D.

1. Turn on the FAX-30 at the switchboard. (The FAX-30 does not have a power switch.) Check if the power is on or the unit is disconnected, by monitoring the LED.
  - a) The initialization of the FAX-30 takes approximately 15 seconds.
  - b) Data is transferred from the ROM to the RAM. At this time the LED flashes every 0.4 seconds.
  - c) It takes about two minutes to send data. The LED blinks every two seconds when the FAX-30 is available for operation.
2. Push the [DISP] key.
3. Push the RotoKey™ until the display selection window, shown below, appears.

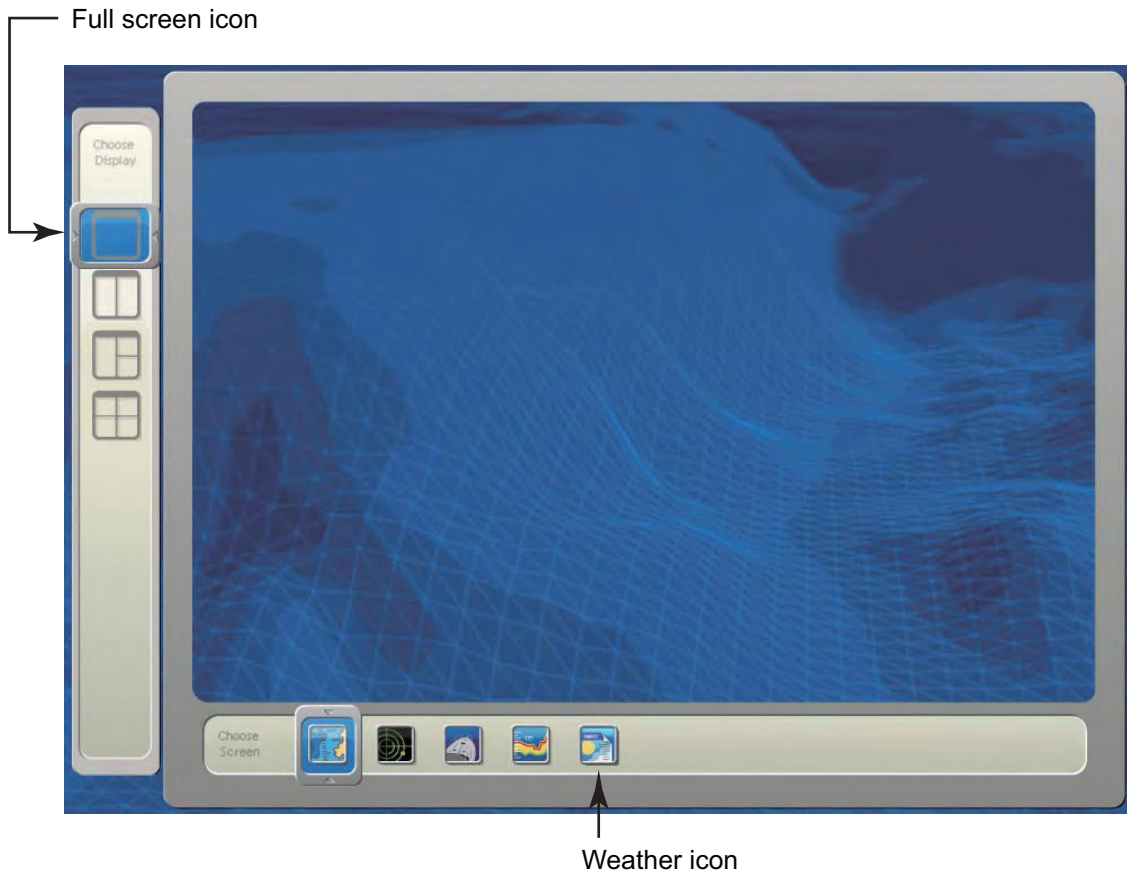

4. The selector at the left side of the screen is choosing the "full screen" icon. Push the RotoKey™ to choose the full screen icon.
5. Rotate the RotoKey™ to choose the Weather icon at the bottom of the display and then push the RotoKey™.
6. Use the [DISP] key and the RotoKey™ to select the Weather display.

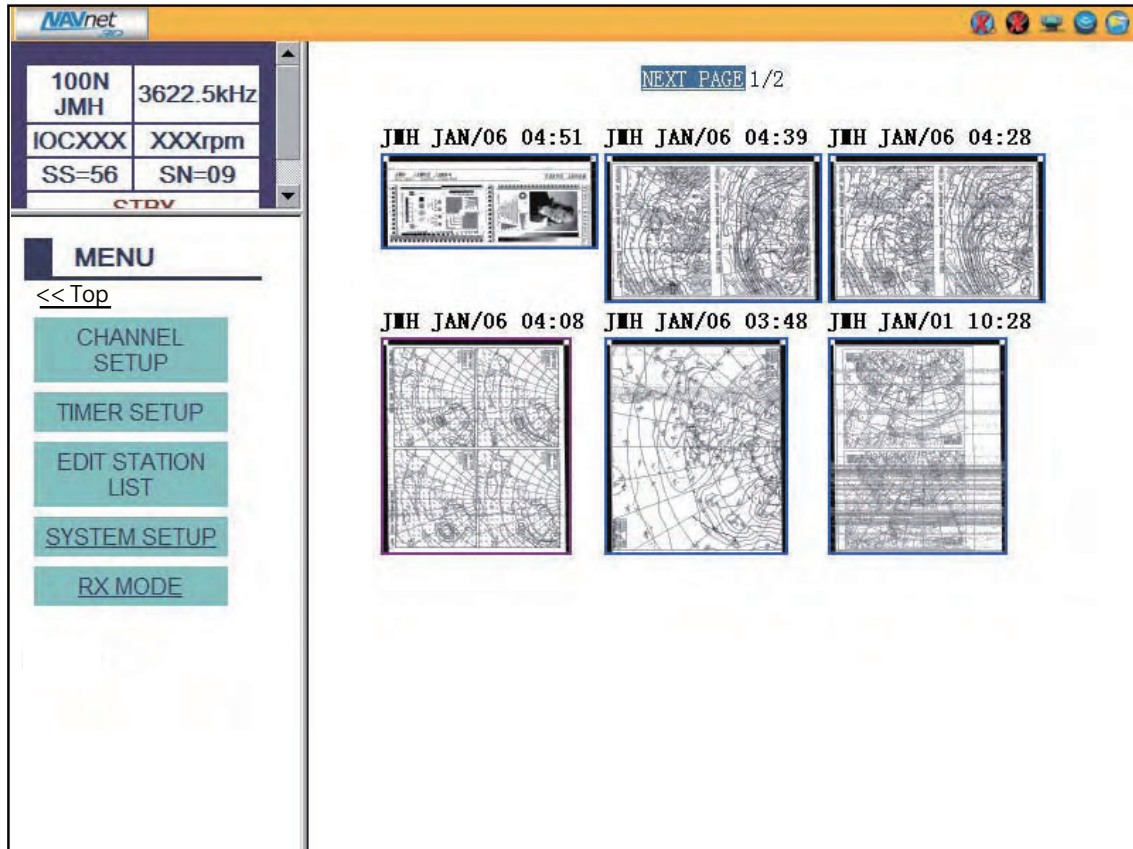

### 1.3.3 Receive mode

The FAX-30 has three receiving modes: WX FAX, NAVTEX, and FAX&NAVTEX.

1. Click RX MODE on the FAX-30 display.

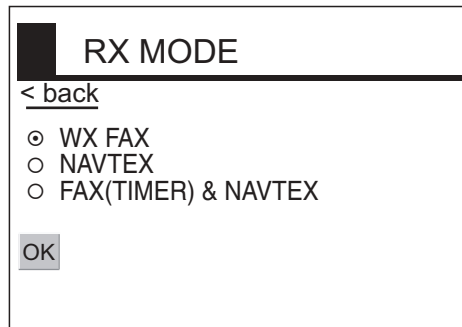

2. Click desired receive mode and then click OK.
3. Click "back" to finish.

### 1.3.4 Logout

The FAX-30 cannot be accessed from more than one NavNet 3D unit at a time. Therefore, logout from a unit you are not using to enable access from other units.

1. Click Top on the FAX-30.
2. Click LOGOUT.

## 2. FAX OPERATION: NavNet, NavNet vx2

---

### 2.1 Automatic Receiving

Once you choose the facsimile station from which to receive, the system goes into standby to await the start signal from the facsimile station.

#### 2.1.1 Choosing channel

1. At the standby display, press the WX FAX soft key. Thumbnails of received images are shown.

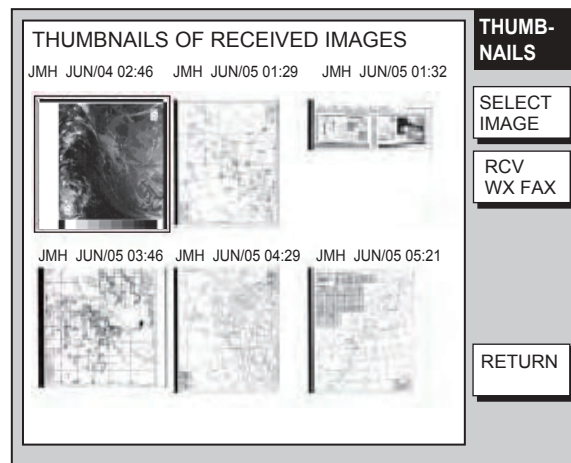

*Thumbnails of received images*

2. Press the RCV WX FAX soft key.

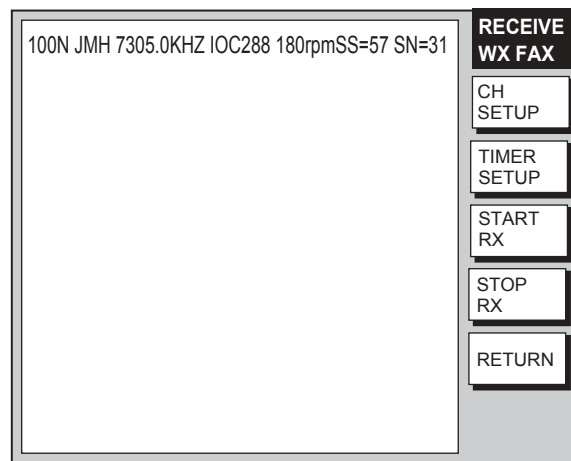

*RECEIVE WX FAX display*

## 2. FAX OPERATION: NAVNET

3. Press the CH SETUP soft key.

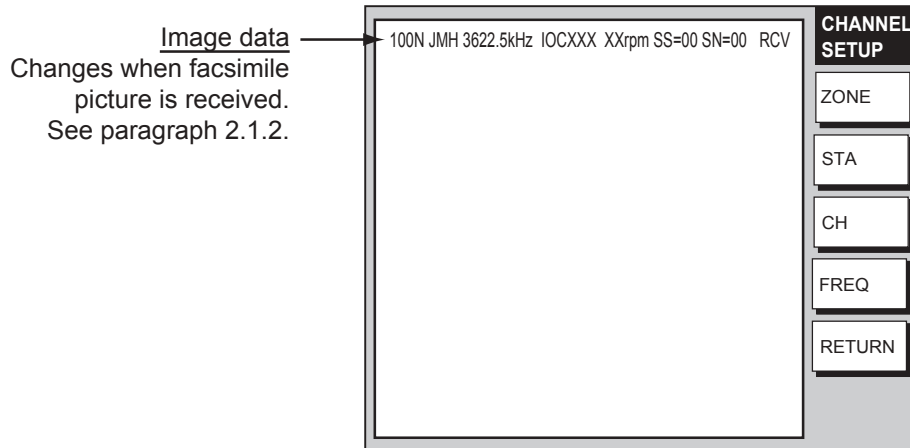

*Fax channel setup window*

4. Press the ZONE soft key to display the ZONE options.

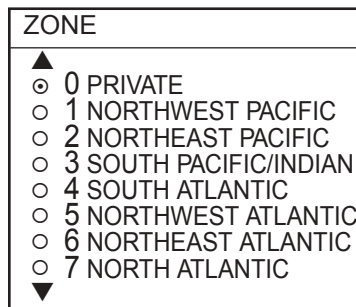

*Zone options*

5. Rotate the [ENTER] knob to choose zone desired and push the ENTER soft key. (Zone 0 and 9 are for user-set zones.)
6. Press the STATION soft key to show the STATION options. If the ZONE chosen at step 5 is "1 NORTHWEST PACIFIC," for example, the STATION options are as below.

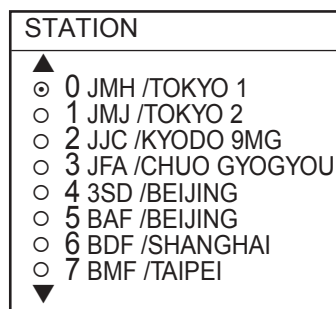

*Station options (Example: stations of northwest pacific)*

7. Rotate the [ENTER] knob to choose desired station and press the ENTER soft key.

8. Press the CHANNEL soft key to show the CHANNEL options. If you have chosen "0 JMH/TOKYO 1" at step 7, for example, the CHANNEL options are as below.

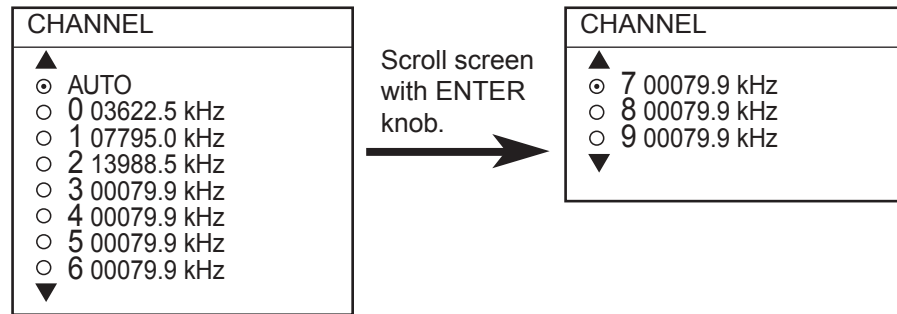

*Channel options (Example: JMH/Tokyo)*

9. Rotate the [ENTER] knob to choose channel desired and press the ENTER soft key.  
 10. If necessary you may fine-tune the frequency. Press the FREQ soft key.

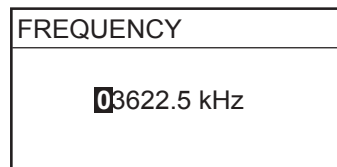

*Frequency entry window*

11. Use the alphanumeric keys or the [ENTER] knob to enter appropriate frequency and press the ENTER soft key. (You may choose the location where to enter data by operating the trackball.)  
 12. Press the RETURN soft key several times to return to the standby display.

Then, the FAX-30 will receive the next scheduled broadcast from the station selected. When the FAX-30 receives the start signal from the facsimile station it automatically adjusts itself to match speed, IOC (Index of Cooperation) and phase of the station's transmitter. Facsimile images are received line by line, taking 30-40 minutes to receive depending on the size of the image and rotation speed of the drum at the facsimile transmitter. After a facsimile image is received it is compressed and stored in image memory and then posted on the "Thumbnails of received images" screen (see paragraph 2.4). This process takes from three to five minutes. You can see the image being received by pressing the WX FAX soft key on the fax standby display and then hitting the RCV WX FAX soft key.

### 2.1.2 Previewing image being received

To preview an image while it is being received, do the following:

1. At the fax standby display, press the WX FAX soft key.
2. Press the RCV WX FAX soft key.

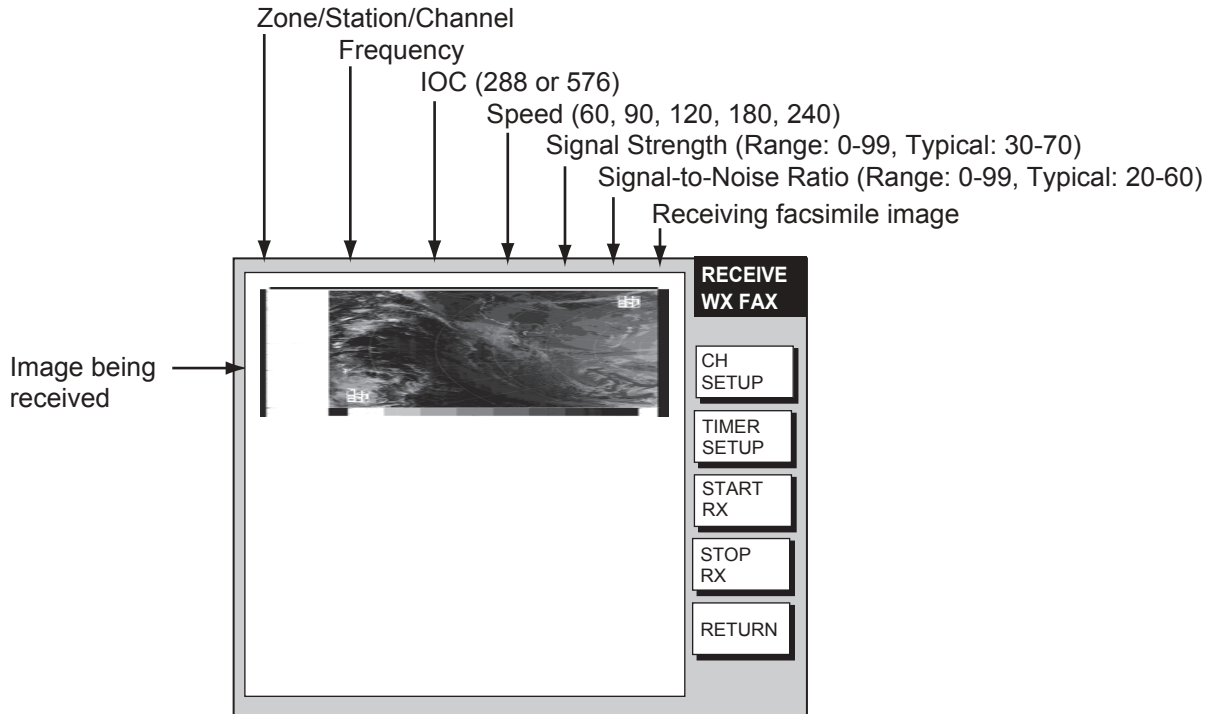

*Facsimile receiving display*

### 2.1.3 Stopping automatic receiving

You can stop automatic receiving at any time by doing the following:

1. At the standby display, press the WX FAX soft key.
2. Press the RCV WX FAX soft key.
3. Press the STOP RX soft key. The indication "RCV" is replaced with "STBY."
4. Press the RETURN soft key.

## 2.2 Manually Starting, Stopping Receiving

### 2.2.1 Manually starting receiving

This section shows you to manually receive a facsimile broadcast. For example, you may want to receive a facsimile broadcast already in progress or receive from a facsimile station that does not use start and stop signals. Further, you may wish to stop reception to receive an image from a different station.

To manually receive a facsimile, you will first need to set a channel, referring to paragraph 2.1. Then, do the following:

1. At the standby display, press the WX FAX soft key.
2. Press the RCV WX FAX soft key.
3. Press the START RX soft key.

The options shown are IOC (Index of Cooperation)/speed.

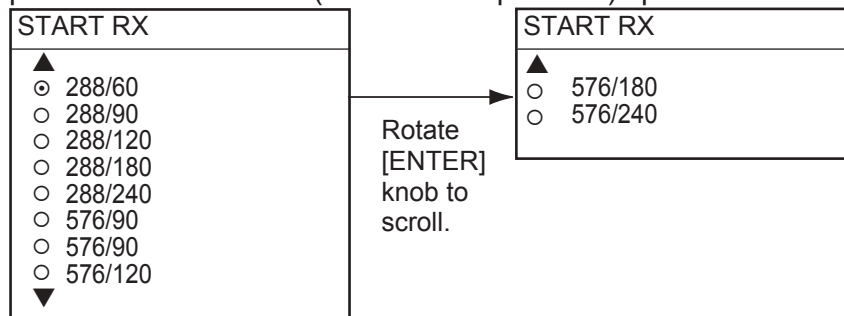

*Start RX options*

4. Rotate the [ENTER] knob to choose the correct combination of IOC and speed of the facsimile transmitting station. IOC is the line density standard assigned by WMO: IOC 576, high density, IOC 288, low density. Speed is the rotation speed of the drum (on which the original image is fitted) at the facsimile transmitter: 60, 90, 120, 180 or 240 rpm.
5. Press the ENTER soft key.
6. Press the RETURN soft key.

Then, the FAX-30 will receive the current broadcast from the station selected. Facsimile images are received line by line, taking 30-40 minutes to receive depending on the size of the image and drum rotation speed at the facsimile station. After a facsimile image is received it is compressed and stored in the image memory and then posted on the "Thumbnails of received images" screen (see paragraph 2.4). This process takes 3-5 minutes. You can see the image being received by pressing the WX FAX soft key on the fax standby display and then hitting the RCV WX FAX soft key.

## 2. FAX OPERATION: NAVNET

Be sure to choose the correct speed and IOC, otherwise the image will be received as shown in the illustration below. You may change the IOC and speed while the image is being received.

### Wrong Speed or IOC and Image

#### Wrong speed: "60" chosen instead of "120"

Two images are displayed.

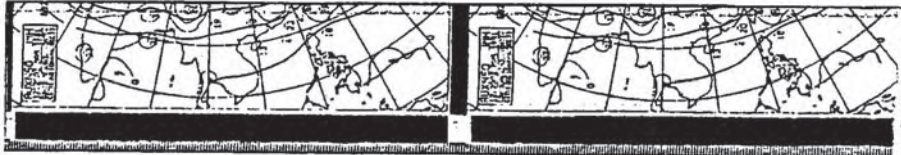

#### Wrong speed: "120" chosen instead of "60"

Overlapped image appears.



#### Wrong IOC

The image will be extended ( or foreshortened) when "288" (or 576 is selected for transmission with the IOC of "576 (or 288)."



*Wrong speed or IOC and image*

### 2.2.2 Manually stopping receiving

1. At the standby display, press the WX FAX soft key.
2. Press the RCV WX FAX soft key.
3. Press the STOP RX soft key.
4. Press the RETURN soft key.

## 2.3 Timer Receiving

Most facsimile stations transmit facsimiles in accordance with a schedule issued by relative meteorological observatory. (You can find facsimile schedules in the publication “Meteorological Facsimile Broadcasts,” available through meteorological observatory bodies.) If you wish to receive a certain facsimile broadcast on a daily basis, therefore, the timer receiving mode will virtually allow you “hands-off” automatic operation. 30 timer programs may be set.

### 2.3.1 Setting timer receiving schedule

Note that the data sentence ZDA must be output through the network for the timer to function.

1. At the standby display, press the WX FAX soft key.
2. Press the RCV WX FAX soft key.
3. Press the TIMER SETUP soft key.

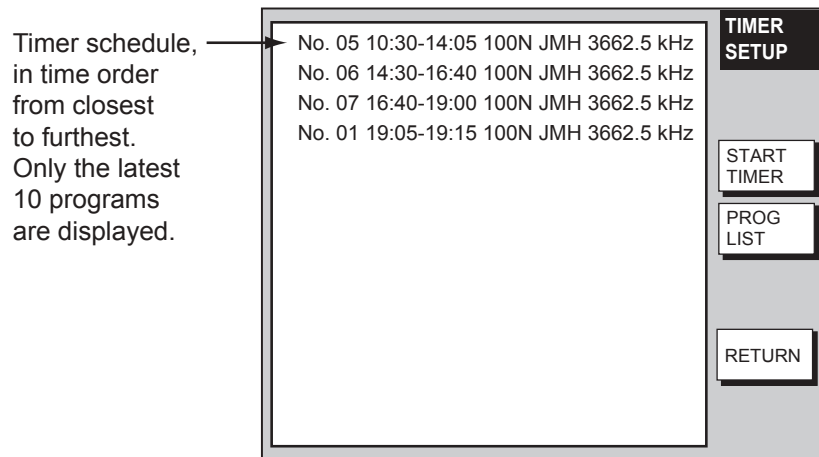

Timer setup screen

4. Press the PROG LIST soft key.

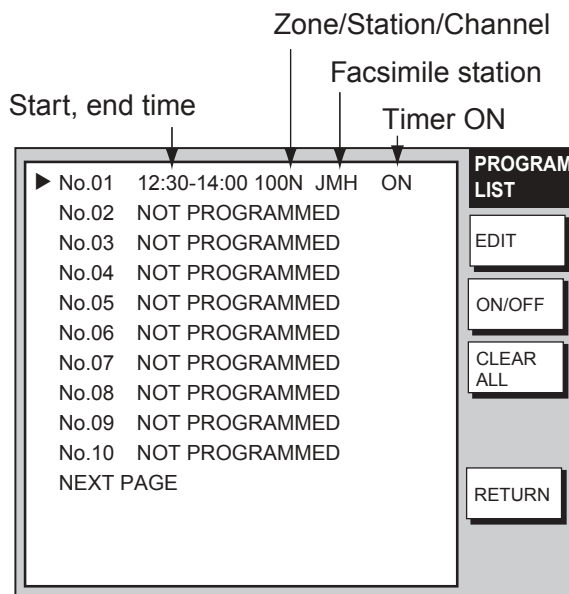

Timer schedule list

2. FAX OPERATION: NAVNET

5. Rotate the [ENTER] knob to choose program number desired and then press the EDIT soft key.

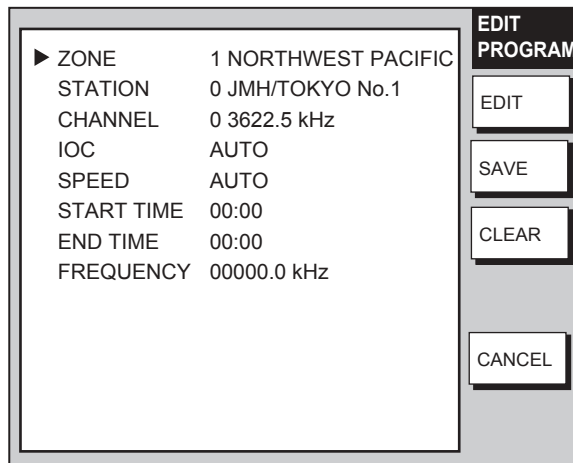

*Timer schedule menu*

6. ZONE is selected; press the EDIT soft key.

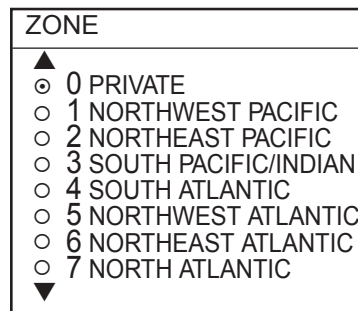

*Zone options*

7. Rotate the [ENTER] knob to choose zone desired and press the ENTER soft key.
8. Rotate the [ENTER] knob to choose STATION and press the EDIT soft key. If you have chosen "1 NORTHWEST PACIFIC" at step 7, for example, the STATION options are as below.

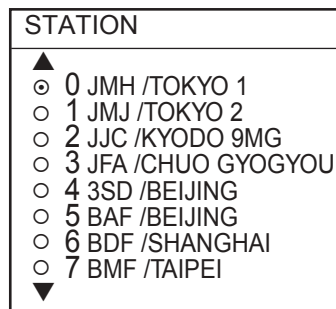

*Station options (Example: N Pacific W Part)*

9. Rotate the [ENTER] knob to choose desired station and press the ENTER soft key.

10. Rotate the [ENTER] knob to choose CHANNEL and press the EDIT soft key. If you have chosen "0 JMH/TOKYO 1" at step 9, for example, the CHANNEL display looks as below.

CHANNEL	
▲	
<input checked="" type="radio"/>	AUTO
<input type="radio"/>	0 03622.5 kHz
<input type="radio"/>	1 07795.0 kHz
<input type="radio"/>	2 13988.5 kHz
<input type="radio"/>	3 00079.9 kHz
<input type="radio"/>	4 00079.9 kHz
<input type="radio"/>	5 00079.9 kHz
<input type="radio"/>	6 00079.9 kHz
▼	

*Channel options (Example: station JMH)*

11. Rotate the [ENTER] knob to choose channel desired and press the ENTER soft key. Choose AUTO for automatic selection of channel. (Most stations transmit the same message over several frequencies, so if you are unsure of the channel choose AUTO.)
12. Rotate the [ENTER] knob to choose IOC and press the EDIT soft key.

IOC	
▲	
<input checked="" type="radio"/>	AUTO
<input type="radio"/>	288
<input type="radio"/>	576
▼	

*IOC options*

13. Rotate the [ENTER] knob to choose the IOC of the facsimile station and press the ENTER soft key. If you are unsure of the IOC, choose AUTO for automatic selection of IOC.
14. Rotate the [ENTER] knob to choose SPEED and press the EDIT soft key.

SPEED	
▲	
<input checked="" type="radio"/>	AUTO
<input type="radio"/>	60
<input type="radio"/>	90
<input type="radio"/>	120
<input type="radio"/>	180
<input type="radio"/>	240
▼	

*Drum speed options*

15. Rotate the [ENTER] knob to choose drum rotating speed at the facsimile station and press the ENTER soft key. If you are unsure of the speed, choose AUTO for automatic selection of speed.
16. Rotate the [ENTER] knob to choose START TIME and press the EDIT soft key.

START TIME	
00:00	

*Start time entry window*

## 2. FAX OPERATION: NAVNET

17. Enter a start time in 24-hour notation, about two minutes earlier than actual start time to allow for detection of the start signal and press the ENTER soft key.
18. Rotate the [ENTER] knob to choose END TIME and press the EDIT soft key.

END TIME
<input type="text" value="00:00"/>

*End time entry window*

19. Enter end time in 24-hour notation about two minutes later than actual end time to allow for detection of the stop signal, and press the ENTER soft key.  
**Note:** Two programs that overlap each other will cause the program having the later start time to be disregarded. For example, if the start and end times of program no. 1 are 01:00 and 02:00 and those of program no. 2 are 01:30 to 3:00, program no. 2 will be disregarded.
20. If necessary you may fine-tune the receive frequency. Rotate the [ENTER] knob to choose FREQUENCY and press the EDIT soft key. The frequency selected at step 10 appears.

FREQUENCY
<input type="text" value="03522.5 kHz"/>

*Frequency entry window*

21. Enter frequency with the numeric keys and press the ENTER soft key.
22. Press the SAVE soft key.

SAVE
<input type="radio"/> YES <input checked="" type="radio"/> NO

*Save window*

23. Rotate the [ENTER] knob to choose YES and push the [ENTER] knob.
24. Repeat steps 4-23 to set other timer schedules.
25. Press the RETURN soft key.
26. Press the START TIMER soft key.

START TIMER
<input type="radio"/> START <input checked="" type="radio"/> STOP

*Start timer options*

26. Rotate the [ENTER] knob to choose START and press the ENTER soft key.
27. Press the RETURN soft key.

Then, the FAX-30 will receive facsimile broadcasts according to the timer schedule. Facsimile images are received line by line, taking 30-40 minutes to receive depending on the size of the image and drum rotation speed at the facsimile station. After a facsimile image is received it is compressed and stored in the image memory and then posted on the facsimile standby display screen. This process takes 3-5 minutes. You can see the image being received by pressing the WX FAX soft key on the fax standby display and then hitting the RCV WX FAX soft key.

**Note:** To disable all timer programs do the following:

1. At the standby display, press the WX FAX soft key.
2. Press the RCV WX FAX soft key.
3. Press the TIMER SETUP soft key.
4. Rotate the [ENTER] knob to choose STOP.
5. Press the ENTER soft key.
6. Press the RETURN soft key.

### 2.3.2 Turning on/off specific timer programs

You may turn specific timer programs on or off as appropriate as follows:

1. At the standby display, press the WX FAX soft key.
2. Press the RCV WX FAX soft key.
3. Press the TIMER SETUP soft key.
4. Press the PROG LIST soft key.
5. Rotate the [ENTER] knob to choose a timer receiving schedule.
6. Press the ON/OFF soft key to display ON or OFF next to timer program data.
7. Press the RETURN soft key several times to return to the standby display.

### 2.3.3 Clearing all timer programs

You may clear all timer programs as follows:

1. At the standby display, press the WX FAX soft key.
2. Press the RCV WX FAX soft key.
3. Press the TIMER SETUP soft key.
4. Press the PROG LIST soft key.
5. Press the CLEAR ALL soft key.

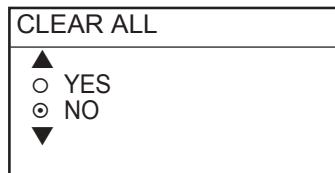

*Clear all options*

6. Rotate the [ENTER] knob to choose YES and push the ENTER knob.  
All timer programs disappear.
7. Press the RETURN soft key several times to return to the standby display.

## 2.4 Displaying Facsimile Images

- At the standby display, press the WX FAX soft key. Thumbnails of images received are shown on the display. The equipment stores as many as 12 images, on two pages. If more than six images are stored, PREV PAGE and NEXT PAGE soft keys appear in order to navigate between pages. When the image storage capacity is exceeded, the oldest image is automatically deleted to make room for the latest.

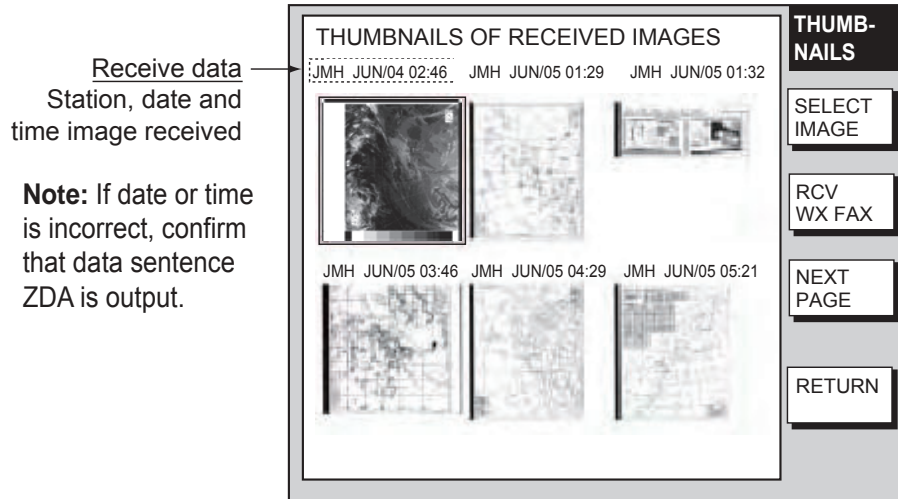

*Thumbnails of received images*

- Use the [ENTER] knob to select the facsimile image to process and then press the SELECT IMAGE soft key or push the [ENTER] knob. You can scroll the image with the trackball.

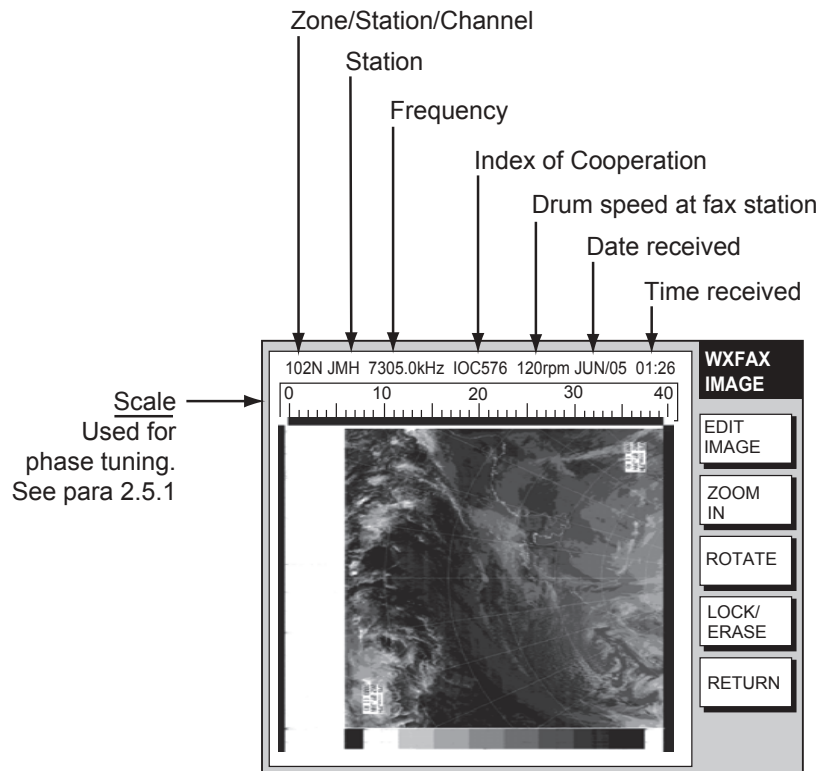

*Facsimile image*

## 2.5 Processing Facsimile Images

### 2.5.1 Phase mismatch

When the FAX-30 starts receiving a broadcast already in progress, or noise prevents detection of the phasing signal, the image may be divided into two parts by a thick black (or white) stripe called a dead sector. This phenomenon is due to phase mismatching. When this occurs, correct phase mismatching, after the facsimile has been received.

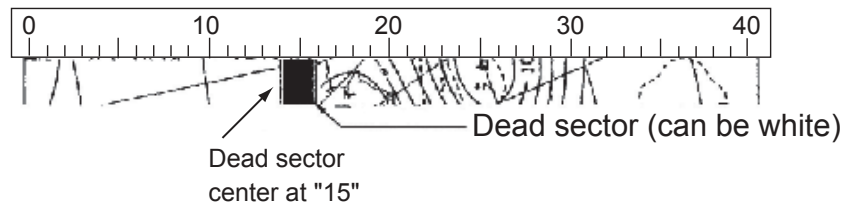

*Example of phase mismatching*

1. With a facsimile image displayed (see paragraph 2.4), press the EDIT IMAGE soft key.

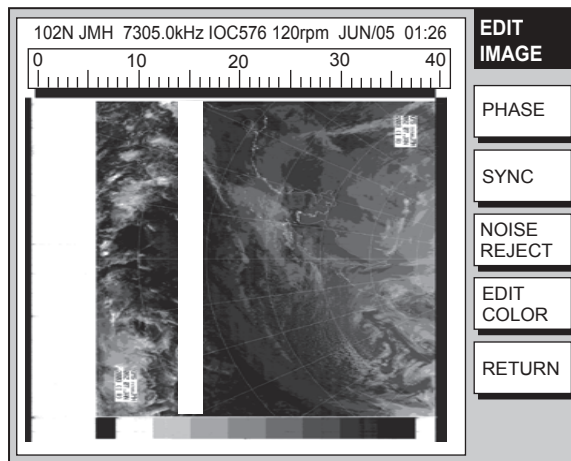

*Facsimile image with dead sector*

2. Press the PHASE soft key.

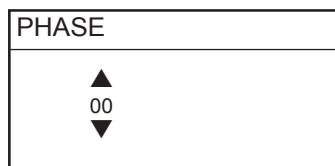

*Phase entry window*

3. Read the scale to find the center of the dead sector and enter it in the phase entry window. For example, in the illustration above the dead sector is centered at "15" on the scale, so you would enter "15". The setting range is 00 to 40.
4. Press the ENTER soft key.
5. Press the RETURN soft key several times to return to the standby display.

### 2.5.2 Phasing signal out of synchronization

The SYNC soft key functions to fine-tune the phasing signal. If the dead sector is plotted at an angle even when the phase is properly selected, adjust the synchronization to display the dead sector straightly.

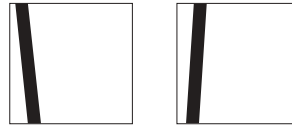

*Example of phasing signal out of synchronization*

1. With a facsimile image displayed (see paragraph 2.4), press the EDIT IMAGE soft key.
2. Press the SYNC soft key.

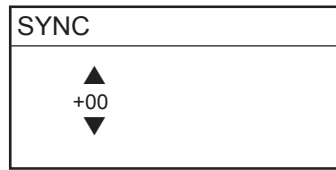

*Sync entry window*

3. Enter a sync value that displays the dead sector straightly. If the dead sectors appears as in the left-hand figure in example of phasing signals in the illustration above, enter a larger value and for the right-hand figure, enter a smaller value. The setting range is -50 to +50.
4. Press the ENTER soft key.
5. Press the RETURN soft key several times to return to the standby display.

### 2.5.3 Noise rejection

If noise speckles appear on the image, turn on the noise rejector as below to remove the noise.

1. With a facsimile image displayed (see paragraph 2.4), press the EDIT IMAGE soft key.
2. Press the NOISE REJECT soft key.

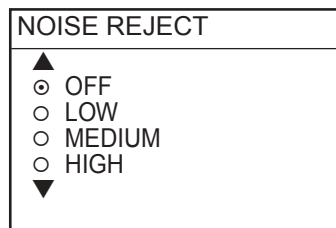

*Noise rejector options*

3. Rotate the [ENTER] knob to choose the noise rejection level desired. HIGH provides the greatest degree of noise rejection.
4. Press the ENTER soft key.
5. Press the RETURN soft key several times to return to the standby display.

### 2.5.4 Image color

The facsimile image is transmitted in monochrome (black and white) or gray scale (16 gradations). After an image has been received, you can choose the color arrangement among monochrome, gray scale and color (three patterns).

1. With a facsimile image displayed (see paragraph 2.4), press the EDIT IMAGE soft key.
2. Press the EDIT COLOR soft key.
3. Press the COLOR soft key.

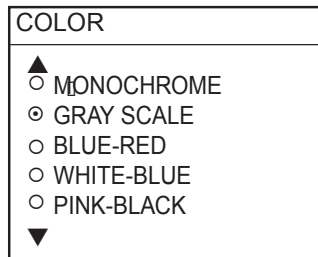

#### *Color options*

4. Rotate the [ENTER] knob to choose MONOCHROME, GRAY SCALE, BLUE-RED, WHITE-BLUE or PINK-BLACK as appropriate.

MONOCHROME: Monochrome black and white

GRAY SCALE: 16 gray tones

BLUE-RED: Shades of blue to red

WHITE-BLUE: Shades of white to blue

PINK-BLACK: Shades of pink to black

5. Press the ENTER soft key.
6. Press the RETURN soft keys several times to return to the standby display.

### 2.5.5 Image format

The facsimile image is usually transmitted with black text on a white background. Some stations, however, print white characters on a black background. If, for some reason, the image received cannot be read in its transmitted image format you may change it as follows:

1. With a facsimile image displayed (see paragraph 2.4), press the EDIT IMAGE soft key.
2. Press the EDIT COLOR soft key.
3. Press the REVERSE IMAGE soft key.

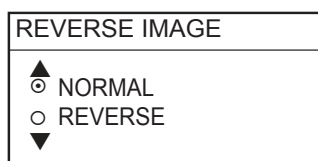

#### *Reverse image options*

4. Rotate the [ENTER] knob to choose NORMAL or REVERSE as appropriate.
5. Press the ENTER soft key.
6. Press the RETURN soft key several times to return to the standby display.

### 2.5.6 Zooming images

You may double the size of a facsimile image as follows:

1. Display the facsimile image you wish to process, referring to paragraph 2.4.
2. Press the ZOOM IN soft key.

To restore the normal size image, press the ZOOM OUT key.

### 2.5.7 Rotating images

You may rotate facsimile images as follows:

1. Display the facsimile image you wish to process, referring to paragraph 2.4.
2. Press the ROTATE soft key.
3. Press the CW (Clockwise) soft key to rotate the image 90° clockwise; CCW (Counterclockwise) soft key to rotate it 90° counterclockwise.

## 2.6 Erasing Facsimile Images

You may erase facsimile images as below.

1. Press the WX FAX key at the standby display.
2. Rotate the [ENTER] knob to select an image.
3. Push the [ENTER] knob or press the SELECT IMAGE soft key.

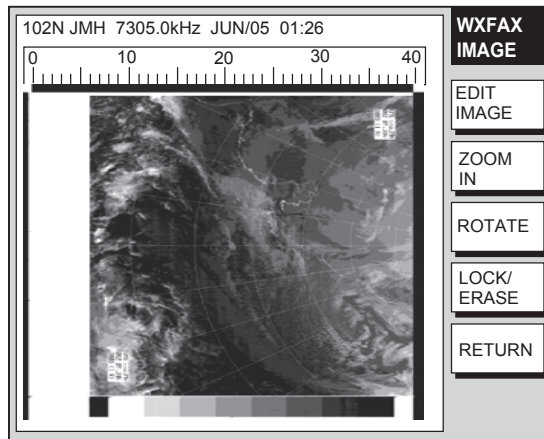

*Facsimile image*

4. Press the LOCK/ERASE soft key followed by the ERASE IMAGE soft key.

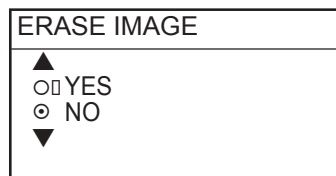

*Erase image options*

5. Rotate the [ENTER] knob to choose YES and press the ENTER soft key.
6. Press the RETURN soft key several times to return to the standby display.

## 2.7 Preventing Erasure of Facsimile Images

When facsimile image storage capacity is exceeded, the oldest facsimile image is erased to make room for the latest. If you have an image that you want to keep, you can prevent its erasure by using the “lock image” feature. You can lock all images, however you may not be able to receive a new image if there is not sufficient memory remaining to store the new image.

1. Press the WX FAX key at the standby display.
2. Rotate the [ENTER] knob to select an image and then push the [ENTER] knob or press the SELECT IMAGE soft key.
3. Press the LOCK/ERASE soft key followed by the LOCK IMAGE soft key.
4. Rotate the [ENTER] knob to choose ON and press the ENTER soft key.
5. Press the RETURN soft key several times to return to the standby display.

The locked image's data appears in red at the THUMBNAILS OF RECEIVED IMAGES screen. To release the lock image feature for a particular image, choose OFF at the step 4 in the above procedure.

## 2.8 Adding Facsimile Channels

The FAX-30 provides a free memory for the user to store 320 channels.

1. Press the [MENU] key to show the FAX-30 menu.

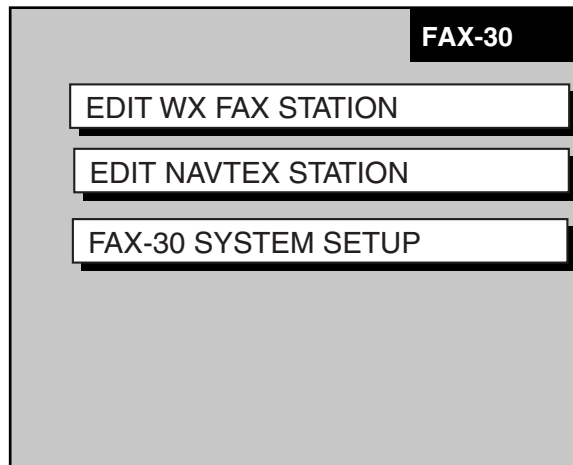

*FAX-30 top*

2. Press the EDIT WX FAX STATION soft key.

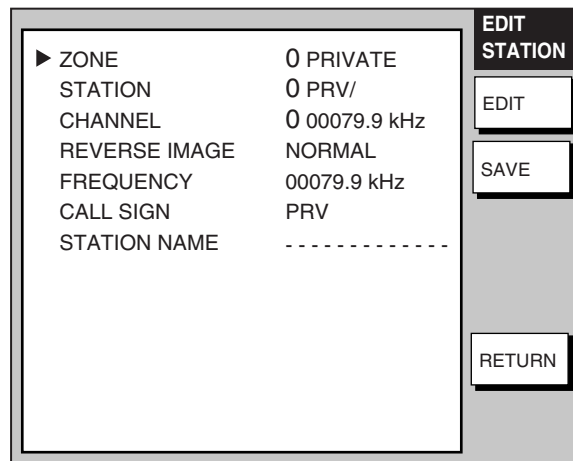

*Edit facsimile station menu*

3. ZONE is selected; press the EDIT soft key.

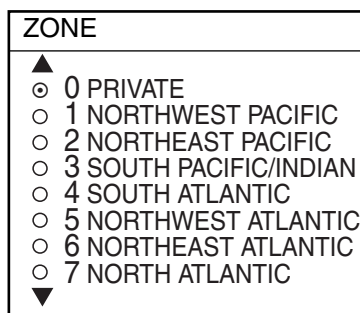

*Zone options*

4. Rotate the [ENTER] knob to choose a zone and push the EDIT soft key. (Zone 0 and 9 are for user zones.)

5. Rotate the [ENTER] knob to choose STATION and press the EDIT soft key. If the ZONE chosen at step 4 is "1 NORTHWEST PACIFIC," for example, the STATION options are as below.

STATION	
▲	
⊙	0 JMH /TOKYO 1
○	1 JMJ /TOKYO 2
○	2 JJC /KYODO 9MG
○	3 JFA /CHUO GYOGYOU
○	4 3SD /BEIJING
○	5 BAF /BEIJING
○	6 BDF /SHANGHAI
○	7 BMF /TAIPEI
▼	

*Station options (Example: stations of northwest pacific)*

6. Rotate the [ENTER] knob to choose a station and press the ENTER soft key.  
 7. Rotate the [ENTER] knob to choose CHANNEL and press the EDIT soft key. If the station chosen at step 8 is "0 JMH/TOKYO No.1," for example, the CHANNEL options are as below.

CHANNEL	
▲	
⊙	AUTO
○	0 03622.5 kHz
○	1 07795.0 kHz
○	2 13988.5 kHz
○	3 00079.9 kHz
○	4 00079.9 kHz
○	5 00079.9 kHz
○	6 00079.9 kHz
▼	

*Channel options (Example: JMH/Tokyo)*

8. Rotate the [ENTER] knob to choose a channel and press the ENTER soft key.  
 9. Rotate the [ENTER] knob to choose REVERSE IMAGE and press the EDIT soft key.

REVERSE IMAGE	
▲	
⊙	NORMAL
○	REVERSE
▼	

*Reverse image options*

10. The normal facsimile image format has black text on a white background. Some stations, however, print white characters on a black background. This information is programmed into the memory thus you need not designate image format. However, if you are entering frequency data of a newly established station whose image format is reverse of the normal image, rotate the [ENTER] knob to choose REVERSE. Press the ENTER soft key after making your selection.

## 2. FAX OPERATION: NAVNET

11. If you want to enter a frequency, call sign or station name other than that shown at CHANNEL and STATION, respectively, rotate the [ENTER] knob to choose FREQUENCY, CALL SIGN or STATION NAME as appropriate and press the EDIT soft key. One of the following displays appears depending on your selection.

FREQUENCY	CALL SIGN	STATION NAME
00003.4 kHz	JMH	TOKYO
Frequency	Call Sign	Station Name

*Frequency, call sign and station name entry windows*

12. Use the alphanumeric keys or the [ENTER] knob to enter appropriate data and press the ENTER soft key. You can shift the cursor by rotating the trackball.
13. Press the SAVE soft key.
14. Rotate the trackball to choose YES and then push the [ENTER] knob.
15. Press the [MENU] key to close the menu.

## 3. FAX OPERATION: NavNet 3D, PC

### 3.1 Automatic Receiving

#### 3.1.1 Starting receiving

1. At the facsimile standby display, click CHANNEL SETUP on the top menu.

CHANNEL SETUP

< back

ZONE 1: NORTHWEST PACIFIC

STATION 0: JMH/TOKYO 1

CHANNEL AUTO

FREQUENCY 03622.5 kHz

OK

RCV STOP

*Channel setup menu*

2. Click the arrow button on ZONE and choose desired zone.
3. Click the arrow button on STATION and choose desired station. See page AP-2 for station number.
4. Click the arrow button on CHANNEL and choose desired channel. Choose AUTO if you are unsure of channel. (Most stations transmit the same message over several frequencies, so if you are unsure of the channel choose AUTO.)
5. If necessary you may fine-tune the frequency. Click anywhere inside the FREQUENCY box and enter frequency. For a PC, enter numeric value from the keyboard.
6. Click OK and then click "<back" or Back button to return to the top menu.

Then, the FAX-30 will receive the next scheduled broadcast from the station selected. When the FAX-30 receives the start signal from the facsimile station it automatically adjusts itself to match speed, IOC (Index of Cooperation) and phase of the station's transmitter. Facsimile images are received, taking 30-40 minutes to receive depending on the size of the image. After a facsimile image is received it is compressed and stored in the image memory and then posted on the facsimile standby display screen. This process takes 3-5 minutes.

#### 3.1.2 Stopping receiving

You may stop receiving at any time by doing the following:

1. At the facsimile standby display, click CHANNEL SETUP on the top menu.
2. Click RCV STOP.

## 3.2 Timer Receiving

Most facsimile stations transmit facsimile signals in accordance with a schedule issued by relative meteorological observatory. (You can find facsimile schedules in the publication “Meteorological Facsimile Broadcasts,” available through meteorological observatory bodies.) If you wish to receive a certain facsimile broadcast on a daily basis, therefore, the timer receiving mode will virtually allow you “hands-off” automatic operation. 30 timer programs may be set.

### 3.2.1 Setting, changing timer receiving schedule

1. At the facsimile standby display, click TIMER SETUP followed by PROGRAM LIST to show the timer schedule.

No.	Start, end time	Facsimile station TX frequency of facsimile station	ON/OFF
1	12:30-14:00	100N JMH 3662.5kHz	ON
2	NOT PROGRAMMED		OFF
3	NOT PROGRAMMED		OFF
4	NOT PROGRAMMED		OFF
5	NOT PROGRAMMED		OFF
6	NOT PROGRAMMED		OFF
7	NOT PROGRAMMED		OFF

*Timer program list*

2. Click the location in the center column of the timer program list corresponding to the timer program no. you want to set. For example, click the center column of No.2. The following timer program menu appears.

**TIMER PROGRAM No.2**

< back

ZONE: 1: NORTHWEST PACIFIC

STATION: 0: JMH/TOKYO 1

CHANNEL: AUTO

IOC: AUTO

SPEED: AUTO

START TIME: 00 00

END TIME: 00 00

FREQUENCY: 00000.0 kHz

START TIME:  ON  OFF

OK ERASE

*Timer program menu*

3. Click the arrow button on ZONE and choose desired zone.
4. Click the arrow button on STATION and choose desired station.
5. Click the arrow button on CHANNEL and choose desired channel. (Most stations transmit the same message over several frequencies, so if you are unsure of the channel choose AUTO.)
6. Click the arrow button on IOC and choose desired IOC. IOC stands Index of Cooperation and is the line density standard assigned by WMO: IOC 576, high density, IOC 288, low density. If you are unsure of the IOC, choose AUTO for automatic selection of IOC.
7. Click the arrow button on SPEED and choose desired speed. This is the drum rotating speed at the facsimile station. If you are unsure of the speed, choose AUTO for automatic selection of speed.
8. Key in the start time in 24-hour notation. Key in a start time about two minutes earlier than actual start time to allow for detection of the start signal and press the ENTER soft key.
9. Key in the end time in 24-hour notation and press the ENTER soft key. Key in an end time about two minutes later than actual end time to allow for detection of the stop signal.

**Note:** Two programs, which overlap each other, will cause the program having the later start time to be disregarded. For example, if the start and end times of program no. 1 are 01:00 and 02:00 and those of program no. 2 are 01:30 to 3:00, program no. 2 will be disregarded.

10. If necessary you may fine-tune the frequency at FREQUENCY. For a PC, enter numerical value from the keyboard.
11. Click ON below FREQUENCY.
12. Click OK.
13. Click "<back" or Back button.
14. Repeat steps 2-13 to set other timer schedule.
15. Click START.
16. Click OK.
17. Click "<back" or Back button to return to the top menu.

Then, the FAX-30 will receive facsimile broadcasts according to the timer schedule. Facsimile images are received line by line, taking 30-40 minutes to receive depending on the size of the image and drum rotation speed at the facsimile station. After a facsimile image is received it is compressed and stored in the image memory and then posted on the facsimile standby display screen. This process takes 3-5 minutes.

### **3.2.2 Turning on/off specific timer programs**

1. At the facsimile standby display, click TIMER SETUP.
2. Click PROGRAM LIST.
3. Click the center column of the program no. you want to turn on or off.
4. Click ON or OFF as appropriate.
5. Click OK.
6. Click "<back" or Back button to return to the top menu.

### **3.2.3 Clearing all timer programs**

You may clear all timer programs as follows:

1. At the facsimile standby display, click TIMER SETUP.
2. Click PROGRAM LIST.
3. Click CLEAR ALL at the top of the screen. You are asked "Are you sure to clear all?"
4. Click Ok to reset; Cancel to escape.
5. Click "<back" or Back button to return to the top menu.

### 3.3 Displaying Facsimile Images

1. Show the facsimile standby display. Thumbnails of images received are shown on the display. The equipment stores as many as 12 images, on two pages. When the image storage capacity is exceeded, the oldest image is automatically deleted to make room for the latest.

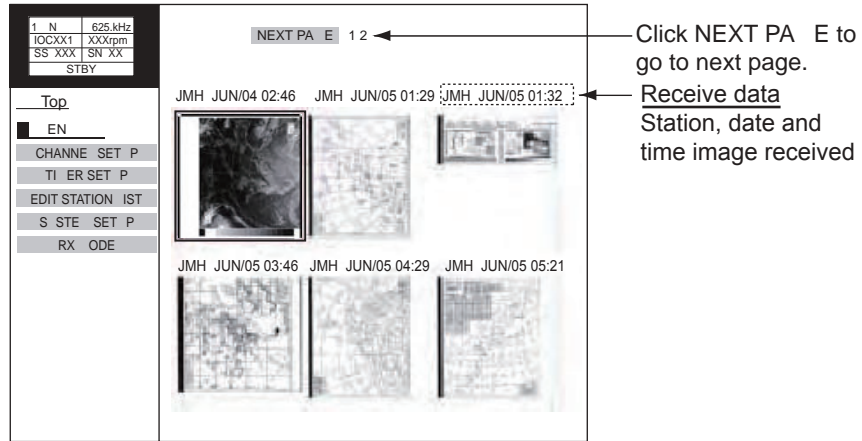

Facsimile standby display

2. Click desired image.

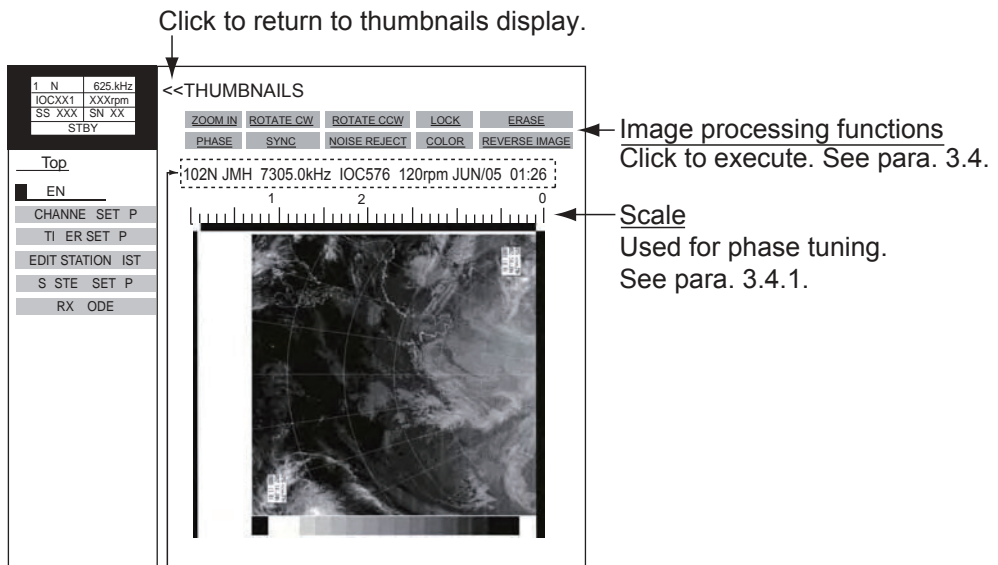

Image data  
 102N: Zone  
 JM H: Station  
 7305.0 kHz: Channel  
 IOC576: Index of Cooperation  
 120 rpm: Drum speed at fax station  
 JUN/05: Date received  
 01:26: Time received

Facsimile image

**Note:** If the FAX-30 is not accessed from the PC after it has been turned on, time data is not sent to the FAX-30. The timer recording feature may receive a facsimile image using incorrect time data, however the image may not be correctly stored.

## 3.4 Processing Facsimile Images

### 3.4.1 Phase mismatch

When the FAX-30 starts receiving a broadcast already in progress, or noise prevents detection of the phasing signal, the image may be divided into two parts by a thick black (or white) stripe called a dead sector. This phenomenon is due to phase mismatching. When this occurs, correct phase mismatching, after the facsimile has been received.

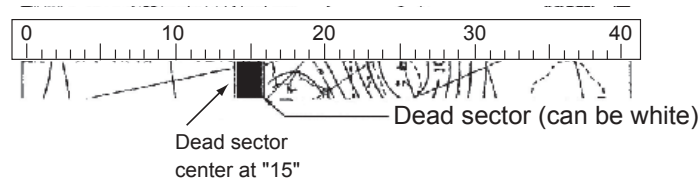

#### *Example of phase mismatching*

1. With a facsimile image displayed, click PHASE.

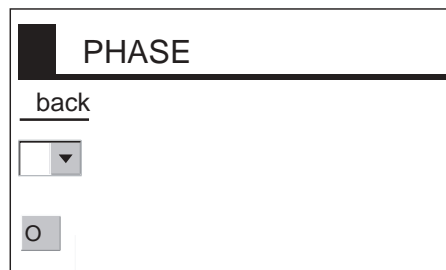

#### *Phase entry window*

2. Read the scale to find the center of the dead sector and enter it in the phase entry window. For example, if dead sector is centered at "15" on the scale, as in the illustration at the top of the page, enter "15". The setting range is 00 to 40.
3. Click OK and then click "<back" or Back button to return to the top menu.

### 3.4.2 Phasing signal out of synchronization

The SYNC soft key functions to fine-tune the phasing signal. If the dead sector is plotted at an angle even when the phase is properly selected, adjust the synchronization to display the dead sector straightly.

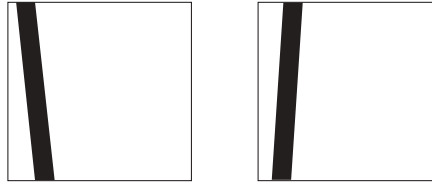

*Example of phasing signal out of synchronization*

1. With a facsimile image displayed, click SYNC.

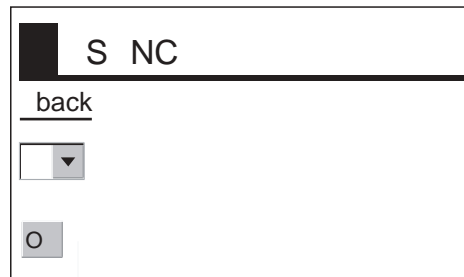

*Sync options*

2. Enter a sync value that displays the dead sector straightly and then click OK. If the dead sectors appears as in the left-hand figure above, enter a larger value and for the right-hand figure, enter a smaller value. The setting range is  $-50$  to  $+50$ .
3. Click OK and then “<back” or Back button to return to the top menu.

### 3.4.3 Noise rejection

If noise speckles appear on the image, turn on the noise rejector as below to remove the noise.

1. With a facsimile image displayed, click NOISE REJECT.

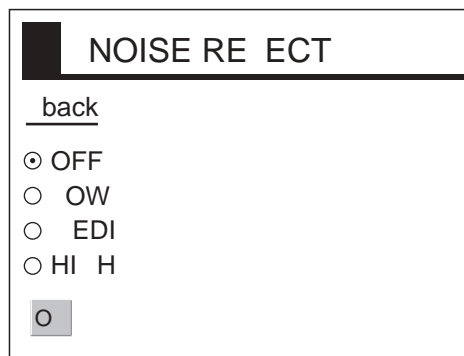

*Noise rejector options*

2. Click the noise rejection level desired and then click OK. HIGH provides the greatest degree of noise rejection.
3. Click OK and then “<back” or Back button to return to the top menu.

### 3.4.4 Image color

The facsimile image is transmitted in monochrome (black and white) or gray scale (16 gradations). After an image has been received, you can choose the color arrangement among monochrome, gray scale and color (three patterns).

1. With a facsimile image displayed, click COLOR.

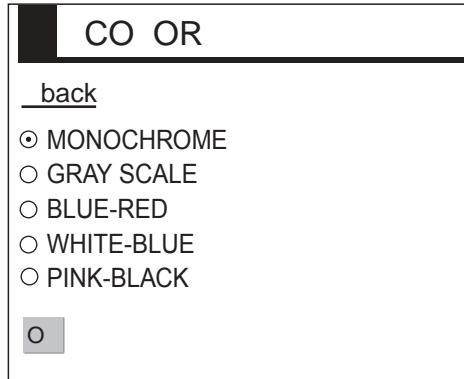

*Color options*

2. Click MONOCHROME, GRAY SCALE, BLUE-RED, WHITE-BLUE or PINK-BLACK as appropriate.  
MONOCHROME: Monochrome black and white  
GRAY SCALE: 16 gray tones (eight gray tones when power is turned off and on again)  
BLUE-RED: Shades of blue to red  
WHITE-BLUE: Shades of white to blue  
PINK-BLACK: Shades of pink to black
3. Click OK and then click "<back" or Back button to return to the top menu.

### 3.4.5 Image format

The facsimile image is usually transmitted with black text on a white background. Some stations, however, print white characters on a black background. If, for some reason, the image received cannot be read in its transmitted image format you may change it as follows:

1. With a facsimile image displayed, click REVERSE IMAGE.

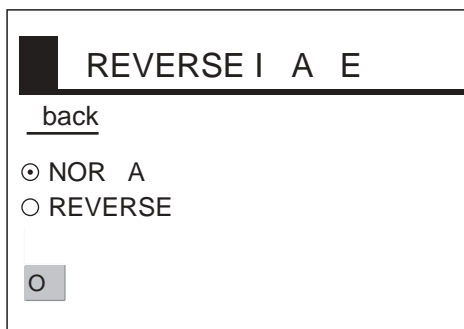

*Reverse image options*

2. Click NORMAL or REVERSE as appropriate.
3. Click OK and then click "<back" or Back button to return to the top menu.

### **3.4.6 Rotating images**

With a facsimile image displayed, click ROTATE CW or ROTATE CCW as appropriate. The image is rotated 90° in the direction selected.

### **3.4.7 Zooming images**

You may double the size of a facsimile image as follows:

1. Display the facsimile image you wish to process.
2. Click ZOOM IN.

To restore the normal size image, click ZOOM OUT.

### **3.4.8 Saving images**

You may save images to your PC for future reference.

1. At the thumbnails display, click the facsimile image you wish to save.
2. Click ZOOM IN to enlarge the image. (The image is too small if not enlarged.)
3. Place the cursor on the facsimile image and click the right button on the mouse.
4. Click the "Save Picture As..." The "Save" window appears.
5. Choose directory, enter file name and click the Save button.

## **3.5 Erasing Facsimile Images**

You may erase facsimile images as below.

1. Display the facsimile image you wish to erase.
2. Click ERASE.
3. You are asked if you are sure to erase the image. Click OK to erase the image; Cancel to escape.

## 3.6 Preventing Erasure of Facsimile Images

When facsimile image storage capacity is exceeded, the oldest facsimile image is erased to make room for the latest. If you have an image that you want to keep, you can prevent its erasure by using the “lock” feature. You can lock all images, however you may not be able to receive a new image if there is not sufficient memory remaining to store the new image.

1. Display the facsimile image you want to lock.
2. Click LOCK.

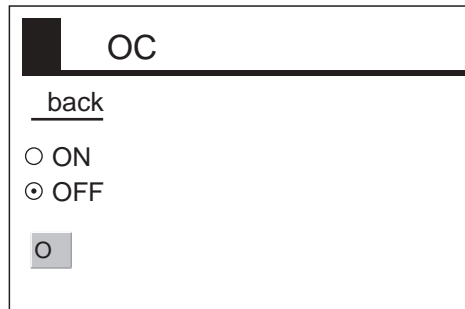

*Lock options*

3. Choose ON.
4. Click OK and then click “<back” or Back button to return to the top menu.

The locked image’s data appears in red, at the facsimile standby display. To release the lock feature for a particular image, choose OFF at the step 3 in the above procedure.

## 3.7 Adding Facsimile Channels

The FAX-30 provides a free memory for the user to store 320 channels.

1. At the standby display, click EDIT STATION LIST.

*Edit station list menu*

2. Click the arrow button on ZONE and choose desired zone.
  3. Click the arrow button on STATION and choose desired station.
  4. Click the arrow button on CHANNEL and choose desired image format.
  5. The normal facsimile image format has black text on a white background. Some stations, however, print white characters on a black background. This information is programmed into the memory thus you need not designate image format. However, if you are entering frequency data of a newly established station whose image format is reverse of the normal image, choose REVERSE.
- Note:** For a PC, enter a value at steps 6, 7 and 8 from the keyboard.
6. If necessary, you may fine-tune the frequency shown in FREQUENCY.
  7. Enter station's CALL SIGN.
  8. Enter STATION'S NAME.
  9. Click OK.
  10. Click "<back" or Back button to return to the top menu.

3. FAX OPERATION: PC

*(This page intentionally left blank.)*

# 4. NAVTEX OPERATION: NavNet and NavNet vx2

---

## 4.1 About Navtex Messages

### 4.1.1 Message categories

Navtex stations throughout the world provide mariners with weather and navigational navtex messages. These messages carry a four character header code which identifies transmitting station, category of message, and message number, numbered from 00 to 99. Message number 00 is reserved for important emergency messages. The categories of messages available in the navtex system are as below.

A: Coastal navigational warning	H: Loran message
B: Meteorological warning	I: Reserved presently not used
C: Ice report	J: Differential Omega message
D: Search and Rescue Alert	K: Other electronic navigator system message
E: Meteorological forecast	L: Navigational warning (additional)
F: Pilot message	V to Y: No category allocated
G: AIS	Z: QRU (no message on hand)

The user may select which message categories to receive and the stations from which to receive them.

**Note:** It is recommended to minimally receive categories A, B, D and L because they are important for navigation.

### 4.1.2 Receiving navtex messages

To receive navtex messages, set the receive mode for “navtex only” or “fax(timer) & navtex”, referring to paragraph 1.1.3 for the procedure.

## 4.2 Setting Up Navtex Stations, Messages, Alarms

You may freely select the navtex stations from which to receive and the messages categories to receive. Further, you may enable or disable received message alarms.

1. At the standby display, press the NAVTEX soft key. If you have received some navtex messages, their data are shown as below.

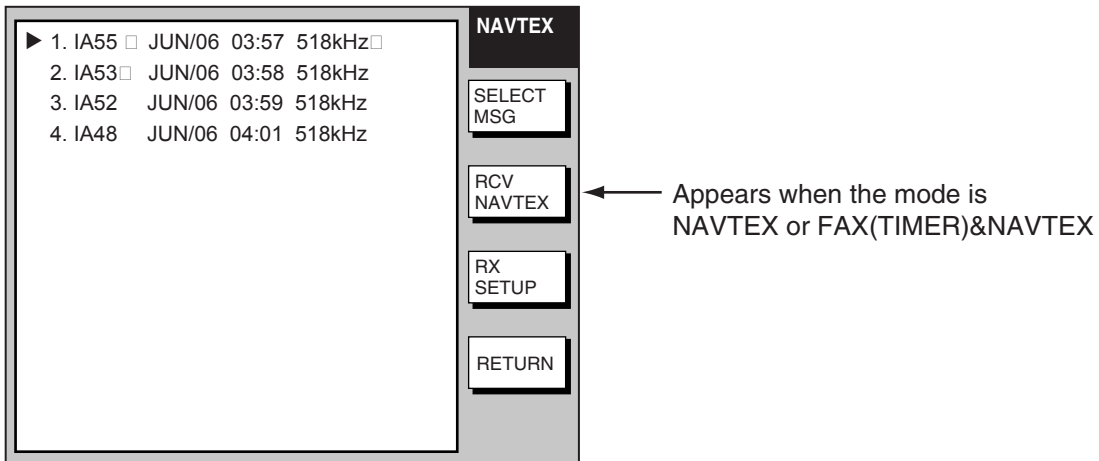

*Navtex message data display*

2. Press the RX SETUP soft key.

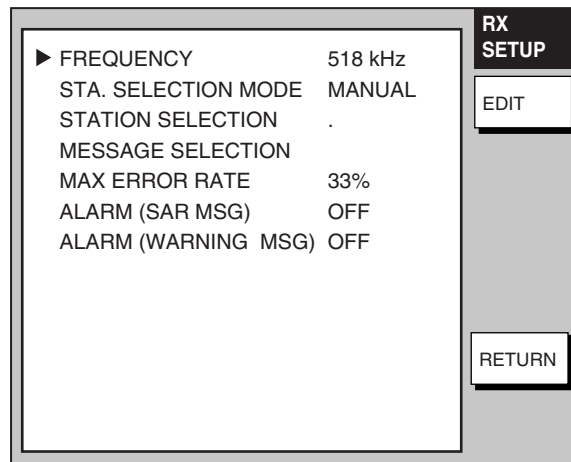

*RX setup menu*

3. FREQUENCY is selected; press the EDIT soft key.

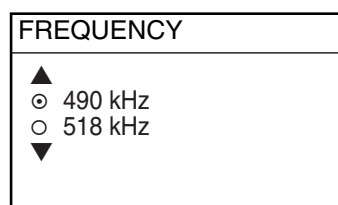

*Navtex frequency options*

4. Rotate the [ENTER] knob to choose 490 kHz or 518 kHz depending on the station and press the ENTER soft key.

- Rotate the [ENTER] knob to choose STA. SELECTION MODE and press the EDIT soft key.

STA. SELECTION MODE	
▲	
<input type="radio"/>	MANUAL
<input checked="" type="radio"/>	AUTO
▼	

*Navtex station mode options*

- Rotate the [ENTER] knob to choose navtex station selection method and press the [ENTER] soft key. AUTO requires position data, output through the network using the data sentence GGA or GLL. (See page 1-2.)
- If you selected MANUAL at step 6, rotate the [ENTER] knob to choose STATION SELECTION and press the EDIT soft key, to choose station(s) from which to receive. For AUTO, go to step 9.

STATION SELECTION	
▲	
<input checked="" type="checkbox"/>	A
<input checked="" type="checkbox"/>	B
<input checked="" type="checkbox"/>	C
<input checked="" type="checkbox"/>	D
<input checked="" type="checkbox"/>	E
<input checked="" type="checkbox"/>	F
<input checked="" type="checkbox"/>	G
<input checked="" type="checkbox"/>	H
▼	

*Navtex station options*

- Select or deselect stations as desired: Rotate [ENTER] knob to choose station and push it to select or deselect. Check mark indicates station is selected; no check mark means deselected.
- Press the ENTER soft key to return the RX SETUP menu.
- Rotate the [ENTER] knob to choose MESSAGE SELECTION and press the EDIT soft key.

MESSAGE SELECTION	
▲	
<input checked="" type="checkbox"/>	A NAVIGATIONAL WARNING
<input checked="" type="checkbox"/>	B METEOR. WARNING
<input checked="" type="checkbox"/>	C ICE REPORT
<input checked="" type="checkbox"/>	D SAR INFORMATION
<input checked="" type="checkbox"/>	E METEOR. FORECAST
<input checked="" type="checkbox"/>	F PILOT MESSAGE
<input checked="" type="checkbox"/>	G DECCA MESSAGE
<input checked="" type="checkbox"/>	H LORAN MESSAGE
▼	

*Navtex message options*

- Select or deselect message categories as desired: Rotate [ENTER] knob to choose message category and push it to select or deselect. Check mark indicates message is selected; no check mark means deselected.
- Press the ENTER soft key.
- Rotate the [ENTER] knob to choose MAX ERROR RATE and press the EDIT soft key.

#### 4. NAVTEX OPERATION: NAVNET

MAX ERROR RATE
33%

*Max error rate entry window*

14. Rotate the [ENTER] knob to enter maximum allowable error rate to use. The setting range is 0-33%. Any message with an error rate higher than that entered here will be rejected.
15. Press the ENTER soft key.
16. Rotate the [ENTER] knob to choose ALARM (SAR MSG) and press the EDIT soft key.

ALARM (SAR MSG)
▲ <input type="radio"/> ON <input checked="" type="radio"/> OFF ▼

*Alarm (SAR MSG) options*

17. Rotate the [ENTER] knob to choose ON to get the audio alarm when an SAR (Search and Rescue) message is received, or OFF for no audio alarm when an SAR message is received.

**Note:** Message category D must be selected to get the audio alarm.

18. Press the ENTER soft key.
19. Rotate the [ENTER] knob to choose ALARM (WARNING MSG) and press the EDIT soft key.

ALARM (WARNING MSG)
▲ <input type="radio"/> ON <input checked="" type="radio"/> OFF ▼

*Alarm (warning msg) options*

20. Rotate the [ENTER] knob to choose ON to get the audio alarm when an A, B, or L category message is received, or choose OFF for no audio alarm.

**Note:** Message category A, B or L must be selected to get the audio alarm.

21. Press the [RETURN] soft key.

**Note:** When the above alarms are enabled, the audio alarm sounds and the speaker icon (🔊) appears when an SAR message or category A, B, D or L message is received. Press the [CLEAR] key to silence the audio alarm. You can see which type of message you have received by pressing the [ALARM] key to display the alarm message board.

## 4.3 Previewing Incoming Navtex Messages

If you want to view a navtex message while it is being received, do the following:

1. At the standby display, press the NAVTEX soft key. If no messages have been received the display shows "NO RECEIVED MESSAGES AVAILABLE."

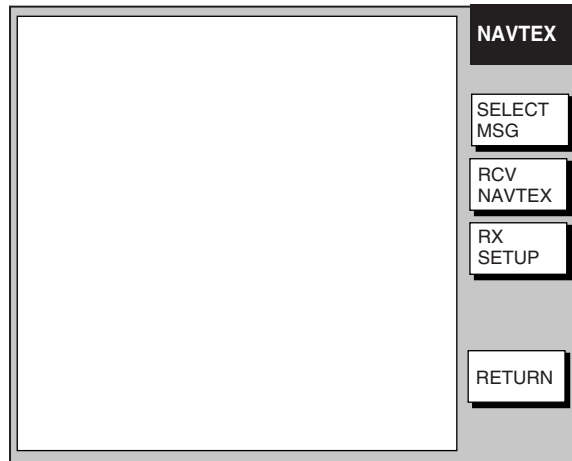

*Navtex message selection screen*

2. Press the RCV NAVTEX soft key.

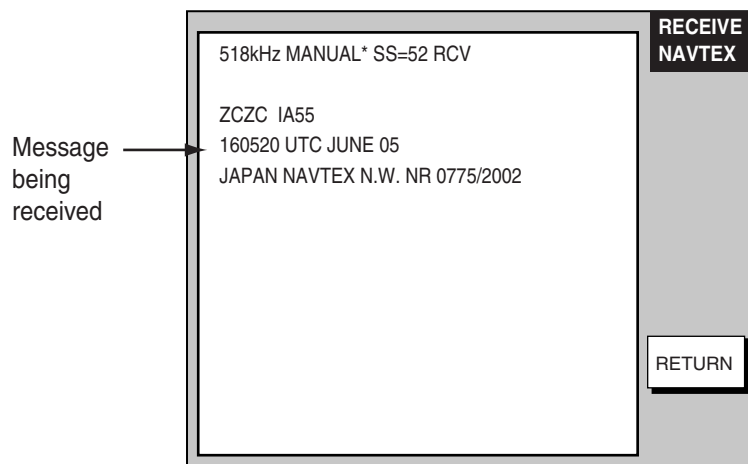

\* = "AUTO LAT/LON" and OK or NG (No Good) shown in automatic reception.

*Navtex message preview display*

3. Press the RETURN soft key several times to return to standby display.

## 4.4 Displaying Navtex Messages

### 4.4.1 Displaying navtex messages

1. At the standby display, press the NAVTEX soft key.

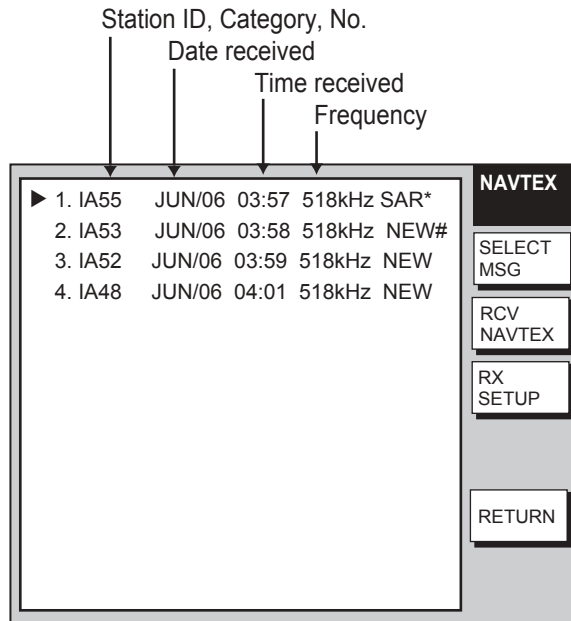

\* = "SAR" denotes SAR message.

# = NEW means unread message, and it disappears when the power is turned off.

#### *Navtex message selection screen*

2. Rotate the [ENTER] knob to choose the message to display.
3. Press the SELECT MSG soft key or push the [ENTER] knob.

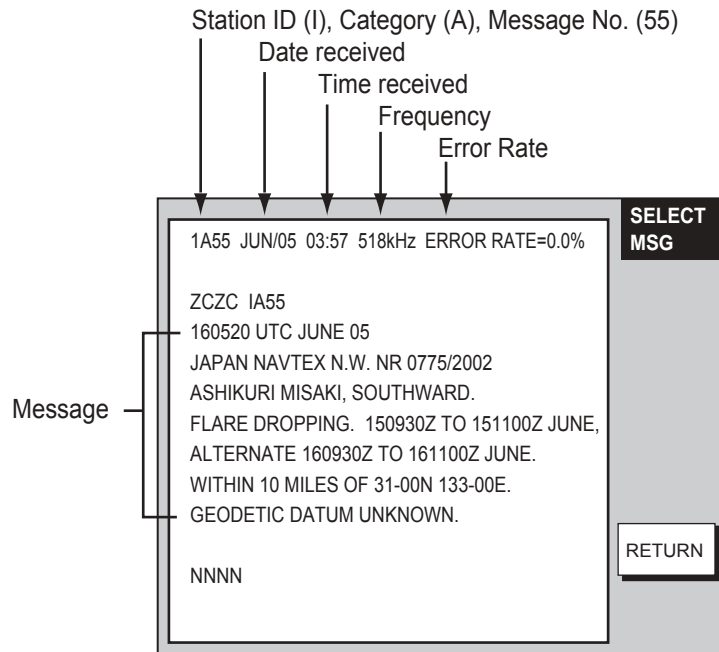

#### *Sample navtex message*

4. Press the RETURN soft key several times to return to the standby display.

#### 4.4.2 Remarks on navtex messages

- All navtex messages begin with “ZCZC” (navtex message ID) and end with “NNNN”. Immediately following ZCZC, the transmitting station ID, message category and message number are shown. In the example illustration at the bottom of the previous page this data is “IA55.”

I = Transmitting station's ID

A = Message category

55 = Message number

- An asterisk (\*) is displayed in place of actual character when the character could not be read.
- Message number 00 contains important emergency information.
- The FAX-30 holds 130 navtex messages. When the navtex message storage capacity is exceeded, the oldest navtex message is automatically deleted to make room for the latest.

## 4.5 Displaying the Navtex Station List

You may display the navtex stations stored in the FAX-30, as follows:

1. Press the [MENU] key to open the FAX-30 menu.
2. Press the EDIT NAVTEX STATION soft key.
3. Press the 490 kHz STATION LIST soft key or the 518 kHz STATION LIST soft key as appropriate. The illustration below shows the nav areas for 490 kHz.

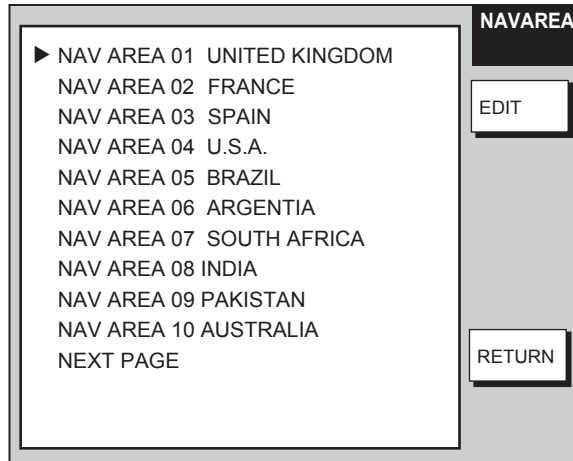

*Nav areas for 490 kHz navtex stations*

4. Choose nav area desired and push the [ENTER] knob. For example, choose nav area 01 of 490 kHz to show the 490 kHz station list.  
(To choose nav area 11 to 16, choose NEXT PAGE and push the [ENTER] knob.)

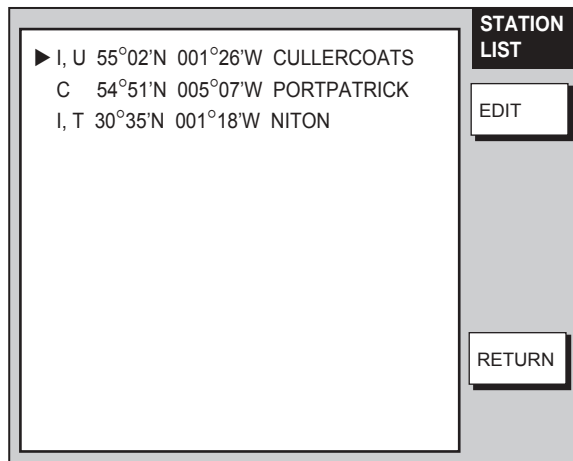

*490 kHz stations of nav area 1*

5. If you want to view or edit the contents of a navtex station, rotate the [ENTER] knob to choose a station and press EDIT soft key. Follow the instructions in the previous paragraph to edit a station.
6. Press the [MENU] key to return to the standby screen.

## 4.6 Adding Navtex Stations

You may add newly established navtex stations to the navtex station list as follows:

1. Press the [MENU] key to open the FAX-30 menu.
2. Press the EDIT NAVTEX STATION soft key.

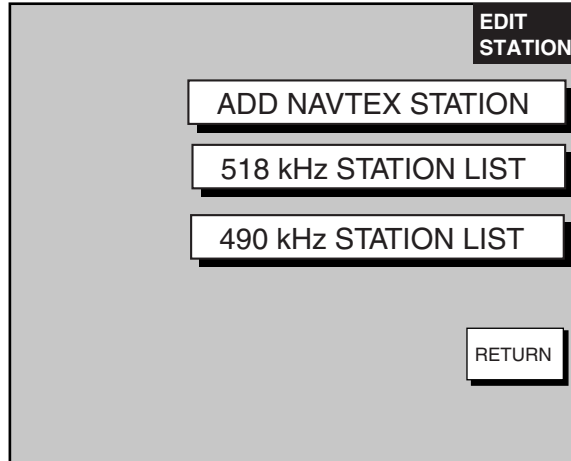

*Edit station menu*

3. Press the ADD NAVTEX STATION soft key.

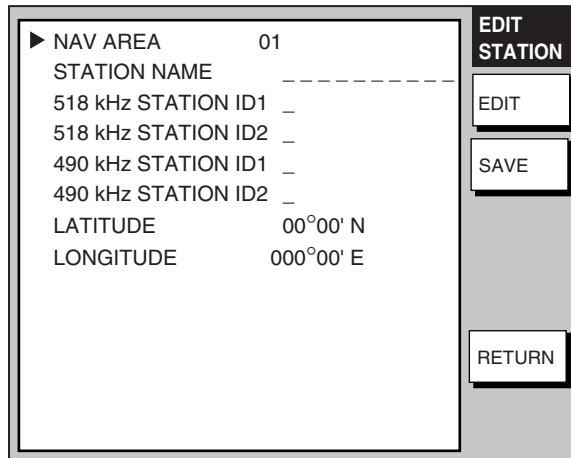

*Edit navtex station menu*

4. NAV AREA is selected; press the EDIT soft key.

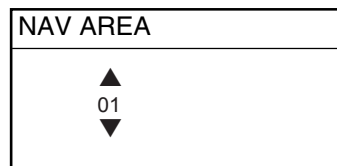

*Nav area selection window*

5. Choose appropriate area, referring to the navtex station map in the Appendix, and press the ENTER soft key.

#### 4. NAVTEX OPERATION: NAVNET

6. Rotate the [ENTER] knob to choose STATION NAME and press the EDIT soft key.

STATION NAME
█-----

*Station name entry window*

7. Enter station name with the alphanumeric keys and trackball and then press the ENTER soft key.
8. Rotate the [ENTER] knob to choose 518 STATION ID1 or 490 STATION ID1 as appropriate and press the EDIT soft key.

518 kHz STATION ID1
█

*Station ID1 entry window*

9. Enter station ID (A-Z) and press the ENTER soft key.
10. If there are multiple stations, enter station ID in 518 kHz STATION ID2 or 490 kHz STATION ID2 as appropriate.
11. Rotate the [ENTER] knob to choose LATITUDE and press the EDIT soft key.

LATITUDE
00°00' N

*Latitude entry window*

12. Enter the latitude of the station and press the ENTER soft key. Use the [N↔S] soft key to switch from North latitude to South latitude and vice versa.
13. Rotate the [ENTER] knob to choose LONGITUDE and press the EDIT soft key. Enter longitude of the station similar to how you entered latitude. Use the [W↔E] soft key to switch from West longitude to East longitude and vice versa.
14. Press the SAVE soft key.
15. Rotate the [ENTER] knob to choose YES and then push the [ENTER] knob.
16. Press the [MENU] key to close the menu.

# 5. NAVTEX OPERATION: NavNet 3D, PC

---

## 5.1 About Navtex Messages

### 5.1.1 Message categories

Navtex stations throughout the world provide mariners with weather and navigational navtex messages. These messages carry a four character header code which identifies transmitting station, category of message, and message number, numbered from 00 to 99. Message number 00 is reserved for important emergency messages. The categories of messages available in the navtex system are as below.

A: Coastal navigational warning	H: Loran message
B: Meteorological warning	I: Reserved presently not used
C: Ice report	J: Differential Omega message
D: Search and Rescue Alert	K: Other electronic navigator system message
E: Meteorological forecast	L: Navigational warning (additional)
F: Pilot message	V to Y: No category allocated
G: AIS	Z: QRU (no message on hand)

The user may select which message categories to receive and the stations from which to receive them.

**Note 1:** It is recommended to minimally receive categories A, B, D and L because they are important for navigation.

**Note 2:** To learn more about navtex messages, see paragraph 4.4.2.

### 5.1.2 Receiving navtex messages

To receive navtex messages, set the receive mode for “navtex only” or “fax & navtex”, referring to paragraph 1.2.2 for the procedure.

## 5.2 Setting Up Navtex Stations, Messages

You may freely select the navtex stations from which to receive and the messages categories to receive as follows:

1. At the navtex top menu, click RX SETUP.

**RX SETUP**

[< back](#)

FREQUENCY

STATION SELECTION MODE

STATION ID SELECTION

A B C D  
E F G H  
I J K L  
M N O P  
Q R S T  
U V W X  
Y Z

490 kHz STATION LIST

518 kHz STATION LIST

MESSAGE ID SELECTION

A B C D  
E F G H  
I J K L  
M N O P  
Q R S T  
U V W X  
Y Z

MESSAGE LIST

MAX. ERROR RATE (0-  %  
33%)

OK

*RX setup menu*

2. Click the arrow button on FREQUENCY and choose desired frequency.
3. Click the arrow button on STATION SELECTION MODE and choose desired mode, AUTO or MANUAL.

AUTO requires connection to the NavNet network and is not available in the PC-only configuration. The FAX-30 requires position data (data sentence GGA or GLL) and time data (data sentence ZDA), fed through the NavNet network.

4. Click desired stations in STATION ID SELECTION. Check mark indicates item is selected. (If you need help with station selection, click 490 kHz STATION LIST or 518 kHz STATION LIST for details.)
5. Click desired messages in MESSAGE ID SELECTION. Check mark indicates item is selected. (If you need help with message selection, click MESSAGE LIST for details.)
6. At MAX. ERROR RATE, enter the maximum allowable error rate to use. The setting range is 0-33 (%). Any message with an error rate higher than entered here will be rejected. For a PC, enter numerical value from keyboard.
7. Click OK and then click "<back" or Back button to return to the top menu.

## 5.3 Displaying Navtex Messages

At the navtex standby display, click the desired message number at the top of the display.

Received messages (click to display)

The screenshot shows a Navtex standby display with the following components:

- Top Left:** A small menu with options: 518kHz, AUTO LAT/LON OK, SS=10, STBY.
- Top Center:** A list of received messages:
  1. 1A55 06/22 00:26 518kHz
  2. 1A55 06/20 01:22 518kHz
  3. 1A55 06/18 15:31 518kHz
  4. 1A55 06/17 07:11 518kHz
  5. 1A55 06/15 03:44 518kHz
- Top Right:** A scroll bar with the text "NEXT PAGE 1/2" above it. An arrow points to it with the text "Use scroll bar to scroll list."
- Left Side:** A "MENU" section with options: << Top, RX SETUP, EDIT STATION LIST, SYSTEM SETUP, RX MODE.
- Center:** A "PREV" and "NEXT" button above a dashed box containing the selected message data: "1A55 05/30 03:57 518kHz ERROR RATE=0.0%". An arrow points to this box with the text "Navtex message data".
- Right Side:** A legend for the message data:
  - IA55: Station ID (I), Category (A), Message No. (55)
  - 05/30: Date received
  - 03:57: Time received
  - 518kHz: Frequency
  - Error rate
- Bottom:** The text of the message: "ZCZC IA55 160520 UTC JUNE 05 JAPAN NAVTEX N.W. NR 0775/2002 ASHIKURI MISAKI, SOUTHWARD. FLARE DROPPING. 150930Z TO 151100Z JUNE, ALTERNATE 160930Z TO 161100Z JUNE. WITHIN 10 MILES OF 31-00N 133-00E. GEODETIC DATUM UNKNOWN. NNNN". An arrow points to this text with the text "Text of message".

*Navtex standby display*

## 5.4 Displaying the Navtex Station List

You may display the navtex stations stored in the FAX-30 as follows:

1. At the navtex top menu, click EDIT STATION LIST.
2. Click 490 kHz STATION LIST or 518 kHz STATION LIST as appropriate. The illustration below shows the 490 kHz list.

490kHz STATION LIST

NAVAREA  ▼

STATION LIST
I, U 55° 02'N 001° 26'W CULLERCOATS
S 54° 51'N 005° 07'W PORTPATRICK
I, T 50° 35'N 001° 18'W NITON

*Navtex station list*

3. Pull down the arrow button on NAVAREA to choose nav area desired.

## 5.5 Adding Navtex Stations

You may add newly established navtex stations to the navtex station list as follows:

1. At the navtex standby display, click EDIT STATION LIST.

**EDIT STATION LIST**

back

NAVAREA  ▼

STATION NAME

518kHz STATION ID1

518kHz STATION ID2

9 kHz STATION ID1

9 kHz STATION ID2

ATIT DE   N ▼

ON IT DE   E ▼

ADD CANCEL

9 kHz STATION LIST

518 kHz STATION LIST

*Edit station list*

2. Click the arrow button on NAVAREA and choose desired navarea.
3. From a PC, enter the station name in STATION NAME.
4. From a PC, enter station ID (A-Z) in STATION ID1 (and STATION ID2 if it has two IDs).
5. Enter latitude and longitude position of station.
6. Click ADD to register data entered.
7. To register another station, click NEW and repeat steps 2-6.
8. Click "<back" or Back button to return to the navtex top menu.

## 5.6 Editing Navtex Stations

You may edit navtex stations as follows:

1. At the navtex standby display, click EDIT STATION LIST.
2. Click 490 kHz STATION LIST or 518 kHz STATION LIST, whichever you want to process. For example, click 490 kHz STATION LIST.
3. Click the arrow button on NAVAREA and choose desired navarea. For example, choose UNITED KINGDOM.
4. In the station list, click the station to process. For example, click CULLERCOATS.

5
EDIT STATION LIST

back

NAVAREA

STATION NAME

518kHz STATION ID1

518kHz STATION ID2

9 kHz STATION ID1

9 kHz STATION ID2

ATITUDE

POSITION

SAVE CANCEL ERASE

NEW

9 kHz STATION LIST

518 kHz STATION LIST

If you want to register a new station from this screen, click NEW. The screen shown on page 5 5 appears. Follow the procedure on page 5 5.

### *Edit station list*

5. Edit the data.
6. Click SAVE to save data.
7. Click "<back" or Back button to return to the navtex top menu.

## 5.7 Deleting Navtex Stations

You may delete navtex stations from the navtex station list as below.

1. At the navtex standby display, click EDIT STATION LIST.
2. Click 490 kHz STATION LIST or 518 kHz STATION LIST, whichever you want to process.
3. Click the arrow button on NAVAREA and choose desired navarea.
4. In the station list, click the station to process.
5. Click ERASE.
6. Click OK to erase the station, or the Cancel button to escape.
7. Click "<back" or Back button to return to the navtex top menu.

5. NAVTEX OPERATION: PC

*(This page intentionally left blank.)*

# 6. MAINTENANCE, TROUBLESHOOTING

---

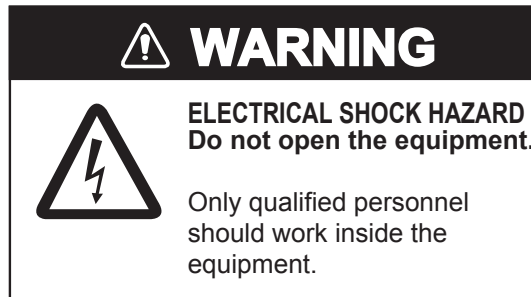

## 6.1 Maintenance

This unit is designed and manufactured to provide many years of trouble-free performance. However, no machine can perform to the utmost of its ability unless properly maintained. A maintenance program should be established and it should include the items listed in the table below.

### Maintenance points

Check Point	Action
Whip antenna	Check for damage. Replace if damaged.
Antenna wire	Check for damage. Replace if damaged.
Junction between whip antenna and preamp (option)	Check for corrosion and tight connection. Clean and waterproof with sealing compound if necessary.
Coaxial cable	Check for damage and tight connection. Replace if damaged.
Power cable	Check for tight connection at battery and FAX-30.
Ground terminal	Check for tight connection and corrosion. Replace if corroded.
Unit cleanliness	Dust and dirt should be removed with a soft cloth. Do not use solvents such as benzine and toluene to clean the unit – they can remove paint and markings or deform the equipment.

## 6.2 Replacement of Fuse

The 2A fuse in the power cable protects the equipment from equipment fault and reverse polarity of the ship's mains. If the fuse blows find the cause before replacing it. If it blows again after replacement, contact your dealer for advice.

 <b>CAUTION</b>
<b>Use the proper fuse.</b>
Use of a wrong fuse may cause <input type="checkbox"/> serious damage to the equipment <input type="checkbox"/> and void the warranty.

## 6.3 Troubleshooting

This section provides simple troubleshooting that the user may follow to restore normal operation.

### Troubleshooting

<b>Trouble</b>	<b>Problem</b>	<b>Remedy</b>
NavNet display unit freezes	<ul style="list-style-type: none"> <li>• Jumbled memory</li> </ul>	<ul style="list-style-type: none"> <li>• Turn the NavNet display unit off and on again.</li> </ul>
Command from NavNet display unit not accepted	<ul style="list-style-type: none"> <li>• Network not connected</li> </ul>	<ul style="list-style-type: none"> <li>• Reselect the FAX mode.</li> </ul>
Cannot read characters	<ul style="list-style-type: none"> <li>• Corrupted memory</li> </ul>	<ul style="list-style-type: none"> <li>• Clear memory.</li> </ul>
Noise but no signal	<ul style="list-style-type: none"> <li>• Loosened antenna connector</li> <li>• Coaxial cable in antenna cable is shorted or damaged.</li> </ul>	<ul style="list-style-type: none"> <li>• Fasten antenna connector.</li> <li>• Replace antenna cable.</li> </ul>
Multiple or overlapped image	<ul style="list-style-type: none"> <li>• Wrong speed setting</li> </ul>	<ul style="list-style-type: none"> <li>• Set correct speed. Speed may be adjusted when manually receiving an image.</li> </ul>
Image is split.	<ul style="list-style-type: none"> <li>• Image is out of phase.</li> </ul>	<ul style="list-style-type: none"> <li>• Set phase manually.</li> </ul>
Image is shrunk (or enlarged) vertically.	<ul style="list-style-type: none"> <li>• Wrong IOC</li> </ul>	<ul style="list-style-type: none"> <li>• Change IOC. IOC may be adjusted when manually receiving an image.</li> </ul>
Image is filled with noise.	<ul style="list-style-type: none"> <li>• Noise</li> </ul>	<ul style="list-style-type: none"> <li>• Use the noise rejector to remove noise.</li> </ul>
Timer schedule does not start as scheduled.	<ul style="list-style-type: none"> <li>• Improper setting of schedule</li> </ul>	<ul style="list-style-type: none"> <li>• Review schedule.</li> </ul>
Cannot access FAX-30 from PC.	<ul style="list-style-type: none"> <li>• Incorrect IP address or subnet mask set on PC.</li> </ul>	<ul style="list-style-type: none"> <li>• Check setting referring to page 7-8.</li> </ul>

## 6.4 Diagnostics

### 6.4.1 NavNet

The diagnostics test displays program no. and tests the ROMs, RAM, receive ability, signal strength, signal-to-noise ratio and position data. The test results are displayed as OK or NG (No Good) for ROM, RAM, receive ability and position data. For any NG or abnormal value, contact your dealer for advice.

1. Press the [MENU] key to show the FAX-30 menu.

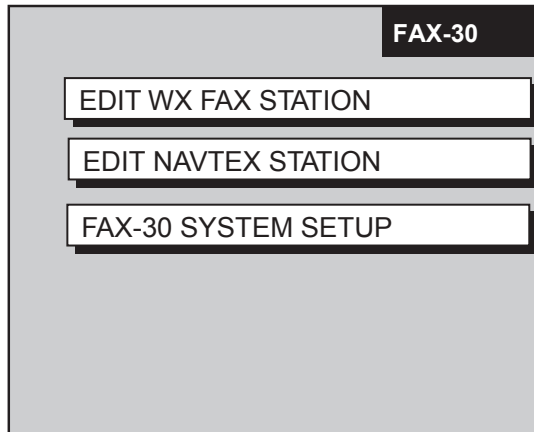

*FAX-30 menu*

2. Press the FAX-30 SYSTEM SETUP soft key.

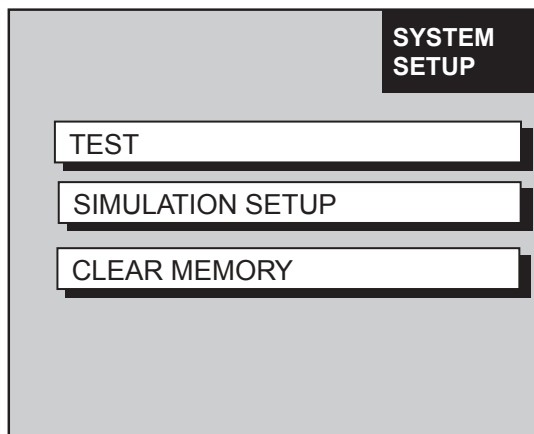

*System setup menu*

- Press the TEST soft key to start the test. The test results appear as shown below.

Asterisk marks item currently being tested

PROGRAM NO.	0850188-XX		
	0850189-XX		
* ROM1	: OK		
ROM2	: OK		
SDRAM	: OK		
RECEIVE UNLOCK	: OK		
SS*1	: 60		
SN*2	: 60		
LAT/LON*3	: OK		

TEST

RETURN

XX = Version no.

\*1 SS = Signal Strength  
Display Range: 0-99  
Typical Reading: 30-70

\*2 SN = Signal-to-Noise Ratio  
Display Range: 0-99  
Typical Reading: 20-60

\*3 Requires data sentence GGA or GLL, output through the network.

- Press the RETURN key to escape from the test.

### 6.4.2 NavNet 3D, PC

The diagnostics test displays program no. And tests the ROMs and RAM, receive ability and position data. The test results are displayed as OK or NG (No Good). For any NG or abnormal value, contact your dealer for advice.

- At the facsimile or navtex standby display, click FAX-30 SYSTEM SETUP.
- Click TEST. The test results appear as shown below.

<b>PROGRAM NO.</b>	0850188-XX 0850189-XX
<b>ROM1</b>	OK
<b>ROM2</b>	OK
<b>SDRAM</b>	OK
<b>RECEIVE UNLOCK</b>	OK
<b>LAT/LON*</b>	OK

XX = Program Version No.

\* = Requires data sentence GGA or GLL.

*Diagnostic test results*

- Click STOP TEST to stop the test and restore normal operation and enable receiving.
- Click "<back" or Back button several times to return to the top menu.

## 6.5 Clearing Data

### 6.5.1 NavNet

You may clear all facsimile images, navtex messages and the entire memory contents to start afresh.

1. Press the [MENU] key to open the FAX-30 menu.
2. Press the FAX-30 SYSTEM SETUP soft key.
3. Press the CLEAR MEMORY soft key.

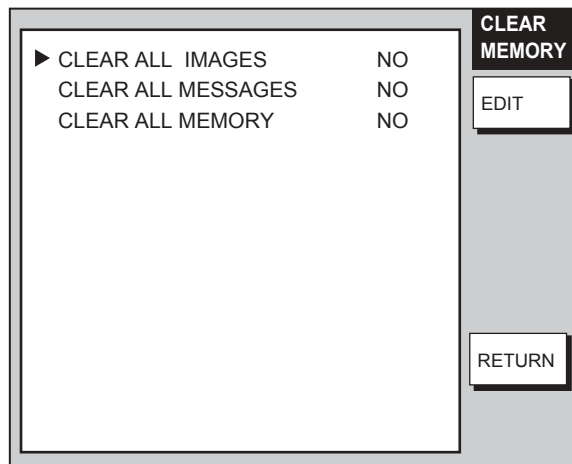

*Clear memory menu*

4. Rotate the [ENTER] knob to choose the item you wish to clear and press the EDIT soft key. (Clearing all memories erases all fax images, navtex messages and all setting data (for example, user-set stations)).

For example, choose CLEAR ALL IMAGES and press the EDIT soft key to clear all facsimile images.

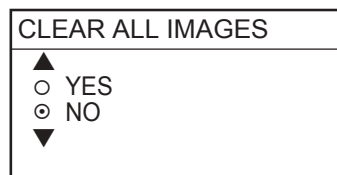

*Clear all images options*

5. Rotate the [ENTER] knob to choose YES and push the [ENTER] knob.
6. Press the RETURN soft key to close the menu and return to the standby display.

## 6.5.2 NavNet 3D, PC

You may clear all facsimile images, navtex messages and the entire memory contents to start afresh.

1. At the facsimile or navtex standby display, click SYSTEM SETUP.
2. Click CLEAR MEMORY.

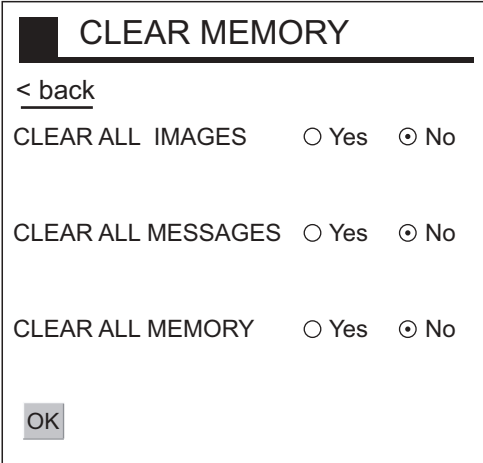

**CLEAR MEMORY**

< back

CLEAR ALL IMAGES     Yes     No

CLEAR ALL MESSAGES     Yes     No

CLEAR ALL MEMORY     Yes     No

OK

*Clear memory options*

3. Click Yes for the memory(s) to clear.  
**Note:** Clearing all memories erases all fax images, navtex messages and all setting data (for example, user-set stations).
4. Click OK.
5. You are asked if you are sure to clear the memory(s) selected. Click OK to clear; Cancel to escape.
6. Click “<back” or Back button several times to return to the top menu.

## 6.6 All Clear (for technicians)

If the FAX-30 cannot be operated from a NavNet/NavNet 3D display unit or a PC, the reason can be stray data. Do the procedure shown below to clear the stray data and restore normal operation.

1. Turn off the FAX-30.
2. Open the cover of the FAX-30.

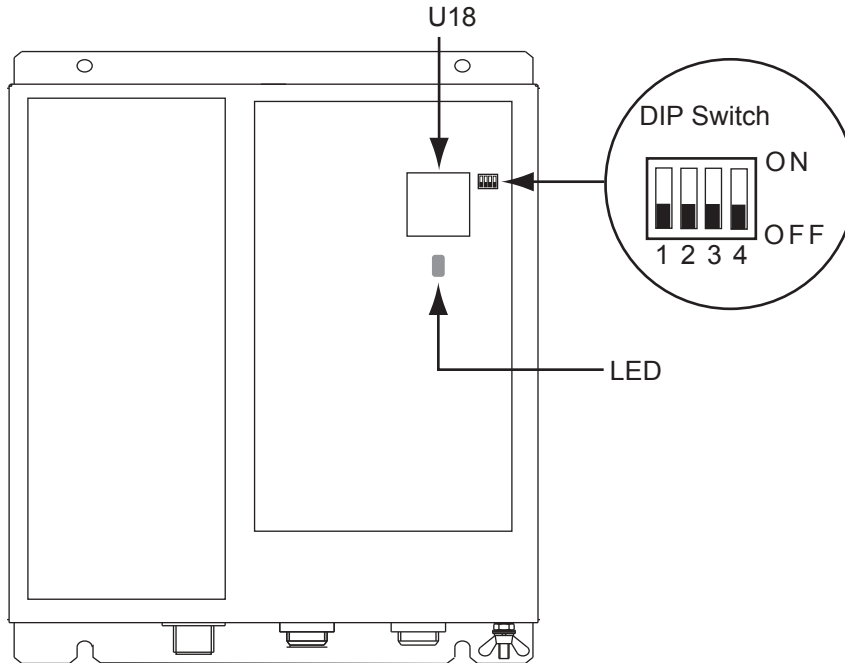

3. Turn ON the #1 segment of the DIP switch and then turn on the FAX-30. The LED below U18 blinks slowly when default settings have been restored. It takes about one minute to restore the settings.
4. Turn off the FAX-30. Turn off all segments of the DIP switch. (All segments must be turned off, otherwise all clear will be executed at start up.)
5. Turn on the FAX-30 and connect it to the PC that has IP address 172.31.x.x.
6. Open Internet Explorer at the PC and enter the URL <http://172.31.8.1>. Confirm that the "TOP" display appears.
7. Turn off the FAX-30 and close its cover.

## 6.7 Simulation Mode

The simulation mode provides simulated operation of the equipment, using an internally generated fax image and navtex message. The fax image may be processed as desired. This mode is mainly used for exhibition purposes.

**Note:** All current fax images and navtex messages will be erased when activating the simulation mode.

### 6.7.1 NavNet

1. At the facsimile standby display, press the [MENU] key.
2. Press the FAX-30 SYSTEM SETUP soft key.
3. Press the SIMULATION SETUP soft key.

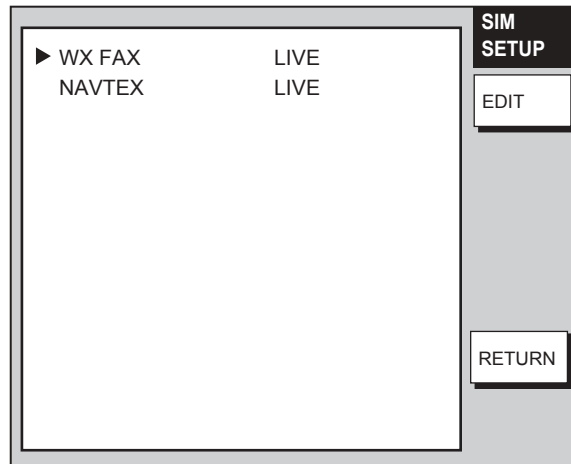

*Simulation setup menu*

4. Choose WX FAX or NAVTEX as appropriate and press the EDIT soft key. The illustration below shows the dialog box for WX FAX; the dialog box for NAVTEX is similar.

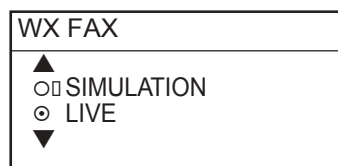

5. Rotate the [ENTER] knob to choose SIMULATION and press the ENTER soft key.

The fax image and navtex message will then be posted to the respective standby display.

## 6.7.2 Navnet 3D, PC

1. At the facsimile or navtex standby display, click SYSTEM SETUP.
2. Click SIMULATION SETUP.

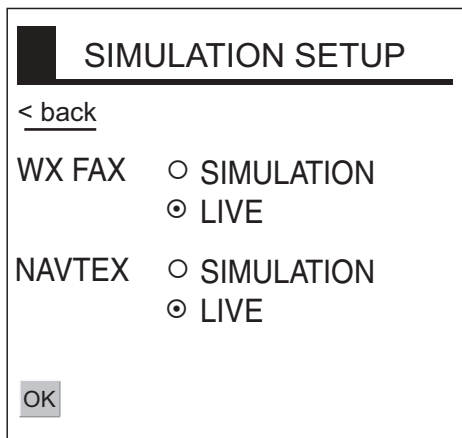

### *Simulation setup menu*

3. Choose SIMULATION for WX FAX and/or NAVTEX as appropriate.
4. Click OK.
5. Click "<back" or Back button to return to the top.

The fax image and navtex message will then be posted to respective standby display.

6. MAINTENANCE, TROUBLESHOOTING

*(This page intentionally left blank.)*

# 7. INSTALLATION

## 7.1 Facsimile Receiver

The facsimile receiver may be mounted on the deck or a bulkhead. When selecting a mounting location, keep in mind the following points:

- Locate the unit out of direct sunlight because of heat that can build up inside the cabinet.
- Select a location where the connectors can be easily accessed.
- Leave sufficient space around the unit for servicing and maintenance. See the outline drawing for recommended servicing space.
- For mounting on a bulkhead, be sure the mounting location is strong enough to support the weight of the unit.
- Locate the unit away from areas subject to water splash and rain.
- A magnetic compass will be disturbed if the FAX-30 is placed too close to it. Separate the FAX-30 from a magnetic compass by the distances below to prevent interference to a magnetic compass.

Steering compass, 0.9 m, Standard compass, 0.6 m.

- Fix the receiver to the mounting location with four 5 X 20 tapping screws (supplied).

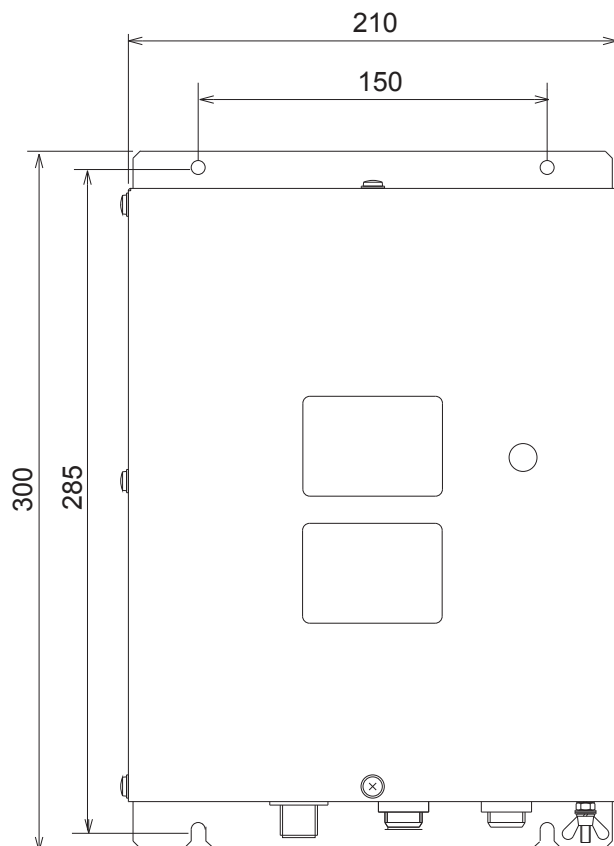

*Mounting dimensions of facsimile receiver FAX-30*

## 7.2 Antenna Unit

The performance of the facsimile receiver is directly related to the antenna installation. In general, the antenna should be installed as high as possible on the vessel, free from the influence of nearby antennas, rigging and masts. Be sure to locate the antenna well away from TX antennas and noise generating equipment. Pay particular attention to the antennas of MF and HF radio equipment - they can damage the facsimile receiver through induction. (For better protection against induction, use the preamp unit.)

### 7.2.1 General antenna connection

Connect the antenna to the facsimile receiver as shown below. If the preamp unit is installed, set jumper block J23 on the RCV Board (in the FAX-30) to the "ACTIVE" position. See paragraph 7.4.

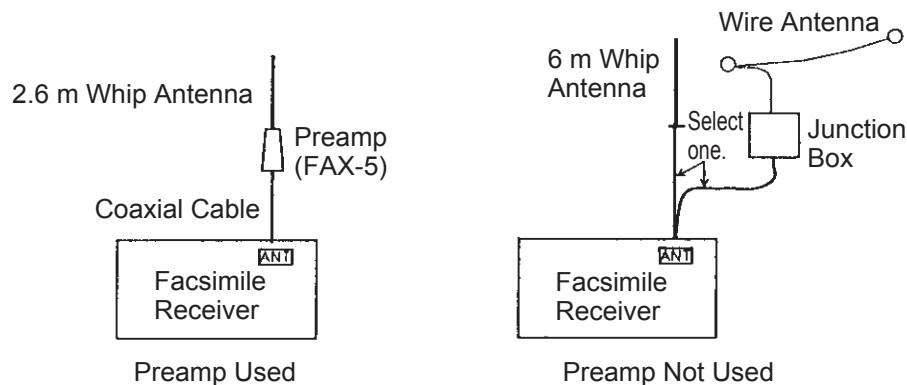

*Antenna wiring and preamp status*

### 7.2.2 Wire antenna or whip antenna

- Either a long wire or whip antenna may be used. A wire antenna should be 15 meters or longer including the vertical section. A whip antenna should be 6 meters long.
- The antenna can be shared with other receivers; use an antenna switch or junction box.
- Connect the antenna to the facsimile receiver with a coaxial cable of which the diameter is larger than coaxial cable type 5D-2V. (5D-2V is a JIS (Japan Industry Standard) Cable. Use equivalent cable, referring to the table in paragraph 7.3.
- If sensitivity of the wire antenna is low, use the preamp unit.

### 7.2.3 Installation of preamp unit FAX-5 (option)

Small boats may not afford the space to install a long wire antenna. In this case it is recommended to install the preamp unit with 2.6 meter whip antenna. The preamp unit can be installed two ways:

- The base of the preamp unit is designed to accept a threaded extension of one-inch diameter. The pitch of the thread should be 14 threads per inch. The mast itself should be no longer than 1.5 meters to prevent flexing in heavy winds.
  - Attach the preamp unit to a post with stainless steel hose clamps (option).
1. Fix the preamp unit to the mounting location.
  2. Screw the whip antenna onto the preamp unit.
  3. If the mast is metallic, run a ground wire (local supply) between the mast and the ground terminal on the preamp unit.
  4. Waterproof the junction and other exposed metallic parts with silicone sealant.

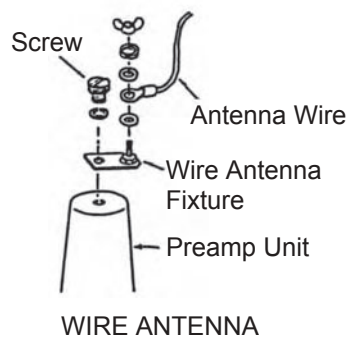
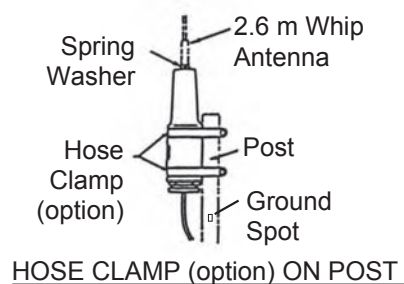
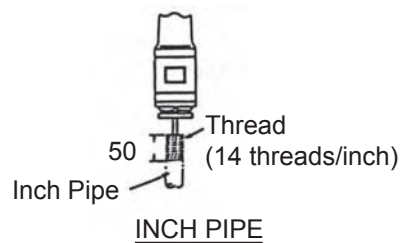

#### *How to mount the preamp unit FAX-5*

**Note 1:** An antenna wire several meters in length can be connected instead of the whip antenna. In this case, install the wire antenna fixture (supplied with preamp unit) between the antenna wire and the preamp unit as illustrated above.

**Note 2:** The preamp unit is powered by the facsimile receiver. To power the preamp unit, set J23 on the RCV Board (in the FAX-30) to the "ACTIVE" position. See paragraph 7.4.

### 7.3 Wiring

Four cables are connected to the facsimile receiver: antenna cable, Net Cable (or PC cable), power cable, ground wire. Connect them as shown in the figure below. For detailed information, see the interconnection diagram on page S-1.

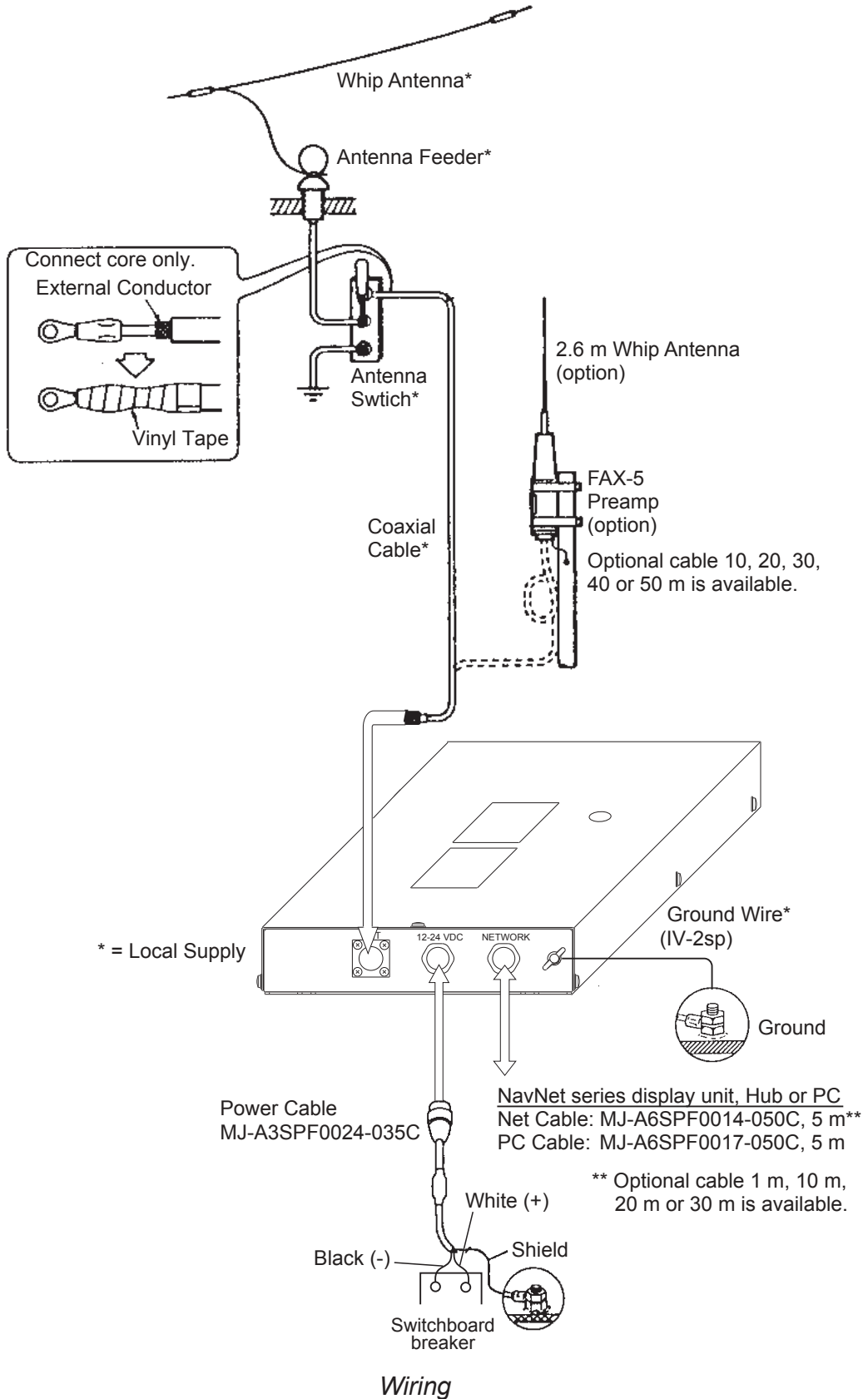

**Power cable**

Connect the power cable (supplied) to the power source; white wire to positive [+] terminal and black wire to negative [-] terminal.

**Ground wire**

Ground the equipment to prevent noise and interference and enable reception of weak signals. Run the ground wire (local supply) between the ground terminal on the facsimile receiver and the ship's grounding bus.

**Preamp unit**

Connect its coaxial cable directly to the antenna connector on the FAX-30. Note that an extension cable kit (option) is available, in lengths of 10, 20, 30, 40 and 50 m.

**Wire or whip antenna**

A junction box or antenna switch (local supply) is required since the connection at the FAX-30 is made with a coaxial cable. Connect a feeder wire between the antenna and the junction box or antenna switch. Attach coaxial connector (option) to a 50 ohm coaxial cable as below and connect the cable between the junction box and the FAX-30. If the connector does not fit the cable, use appropriate adaptor (option).

Cable type 7C-2V, RG-8/U, RG-213/U, etc.

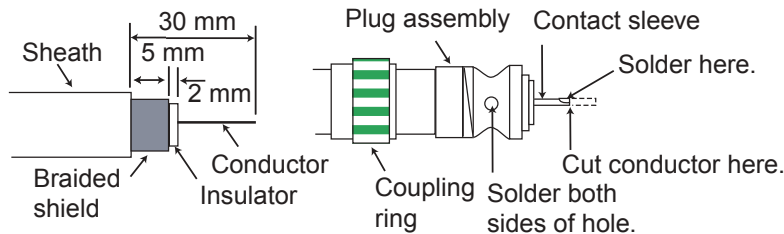

Cable type 5D-2V, 5C-2V, RG-5/U, 3C-2V, RG-58/U, etc.

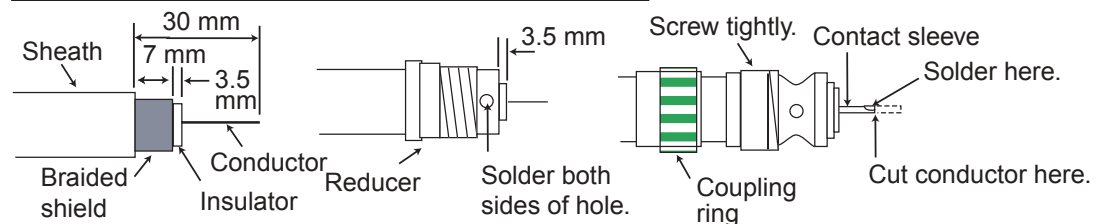
*Attachment of antenna connector*

**Note:** The cables 3C-2V, 5C-2V, 5D-2V and 7C-2V are JIS (Japan Industry Standard) cables. If these are not available use equivalent cables, referring to the table on the next page for specifications.

## 7. INSTALLATION

### *JIS cable specifications*

Type	Inner Conductor		Insulation		Outer Conductor		Jacket			Cond. resistance (Max.) (20°C) (Ω/km)	Nominal attenuation 10 MHz (dB/km)	Capacitance (pF/m)	Approx. mass (kg/km)
	Stranding (No./mm)	Dia. (mm)	Thick (mm)	Dia (mm)	Braid		Dia. (mm)	Thick (mm)	Dia. (mm)				
					Dia./	Pitch							
3C-2V	1/0.5	0.5	1.3	3.1	0.14/5/24	26	3.8	0.8	5.4±0.5	91.4	42	67±3	42
5C-2V	1/0.8	0.8	2.05	4.9	0.14/7/24	42	5.7	0.9	7.4±0.5	35.9	27	67±3	74
7C-2V	7/0.4	1.2	3.05	7.3	0.18//8/24	45	8.2	1.1	10.4±0.5	20.7	22	67±3	140
5D-2V	1/1.4	1.4	1.7	4.8	0.14/7/24	42	5.5	0.9	7.3±0.5	11.7	27	100±4	80

## 7.4 Supplying Power to the Preamp Unit

The preamp unit is powered with 12 VDC power fed from the facsimile receiver. To power the preamp unit, do the following:

1. Disconnect the power cable from the FAX-30.
2. Unfasten eight screws marked with the arrows below to remove the cover.

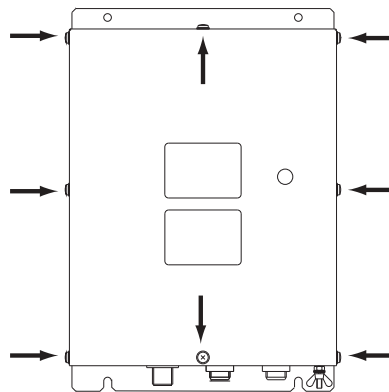

*FAX-30, top view*

3. Set the jumper block J23 in the “ACT(IVE)” position. See the figure below for the “ACT” position.

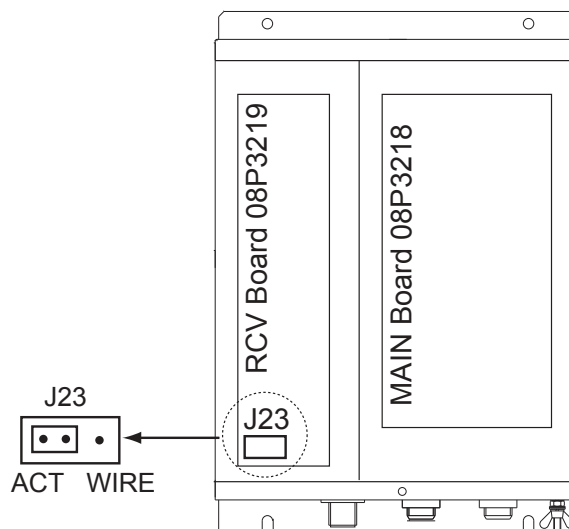

*FAX-30, top view, cover removed*

4. Close the cover and connect the power cable.

## 7.5 Browser, PC Settings

### 7.5.1 Browser settings

Set your browser as shown in the procedures below. The procedure may be different depending on browser version.

#### **Internet Explorer (Version 5.5)**

1. Start up the Internet Explorer.
2. Click Tools on the menu bar.
3. Click Internet Options.
4. General is selected; click “Settings” at “Temporary Internet files.”
5. Click the radio button “Every visit to the page” at “Check for newer versions of stored pages.”
6. Click OK.
7. Click Security tab.
8. Click Custom Level button.
9. At the item Scripting, click Enable for both “Active scripting” and “Scripting of Java Applets.”
10. Click OK.
11. Click Connections tab.
12. Click “Never dial a connection”.
13. Click LAN Settings button.
14. Uncheck “Use a proxy server” at “Proxy server.”
15. Click OK.
16. Click OK again.

#### **Netscape Navigator (Version 4.78)**

1. Start up the Netscape Navigator.
2. Click the Edit menu.
3. Click Preferences.
4. Open the Advanced menu.
5. Check “Automatically load images and other data types,” “Enable Java,” “Enable Java script” and “Enable style sheets.”
6. Click “Cache” at Advanced.
7. Choose “Every time” in “Page in cache is compared to page on network.”
8. Click “Proxies” at Advanced.
9. Choose “Direct connection to internet.”
10. Click OK.

### 7.5.2 PC settings

The PC communicates with the FAX-30 via Internet protocol TCP/IP. Therefore, set IP address on the PC as below.

1. Start up the PC and open the Control Panel folder.
2. Open the Network and Dial-up Connections folder.
3. Double-click Local Area Connection.
4. Click Properties.
5. Check Internet Protocol (TCP/IP).
6. Click Properties.
7. Choose "Use the following IP address."
8. Set the IP address for 172.31.100.100.
9. Set the Subnet mask for 255.255.0.0.

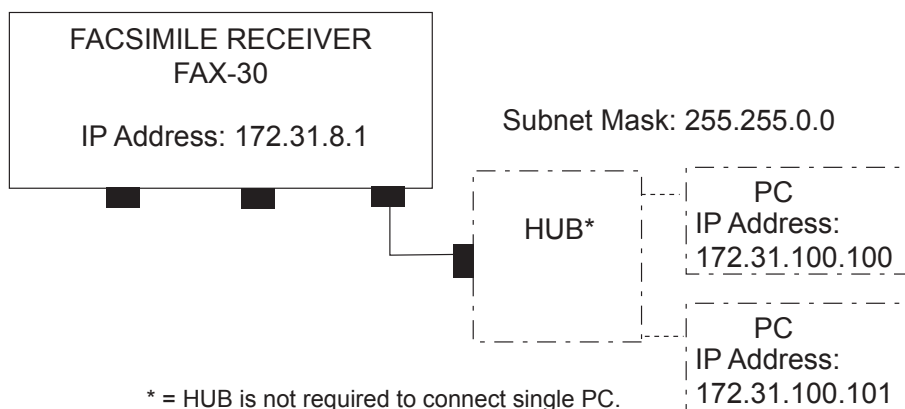

*IP address*

10. Click OK.
11. Click OK.
12. Click Close button.
13. Turn the PC off and on again.
14. Start up the browser.
15. Enter the FAX-30's URL: <http://172.31.8.1> and press the [Enter] key.

The facsimile receiver top display should appear. If it does not appear, recheck above settings.



*Facsimile receiver top display*

# APPENDIX

## Facsimile Stations

### Facsimile station map

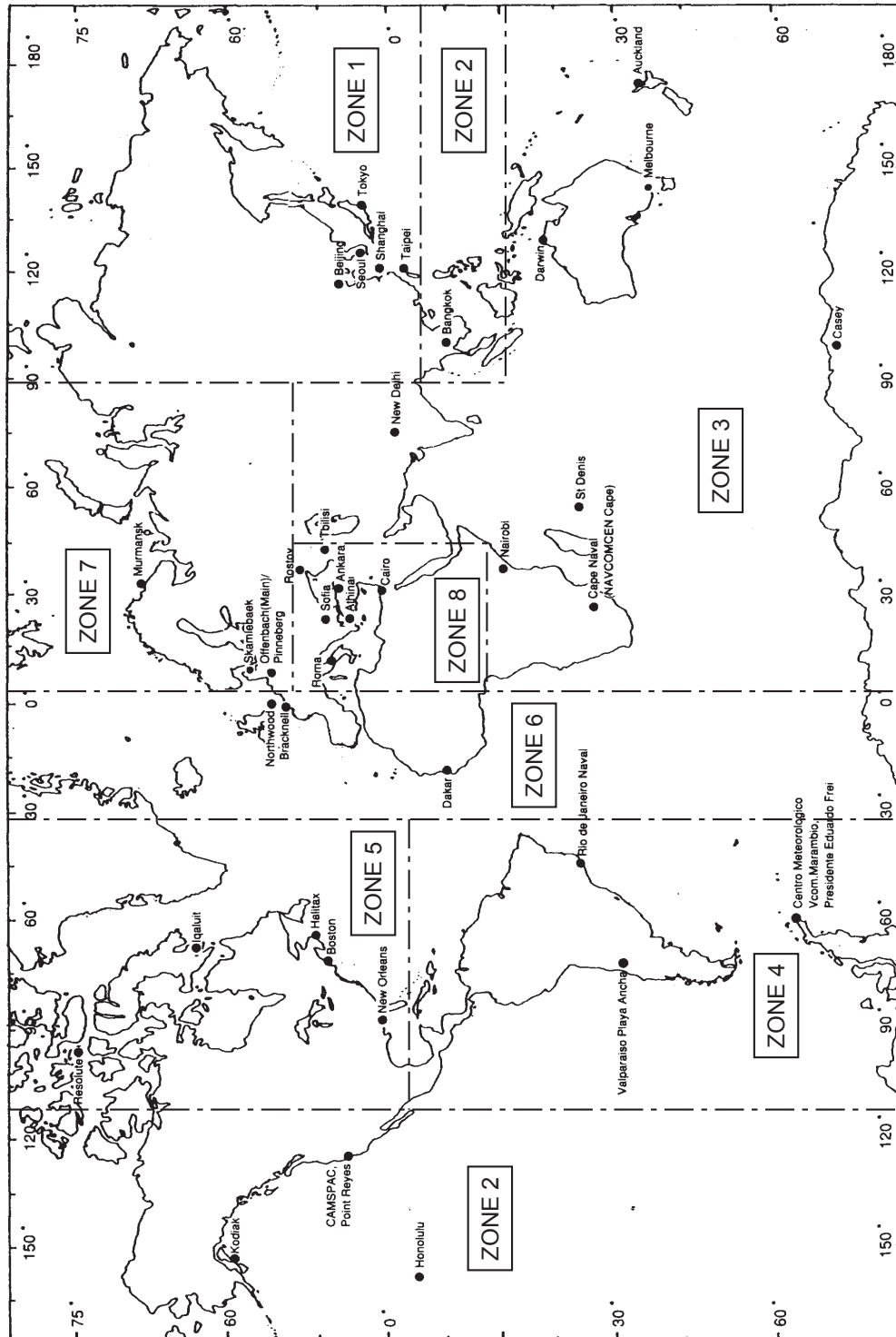

Location of facsimile stations

**Facsimile station list (by zone)**

<b>ZONE 1</b>		<b>NORTH PACIFIC OCEAN WESTERN PART</b>	
STA-TION	CALL SIGN	TRANSMITTED FROM	
0	JMH	Tokyo	JAPAN
1	JMJ	Tokyo	JAPAN
2	JJC	Tokyo	JAPAN
3	9MG *	Tokyo	Via MALAYSIA
4	JFA	Tokyo	JAPAN
5	3SD	Beijing	CHINA
6	BAF	Beijing	CHINA
7	BDF	Shanghai	CHINA
8	BMF	Taipei	TAIWAN
9	HLL	Seoul	KOREA
	AUX		

<b>ZONE 4</b>		<b>SOUTH ATLANTIC OCEAN</b>	
STA-TION	CALL SIGN	TRANSMITTED FROM	
0	CLX	Casablanca	CUBA
1	FFP	Fort de France	MARTINIQUE
2	GYA		
3	LOR	Puerto Brelgrano	ARGENTINA
4	PWZ	Rio de Janeiro	BRASIL
	PRO *	Orinda	BRASIL
5	LRO	Buenos Aires	ARGENTINA
6	VLM	Cassy	ANTARCTICA
7	CAN	CMIRL FREI	South Shetland Is.
8	LSB	CNURLMARAMBIO	ANTARCTIC
9	CBV	Valparaiso	CHILE

<b>ZONE 2</b>		<b>NORTH PACIFIC OCEAN EASTERN PART</b>	
STA-TION	CALL SIGN	TRANSMITTED FROM	
0	NPN	Guam	MARIANA IS.
1	NPO	Sanglay Point	PHILIPPINES
2	HSW	Bangkok	THAILAND
3	NPM	Pearl Harbor	USA
4	KVM	Honolulu	USA
5	NOJ	Kodiak, Alaska	USA
6	GKN	Esquimalt	CANADA
7	NMC	California	USA
8	ELK	Nebraska	USA
9	AUX		

<b>ZONE 7</b>		<b>NORTH ATLANTIC OCEAN NORTHERN PART</b>	
STA-TION	CALL SIGN	TRANSMITTED FROM	
0	DCF	Offenbach	GERMANY
1	DDK	Offenbach	GERMANY
	DDH *		
2	OXT	Copenhagen	DENMARK
3	OLT	Praha-Modrany	CZECHOSLOVAKIA
4	SMA	Norrkoping	SWEDEN
5	RBW	Murmansk	RUSSIA
6	OFA	Helsinki	FINLAND
7	OFW	Vaasa	FINLAND
8	NOV		
9	AUX		

<b>ZONE 5</b>		<b>NORTH ATLANTIC OCEAN WESTERN PART</b>	
STA-TION	CALL SIGN	TRANSMITTED FROM	
0	NMG	New Orleans	USA
1	NMF	Boston	USA
2	NIK	Boston	USA
3	CFH	Halifax	CANADA
4	VFF	RESOLUTE	CANADA
5	OXT	Skamlebaek	GREENLAND
6	AUX		
7	AUX		
8	AUX		
9	AUX		

<b>ZONE 3</b>		<b>SOUTH PACIFIC OCEAN, INDIAN OCEAN, PERSIAN GULF</b>	
STA-TION	CALL SIGN	TRANSMITTED FROM	
0	VMM	Australia west	AUSTRALIA
1	VMC	Australia east	AUSTRALIA
2	ZKLF	Auckland	NEW ZEALAND
3	NPN	Guam	Via AUSTRALIA
		Guam	Via JAPAN
4	ATA	New Delhi	INDIA
5	EPD	Teheran	IRAN
6	5YE	Nairobi	KENYA
7	ZSJ	CAPE NAVAL	SOUTH AFRICA
8	HXP	Denis METEO	MAURITIUS
9	RUZU	Molodezhnaya	RUSSIA

<b>ZONE 8</b>		<b>MEDITERRANEAN SEA</b>	
STA-TION	CALL SIGN	TRANSMITTED FROM	
0	IMB	Rome	ITALY
1	SVJ	Athens	GREECE
2	YZZ	Beograd	YUGOSLAVIA
3	LZJ2	Sofia	BULGARIA
4	YMA	Ankara	TURKEY
5	RBV	Tashkent 1	UZBEKISTAN
6	RBX	Tashkent 2	UZBEKISTAN
7	SUU	Cairo	EGYPT
8	JED	Jeddah	SAUDI ARABIA
9	RIS	Tbilisi	GRUZIIA

<b>ZONE 6</b>		<b>NORTH ATLANTIC OCEAN EASTERN PART</b>	
STA-TION	CALL SIGN	TRANSMITTED FROM	
0	GYA	Northwood	UK
1	AOK	Rota	SPAIN
2	MAD	Madrid	SPAIN
3	NHY	Kenitora	MOROCCO
4	6VU	Dakar	SENEGAL
5	AUX		
6	AUX		
7	AUX		
8	AUX		
9	AUX		

<b>ZONE 1</b>		<b>NORTH PACIFIC OCEAN WESTERN PART</b>	
STA-TION	CALL SIGN	TRANSMITTED FROM	
0	JMH	Tokyo	JAPAN
1	JMJ	Tokyo	JAPAN
2	JJC	Tokyo	JAPAN
3	9MG *	Tokyo	Via MALAYSIA
4	JFA	Tokyo	JAPAN
5	3SD	Beijing	CHINA
6	BAF	Beijing	CHINA
7	BDF	Shanghai	CHINA
8	BMF	Taipei	TAIWAN
9	HLL	Seoul	KOREA
	AUX		

**FACSIMILE STATION LIST**

ZONE [0] and [9] are allocated for private channels.  
(10 channels each for 10 stations)  
\*: Callsign not displayed.

## Facsimile station list (alphabetical order)

	Nation	City	Zone No.	Station No.	Call sign	Remarks
A	ANTARCTIC	Casey	4	6	VLM	
		Meteorologic.	4	8	LSB	
	ARGENTINE	Buenos Aires	4	5	LRO	
		Puerto Belgrano	4	3	LOR	
	AUSTRALIA	Darwin	3	0	AXI	
		Melbourne	3	1	AXM	
B	BRAZIL	Olinda	4	4	PPO	
		Rio de Janeiro	4	4	PWZ	
	BULGARIA	Sofia	8	3	LZJ2	
C	CANADA	Iqaluit	5	4	VFF	
		Esquimalt	2	6	CKN	
		Halifax	5	3	CFH	
	CHILE	Valparaiso	4	9	CBV	
	CHINA	Beijing	1	4	3SD	
		Beijing	1	5	BAF	
		Shanghai	1	6	BDF	
	CUBA	Casablanca	4	0	CLX	
	CZECHOSLOVAKIA	Praha-Modrany	7	3	OLT	
D	DENMARK	Copenhagen	7	2	OXT	
E	EGYPT	Cairo	8	7	SUU	
F	FINLAND	Helsinki	7	6	OFA	
		Vaasa	7	7	OFW	
G	GREECE	Athens	8	1	SVJ	
	GREENLAND	Skamlebeak	5	5	OXT	
I	INDIA	New Delhi	3	4	ATA	
	IRAN	Teheran	3	5	EPD	
	ITALY	Rome	8	0	IMB	
J	JAPAN	Tokyo	1	0	JMH	No.1
		Tokyo	1	1	JMJ	No.2
		Tokyo	1	2	JJC	JMSA & Kyodo
		Tokyo	1	3	9VF	
		Tokyo	1	3	JFA	Chuo Gyogyo
K	KENYA	Nairobi	3	6	5YE	
	KOREA	Seoul	1	8	HLL	
M	MARIANA IS.	Guam	2	0	NPN	US Navy
			3	3	NPN	Via Australia
			3	3	NPN	Via Japan
	MARTINIQUE	Fort de France	4	1	FFP	
	MAURITIUS	Sain Denis	3	8	HXP	
	MOROCCO	Kenitora	6	3	NHY	
N	NEW ZEALAND	Auckland	3	2	ZKLF	
P	PHILIPPINES	Sanglay Point	2	1	NPO	US Navy
S	SENEGAL	Dakar	6	4	6VU	
	SAUDI ARABIA	Jeddah	8	8	JED	
	SOUTH AFRICA	Pretoria	3	7	ZRO	
	SOUTH SHETLAND IS.	Meteorologic	4	7	CAN	
	SPAIN	Rota	6	1	AOK	US Navy
		Madrid	6	2	MAD	
	SWEDEN	Norrkoping	7	4	SMA	
T	TAIWAN	Taipei	1	7	BMF	
	THAILAND	Bangkok	2	2	HSW	
	TURKEY	Ankara	8	4	YMA	
U	UK	Northwood	6	0	GVA	For S.A.
	USA	Boston	5	2	NIK	
		Boston	5	1	NMF	
		Honolulu	2	4	KVM	
		Kodiak Alaska	2	5	NOJ	
		Nebraska	2	8	ELK	
		New Orleans	5	0	NMG	
		Pearl Harbor	2	3	NPM	
		San Francisco	2	7	NMC	
	UZBEKISTAN	Tashkent 1	8	5	RBV	US Navy
		Tashkent 2	8	6	RBX	
	RUSSIA	Molodezhnaya	3	9	RUZU	
		Murmansk	7	5	RBW	
W	GERMANY	Hamburg	7	1	DDK	
		Offenbach	7	0	DDH	
			7	0	DCF	
Y	YUGOSLAVIA	Belgrade	8	2	YZZ	

# Navtex Stations

## Navtex stations map

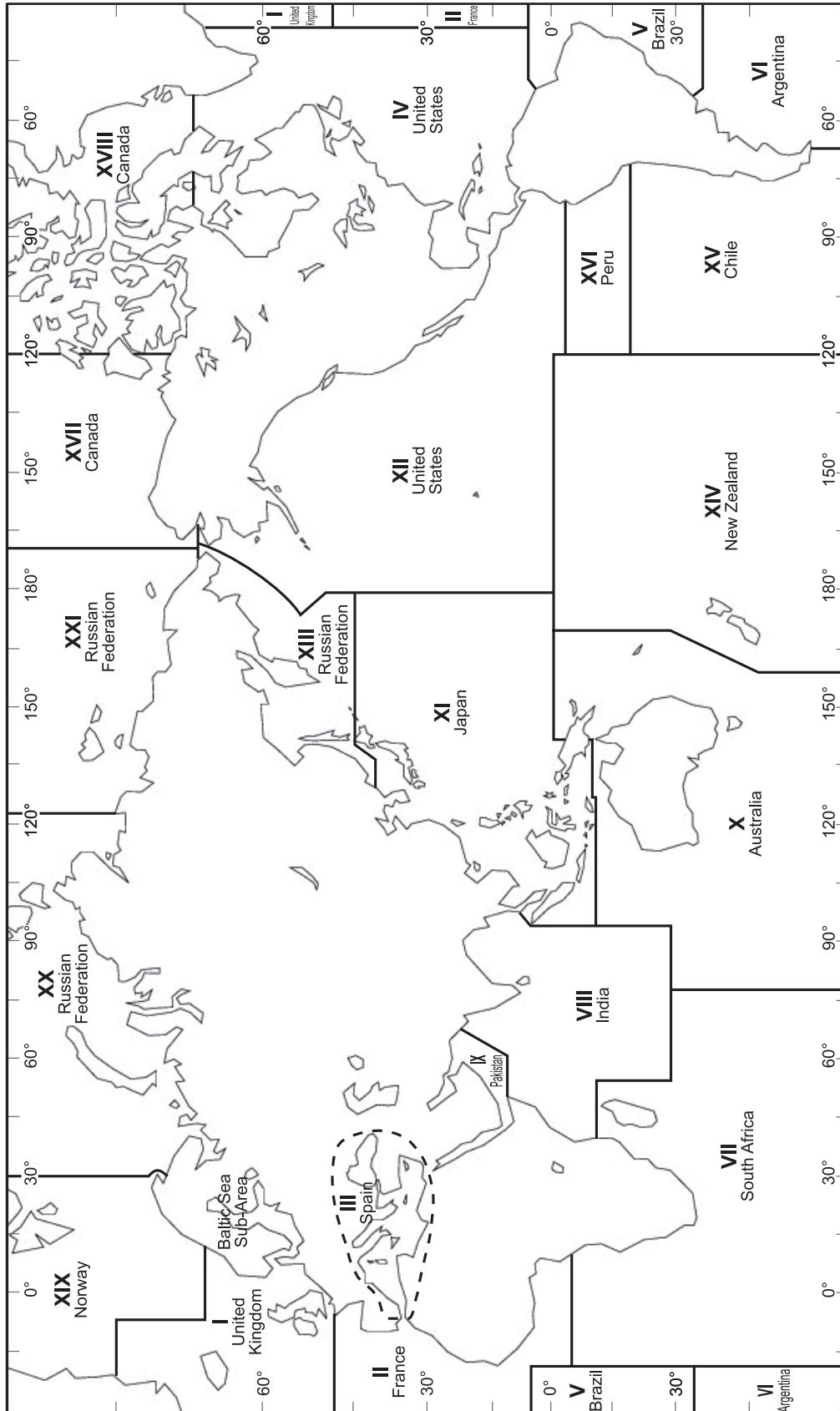

Location of navtex stations

## Navtex stations list

NAV area	Country	Station	Latitude	Longitude	Freq. (kHz)	Area (nm)	Station ID	Broadcast schedule (UTC)
I	Belgium	Oostende	51° 11' N	002° 48' E	518	55	V	0330, 0730, 1130, 1530, 1930, 2330
							T	0310, 0710, 1110, 1510, 1910, 2310
					490		B	0010, 0410, 0810, 1210, 1610, 2010
	Estonia	Tallinn	59° 28' N	024° 21' E	518	250	U	0320, 0720, 1120, 1520, 1920, 2320
	Foroyar (Denmark)	Torshavn	62° 01' N	006° 48' W	518	250	D	0030, 0430, 0830, 1230, 1630, 2030
	Germany	Hamburg	53° 40' N	009° 48' E	518	400	S	0300, 0700, 1100, 1500, 1900, 2300
					490		L	0150, 0550, 0950, 1350, 1750, 2150
	Iceland	Grindavik	63° 47' N	022° 31' W	518	550	X	0350, 0750, 1150, 1550, 1950, 2350
					490		K	0140, 0540, 0940, 1340, 1740, 2140
		Reykjavik	64° 05' N	021° 51' W	518	550	R	0250, 0650, 1050, 1450, 1850, 2250
					490		R	0320, 0720, 1120, 1520, 1920, 2320
	Saudanes	66° 11' N	018° 57' W	490	550	E	0040, 0440, 0840, 1240, 1640, 2040	
	Ireland	Valencia	51° 56' N	010° 21' W	518	400	W	0340, 0740, 1140, 1540, 1940, 2340
		Malin Head	55° 22' N	007° 21' W	518	400	Q	0240, 0640, 1040, 1440, 1840, 2240
	Netherlands	Den Helder	52° 06' N	004° 15' E	518	110	P	0230, 0630, 1030, 1430, 1830, 2230
	Norway	Rogaland	58° 48' N	005° 34' E	518	450	L	0150, 0550, 0950, 1350, 1750, 2150
		Orlandet	63° 40' N	009° 33' E	518	450	N	0210, 0610, 1010, 1410, 1810, 2210
		Tjome (Jeloya)	59° 26' N	010° 34' E	518	450	M	2000, 0600, 1000, 1400, 1800, 2200
	Sweden	Bjuroklubb	64° 28' N	021° 35' E	518	300	H	0110, 0510, 0910, 1310, 1710, 2110
		Gislovshammar	55° 29' N	014° 19' E	518	300	J	0130, 0530, 0930, 1330, 1730, 2130
		Grimeton	57° 06' N	012° 23' E	518	300	I	0120, 0520, 0920, 1320, 1720, 2120
United Kingdom	Cullercoats	55° 02' N	001° 26' W	518	270	G	0100, 0500, 0900, 1300, 1700, 2100	
				490		U	0320, 0720, 1120, 1520, 1920, 2320	
	Portpatrick	54° 51' N	005° 07' W	518	270	O	0220, 0620, 1020, 1420, 1820, 2220	
				490		C	0020, 0420, 0820, 1220, 1620, 2020	
	Niton	50° 35' N	001° 18' W	518	270	E	0040, 0440, 0840, 1240, 1640, 2040	
						K	0140, 0540, 0940, 1340, 1740, 2140	
				490		I	0120, 0520, 0920, 1320, 1720, 2120	
					T	0310, 0710, 1110, 1510, 1910, 2310		

(Continued on next page)

APPENDIX

NAV area	Country	Station	Latitude	Longitude	Freq. (kHz)	Area (nm)	Station ID	Broadcast schedule (UTC)
II	Cape Verde	Sao Vicente	16° 51' N	025° 00' W	518	250	U	0320, 0720, 1120, 1520, 1920, 2320
					490		P	0310, 0710, 1110, 1510, 1910, 2310
	France	Corsen	48° 28' N	005° 03' W	518	300	A	0000, 0400, 0800, 1200, 1600, 2000
					490		E	0040, 0440, 0840, 1240, 1640, 2040
	Morocco	Casablanca	33° 36' N	007° 38' W	518	400	M	0200, 0600, 1000, 1400, 1800, 2200
	Portugal	Horta	38° 32' N	028° 38' W	518	640	F	0050, 0450, 0850, 1250, 1650, 2050
					490		J	0130, 0530, 0930, 1330, 1730, 2130
		Monsanto	38° 44' N	009° 11' W	518	530	R	0250, 0650, 1050, 1450, 1850, 2250
					490		G	0100, 0500, 0900, 1300, 1700, 2100
	Senegal	Dakar	14° 46' N	017° 21' E	518	200	C	0020, 0420, 0820, 1220, 1620, 2020
					490		M	0200, 0600, 1000, 1400, 1800, 2200
	Spain	Coruna	43° 21' N	008° 27' W	518	400	D	0030, 0430, 0830, 1230, 1630, 2030
					490		W	0340, 0740, 1140, 1540, 1940, 2340
		Las Palmas	28° 10' N	015° 25' W	518	400	I	0120, 0520, 0920, 1320, 1720, 2120
					490		A	0000, 0400, 0800, 1200, 1600, 2000
		Tarifa	36° 01' N	005° 34' W	518	400	G	0100, 0500, 0900, 1300, 1700, 2100
					490		T	0310, 0710, 1110, 1510, 1910, 2310
	III	Algeria	Algiers	36° 44' N	003° 10' E	518	250	B
490						V		0330, 0730, 1130, 1530, 1930, 2330
Bulgaria		Varna	43° 04' N	027° 46' E	518	350	J	0130, 0530, 0930, 1330, 1730, 2130
Croatia		Split	43° 30' N	016° 29' E	518	85	Q	0240, 0640, 1040, 1440, 1840, 2240
Cyprus		Cyprus	35° 03' N	033° 17' E	518	200	M	0200, 0600, 1000, 1400, 1800, 2200
Egypt		Alexandria	31° 12' N	029° 52' E	518	350	N	0210, 0610, 1010, 1410, 1810, 2210
France		La Garde	43° 06' N	005° 59' E	518	250	W	0340, 0740, 1140, 1540, 1940, 2340
					490		S	0300, 0700, 1100, 1500, 1900, 2300
Greece		Iraklion	35° 20' N	025° 07' E	518	280	H	0110, 0510, 0910, 1310, 1710, 2110
		Kerkyra	39° 37' N	019° 55' E	518	280	K	0140, 0540, 0940, 1340, 1740, 2140
		Limnos	39° 52' N	025° 04' E	518	280	L	0150, 0550, 0950, 1350, 1750, 2150
Iran		Now Shahr	36° 42' N	052° 33' E	490	250	J	0130, 0530, 0930, 1330, 1730, 2130
Israel		Haifa	32° 49' N	035° 00' E	518	200	P	0020, 0420, 0820, 1220, 1620, 2020

(Continued on next page)

NAV area	Country	Station	Latitude	Longitude	Freq. (kHz)	Area (nm)	Station ID	Broadcast schedule (UTC)	
III	Italy	La Maddalena	41° 13' N	009° 23' E	518	400	R	0250, 0650, 1050, 1450, 1850, 2250	
					490		I	0120, 0520, 0920, 1320, 1720, 2120	
		Sellia Marina	38° 52' N	016° 43' E	518	400	V	0330, 0730, 1130, 1530, 1930, 2330	
					490		W	0340, 0740, 1140, 1540, 1940, 2340	
		Mondolfo	43° 44' N	013° 08' E	518	400	U	0320, 0720, 1120, 1520, 1920, 2320	
					490		E	0040, 0440, 0840, 1240, 1640, 2040	
		Tunis	36° 53' N	010° 11' E	518	400	T	0310, 0710, 1110, 1510, 1910, 2310	
		Malta	Malta	35° 49' N	014° 32' E	518	400	O	0220, 0620, 1020, 1420, 1820, 2220
		Romania	Constanta	44° 06' N	028° 37' E	490	400	L	0550, 0950, 1350, 1750, 2150, 0150
		Russia	Astrakhan	45° 47' N	047° 33' E	518	250	W	0340, 0740, 1140, 1540, 1940, 2340
	Novorossiysk		44° 36' N	037° 58' E	518	300	A	0300, 0700, 1100, 1500, 1900, 2300	
	Spain	Valencia	38° 43' N	000° 09' E	518	300	X	0350, 0750, 1150, 1550, 1950, 2350	
					490		M	0200, 0600, 1000, 1400, 1800, 2200	
	Turkey	Istanbul	41° 04' N	028° 57' E	518	300	D	0030, 0430, 0830, 1230, 1630, 2030	
					490		B	0010, 0410, 0810, 1210, 1610, 2010	
		Samsun	41° 17' N	036° 20' E	518	300	E	0040, 0440, 0840, 1240, 1640, 2040	
					490		A	0000, 0400, 0800, 1200, 1600, 2000	
		Antalya	36° 53' N	030° 42' E	518	300	F	0050, 0450, 0850, 1250, 1650, 2050	
					490		D	0030, 0430, 0830, 1230, 1630, 2030	
		Izmir	38° 21' N	026° 35' E	518	300	I	0120, 0520, 0920, 1320, 1720, 2120	
					490		C	0020, 0420, 0820, 1220, 1620, 2020	
	Ukraine	Kerch	45° 22' N	036° 29' E	518	120	G	0100, 0500, 0900, 1300, 1700, 2100	
					490		U	0320, 0720, 1120, 1520, 1920, 2320	
		Odessa	46° 29' N	030° 44' E	518	280	C	0230, 0630, 1030, 1430, 1830, 2230	
490					X		0350, 0750, 1150, 1550, 1950, 2350		
IV	Bermuda (UK)	Bermuda	32° 23' N	064° 41' W	518	280	B	0010, 0410, 0810, 1210, 1610, 2010	
	Canada	Sept Iles	50° 11' N	066° 07' W	518	300	C	0020, 0420, 0820, 1220, 1620, 2020	
					490		D	0035, 0435, 0835, 1235, 1635, 2035	
		Wiaraton	44° 20' N	081° 10' W	518	300	H	0110, 0510, 0910, 1310, 1710, 2110	
		St. Johns	47° 30' N	052° 40' W	518	300	O	0220, 0620, 1020, 1420, 1820, 2220	
		Thunder Bay	48° 25' N	089° 20' W	518	300	P	0230, 0630, 1030, 1430, 1830, 2230	
		Sydney, NS	46° 10' N	060° 00' W	518	300	Q	0240, 0640, 1040, 1440, 1840, 2240	
					490		J	0255, 0655, 1055, 1455, 1855, 2255	
		Yarmouth	43° 45' N	066° 10' W	518	300	U	0320, 0720, 1120, 1520, 1920, 2320	
	490				V		0335, 0735, 1135, 1535, 1935, 2335		
Montreal	45° 41' N	073° 16' W	518	400	W	0340, 0740, 1140, 1540, 1940, 2340			

(Continued on next page)

APPENDIX

NAV area	Country	Station	Latitude	Longitude	Freq. (kHz)	Area (nm)	Station ID	Broadcast schedule (UTC)
IV	Canada	Labrador	53° 42' N	057° 01' W	518	300	X	0350, 0750, 1150, 1550, 1950, 2350
		Iqaluit, NU	63° 43' N	068° 33' W	518	300	T	0310, 0710, 1110, 1510, 1910, 2310
					490		S	0300, 0700, 1100, 1500, 1900, 2300
	Greenland	Kook Island	64° 04' N	052° 01' W	518	400	W	0340, 0740, 1140, 1540, 1940, 2340
		Simiutaq	60° 37' N	046° 21' W	518	400	M	0200, 0600, 1000, 1400, 1800, 2200
	United States	Miami	25° 37' N	080° 23' W	518	240	A	0000, 0400, 0800, 1200, 1600, 2000
		Boston	41° 43' N	070° 30' W	518	200	F	0050, 0450, 0850, 1250, 1650, 2050
		New Orleans	29° 53' N	089° 57' W	518	200	G	0100, 0500, 0900, 1300, 1700, 2100
		Portsmouth	36° 43' N	076° 00' W	518	280	N	0210, 0610, 1010, 1410, 1810, 2210
		San Juan	18° 28' N	067° 04' W	518	200	R	0250, 0650, 1050, 1450, 1850, 2250
		Charleston	32° 08' N	081° 42' W	518	200	E	0040, 0440, 0840, 1240, 1640, 2040
Netherlands Antilles		Curacao	12° 10' N	068° 52' W	518	400	H	0110, 0510, 0910, 1310, 1710, 2110
V	NIL							
VI	Argentina	Ushaia	54° 48' S	068° 18' W	518	280	M	0200, 0600, 1000, 1400, 1800, 2200
					490		A	0000, 0400, 0800, 1200, 1600, 2000
		Rio Gallegos	51° 37' S	069° 03' W	518	280	N	0210, 0610, 1010, 1410, 1810, 2210
					490		B	0010, 0410, 0810, 1210, 1610, 2010
		Rivadavia	45° 51' S	067° 25' W	518	280	O	0220, 0620, 1020, 1420, 1820, 2220
					490		C	0020, 0420, 0820, 1220, 1620, 2020
		Bahia Blanca	38° 43' S	062° 06' W	518	280	P	0230, 0630, 1030, 1430, 1830, 2230
					490		D	0230, 0630, 1030, 1430, 1830, 2230
		Mar del Plata	38° 03' S	057° 32' W	518	280	Q	0240, 0640, 1040, 1440, 1840, 2240
					490		E	0040, 0440, 0840, 1240, 1640, 2040
		Buenos Aires	34° 36' S	058° 22' W	518	560	R	0250, 0650, 1050, 1450, 1850, 2250
					490		F	0050, 0450, 0850, 1250, 1650, 2050
	Uruguay	La Paloma	34° 40' S	054° 09' W	518	280	F	0050, 0450, 0850, 1250, 1650, 2050
490					A		0000, 0400, 0800, 1200, 1600, 2000	
VII	Namibia	Walvis Bay	23° 03' S	014° 37' E	518	378	B	0010, 0410, 0810, 1210, 1610, 2010
	South Africa	Cape Town	33° 40' S	018° 43' E	518	300	C	0020, 0420, 0820, 1220, 1620, 2020
		P Elizabeth	34° 02' S	025° 33' E	518	300	I	0120, 0520, 0920, 1320, 1720, 2120
		Durban	29° 48' S	030° 49' E	518	300	O	0220, 0620, 1020, 1420, 1820, 2220
VIII	India	Mumbai	19° 05' N	072° 50' E	518	250	G	0100, 0500, 0900, 1300, 1700, 2100
		Madras	13° 05' N	080° 17' E	518	400	P	0230, 0630, 1030, 1430, 1830, 2230
	Mauritius	Mauritius	20° 10' S	057° 28' E	518	400	C	0020, 0420, 0820, 1220, 1620, 2020

(Continued on next page)

NAV area	Country	Station	Latitude	Longitude	Freq. (kHz)	Area (nm)	Station ID	Broadcast schedule (UTC)
IX	Bahrain	Hamala	26° 09' N	050° 28' E	518	300	B	0010, 0410, 0810, 1210, 1610, 2010
	Egypt	Ismailia	30° 28' N	032° 22' E	518	200	X	0350, 0750, 1150, 1550, 1950, 2350
		Kosseir	26° 06' N	034° 17' E	518	400	V	0330, 0730, 1130, 1530, 1930, 2330
	Iran	Bandar Abbas	27° 07' N	056° 03' E	518	300	F	0050, 0450, 0850, 1250, 1650, 2050
					490		I	0120, 0520, 0920, 1320, 1720, 2120
		Bushehr	28° 59' N	050° 49' E	518	300	A	0000, 0400, 0800, 1200, 1600, 2000
					490		D	0030, 0430, 0830, 1230, 1630, 2030
	Oman	Muscat	23° 36' N	058° 30' E	518	270	M	0200, 0600, 1000, 1400, 1800, 2200
	Pakistan	Karachi	24° 51' N	067° 03' E	518	400	P	0230, 0630, 1030, 1430, 1830, 2230
	Saudi Arabia	Jeddah	21° 23' N	039° 10' E	518	390	H	0705, 1305, 1905
Damman		26° 26' N	050° 06' E	518	390	G	0100, 0500, 0900, 1300, 1700, 2100	
X	NIL							
XI	China	Sanya	18° 14' N	109° 30' E	518	250	M	0200, 0600, 1000, 1400, 1800, 2200
		Guangzhou	23° 09' N	113° 29' E	518	250	N	0210, 0610, 1010, 1410, 1810, 2210
		Fuzhou	26° 01' N	119° 18' E	518	250	O	0220, 0620, 1020, 1420, 1820, 2220
		Shanghai	31° 08' N	121° 33' E	518	250	Q	0240, 0640, 1040, 1440, 1840, 2240
		Dalian	38° 52' N	121° 31' E	518	250	R	0250, 0650, 1050, 1450, 1850, 2250
	Hong Kong	Hong Kong	22° 13' N	114° 15' E	518	400	L	0150, 0550, 0950, 1350, 1750, 2150
	Indonesia	Jayapura	02° 31' S	140° 43' E	518	300	A	0000, 0400, 0800, 1200, 1600, 2000
		Ambon	03° 42' S	128° 12' E	518	300	B	0010, 0410, 0810, 1210, 1610, 2010
		Makassar	05° 06' S	119° 26' E	518	300	D	0030, 0430, 0830, 1230, 1830, 2030
		Jakarta	06° 06' S	106° 54' E	518	300	E	0040, 0440, 0840, 1240, 1640, 2040
	Japan	Otaru	43° 19' N	140° 27' E	518	400	J	0130, 0530, 0930, 1330, 1730, 2130
		Kushiro	42° 57' N	144° 36' E	518	400	K	0140, 0540, 0940, 1340, 1740, 2140
		Yokohama	35° 14' N	139° 55' E	518	400	I	0120, 0520, 0920, 1320, 1720, 2120
		Moji	34° 01' N	130° 56' E	518	400	H	0110, 0510, 0910, 1310, 1710, 2110
		Naha	26° 05' N	127° 40' E	518	400	G	0100, 0500, 0900, 1300, 1700, 2100
	Korea, Republic of	Chukpyong	37° 03' N	129° 26' E	518	200	V	0330, 0730, 1130, 1530, 1930, 2330
					490		J	0130, 0530, 0930, 1330, 1730, 2130
		Pyongsan	35° 36' N	126° 29' E	518	200	W	0340, 0740, 1340, 1540, 1940, 2340
					490		K	0140, 0540, 0940, 1340, 1740, 2140
	Malaysia	Penang	05° 26' N	100° 24' E	518	350	U	0320, 0720, 1120, 1520, 1920, 2320
		Miri	04° 28' N	114° 01' E	518	350	T	0310, 0710, 1110, 1510, 1910, 2310
		Sandakan	05° 54' N	118° 00' E	518	350	S	0300, 0700, 1100, 1500, 1900, 2300

(Continued on next page)

APPENDIX

NAV area	Country	Station	Latitude	Longitude	Freq. (kHz)	Area (nm)	Station ID	Broadcast schedule (UTC)	
XI	North Korea	Hamhung	39° 50' N	127° 41' E	518	200	E	0040, 0440, 0840, 1240, 1840, 2240	
					490		B	0010, 0410, 0810, 1210, 1610, 2210	
		Pyongyang	38° 55' N	125° 43' E	518	200	D	0030, 0430, 0830, 1230, 1830, 2230	
					490		A	0000, 0400, 0800, 1200, 1600, 2200	
	Philippines	Davao	07° 04' N	125° 36' E	518	400	K	0140, 0540, 0940, 1340, 1740, 2140	
		Manila	14° 35' N	121° 03' E	518	400	J	0130, 0530, 0930, 1330, 1730, 2130	
		P Princesa	09° 44' N	118° 43' E	518	400	I	0120, 0520, 0920, 1320, 1720, 2120	
	Singapore	Singapore	01° 21' N	103° 59' E	518	400	C	0020, 0420, 0820, 1220, 1620, 2020	
	Taiwan	Kaohsiung	22° 29' N	120° 25' E	518	216	P	0230, 0630, 1030, 1430, 1830, 2230	
		Chilung	25° 09' N	121° 44' E	518	400	P	0230, 0630, 1030, 1430, 1830, 2230	
	Thailand	Bangkok	13° 43' N	100° 34' E	518	200	F	0050, 0450, 0850, 1250	
	United States	Guam	13° 29' N	144° 50' E	518	100	V	0330, 0730, 1130, 1530, 1930, 2330	
	Vietnam	Ho Chi Minh	10° 23' N	107° 08' E	518	400	X	0350, 0750, 1150, 1550, 1950, 2350	
		Haiphong	20° 44' N	106° 44' E	490		W	0340, 0740, 1140, 1540, 1940, 2340	
Danang		16° 05' N	108° 13' E	518	400	K	0140, 0540, 0940, 1340, 1740, 2140		
XII	Canada	Prince Rupert	54° 20' N	130° 20' W	518	300	D	0030, 0430, 0830, 1230, 1630, 2030	
		Tofino	48° 55' N	125° 35' W	518	300	H	0110, 0510, 0910, 1310, 1710, 2110	
	Ecuador	Ayora	00° 45' S	090° 19' W	518	400	L	0150, 0550, 0950, 1350, 1750, 2150	
					490		A	0000, 0400, 0800, 1200, 1600, 2000	
	United States	San Francisco	37° 55' N	122° 44' W	518	350	C	0020, 0420, 0820, 1220, 1620, 2020	
		Kodiak (EAST)	57° 46' N	152° 34' W	518	200	J	0130, 0530, 0930, 1330, 1730, 2130	
							X	0350, 0750, 1150, 1550, 1950, 2250	
		Kodiak (WEST)							
		Honolulu	21° 22' N	158° 09' W	518	350	O	0220, 0620, 1020, 1420, 1820, 2220	
		Cambria	35° 31' N	121° 03' W	518	350	Q	0240, 0640, 1040, 1440, 1840, 2240	
Astoria	46° 10' N	123° 49' W	518	216	W	0340, 0740, 1140, 1540, 1940, 2240			
XIII	Russia	Beringovskiy	63° 03' N	179° 20' E	518	400	E	0040, 0440, 0840, 1240, 1640, 2040	
		Kholmsk	47° 02' N	142° 03' E	518	300	B	0010, 0410, 0810, 1210, 1610, 2010	
		Magadan	59° 41' N	150° 09' E	518	120	D	0030, 0430, 0830, 1230, 1630, 2030	
		Okhotsk	59° 22' N	143° 12' E	518	300	G	0100, 0500, 0900, 1300, 1700, 2100	
		Petropavlovsk	53° 00' N	158° 40' E	518	300	C	0020, 0420, 0820, 1220, 1620, 2020	
		Provideniya	64° 40' N	173° 10' W	518	400	F	0050, 0450, 0850, 1250, 1650, 2050	
		Vladivostok	43° 23' N	131° 54' E	518	230	A	0000, 0400, 0800, 1200, 1600, 2000	
XIV	NIL								

(Continued on next page)

NAV area	Country	Station	Latitude	Longitude	Freq. (kHz)	Area (nm)	Station ID	Broadcast schedule (UTC)
XV	Chile	Antofagasta	23° 40' S	070° 25' W	518	300	A	0400, 1200, 2000
							H	0000, 0800, 1600
		Valparaiso	32° 48' S	071° 29' W	518	300	B	0410, 1210, 2010
							I	0010, 0810, 1610
		Talcahuano	36° 42' S	073° 06' W	518	300	C	0420, 1220, 2020
							J	0020, 0820, 1620
		Puerto Montt	41° 30' S	072° 58' W	518	300	D	0430, 1230, 2030
							K	0030, 0830, 1630
		Punta Arenas	53° 09' S	070° 58' W	518	300	E	0440, 1240, 2040
L	0040, 0840, 1640							
Isla d Pascua	27° 09' S	109° 25' W	518	300	F	0450, 1250, 2050		
					G	0050, 0850, 1650		
XVI	Ecuador	Guayaquil	02° 17' S	079° 52' W	518	400	M	0200, 0600, 1000, 1400, 1800, 2200
	Peru	Paita	05° 05' S	081° 07' W	518	200	S	0300, 0700, 1100, 1500, 1900, 2300
		Callao	12° 03' S	077° 09' W	518	200	U	0320, 0720, 1120, 1520, 1920, 2320
		Mollendo	17° 01' S	072° 01' W	518	200	W	0340, 0740, 1140, 1540, 1940, 2340
XVII	NIL							
XVIII* (IV)	Greenland	Uppernavik	72° 47' N	056° 07' W	518	400	I	0120, 0520, 0920, 1320, 1720, 2120
XIX* (I)	Norway	Bodo	67° 16' N	014° 23' E	518	450	B	0010, 0410, 0810, 1210, 1610, 2010
		Vardoe Radio	70° 22' N	031° 06' E	518	450	C	0020, 0420, 0820, 1220, 1620, 2020
		Svalbard	78° 04' N	013° 38' E	518	450	A	0000, 0400, 0800, 1200, 1600, 2000
XX* (I)	Russia	Arkhangelsk	64° 51' N	040° 17' E	518	300	L	0150, 0550, 0950, 1350, 1750, 2150
		Murmansk	68° 46' N	032° 58' E	518	300	K	0140, 0540, 0940, 1340, 1740, 2140
XXI* (XIII)	Russia	Tiksi	71° 38' N	128° 50' E	518	300	Q	0240, 0640, 1040, 1440, 1840, 2240

\*: This equipment can not set the NAV area numbers from XVIII to XXI. These are registered as the NAV area numbers in the parentheses in the above list (i.e. IV, I or XIII).

# Menu Tree

## NavNet menu tree

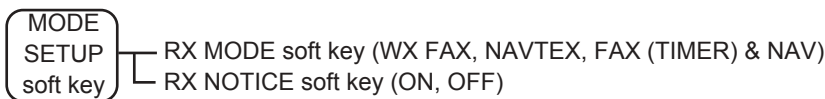
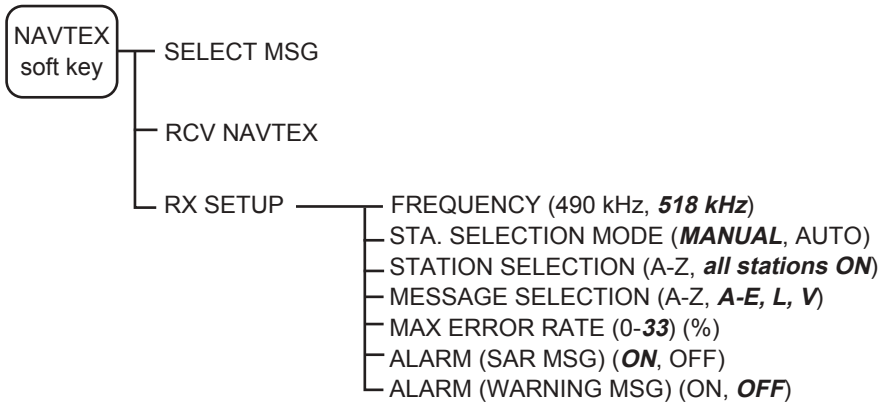
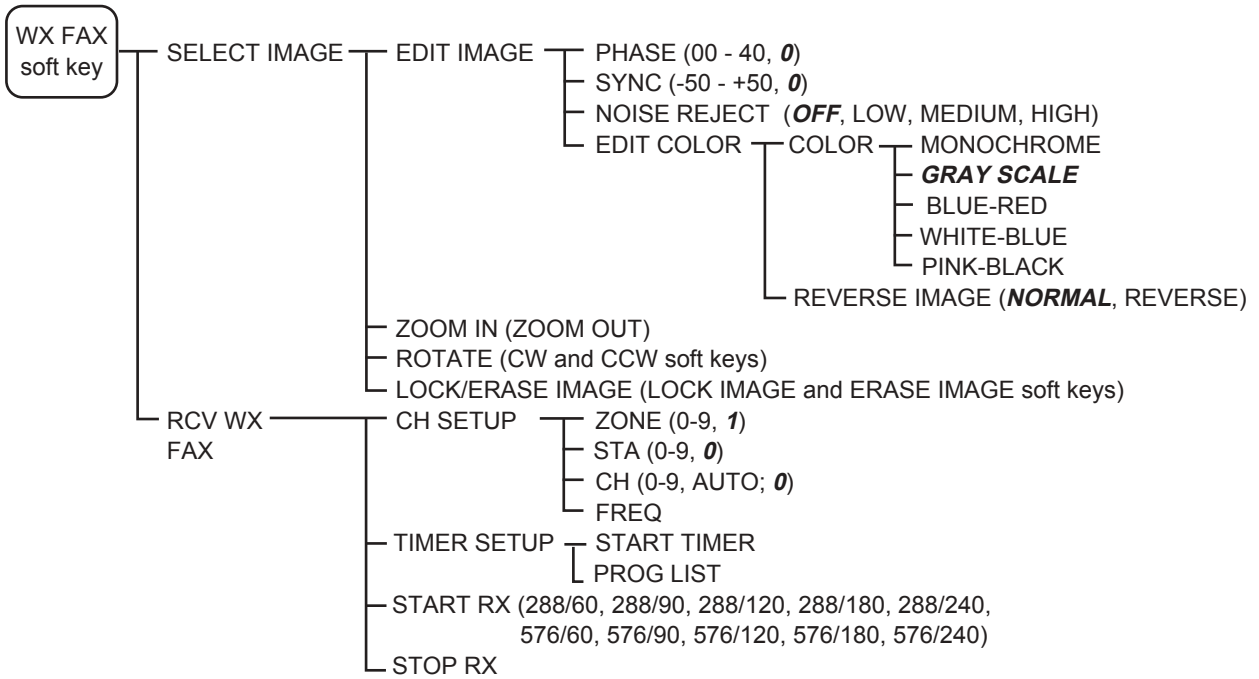

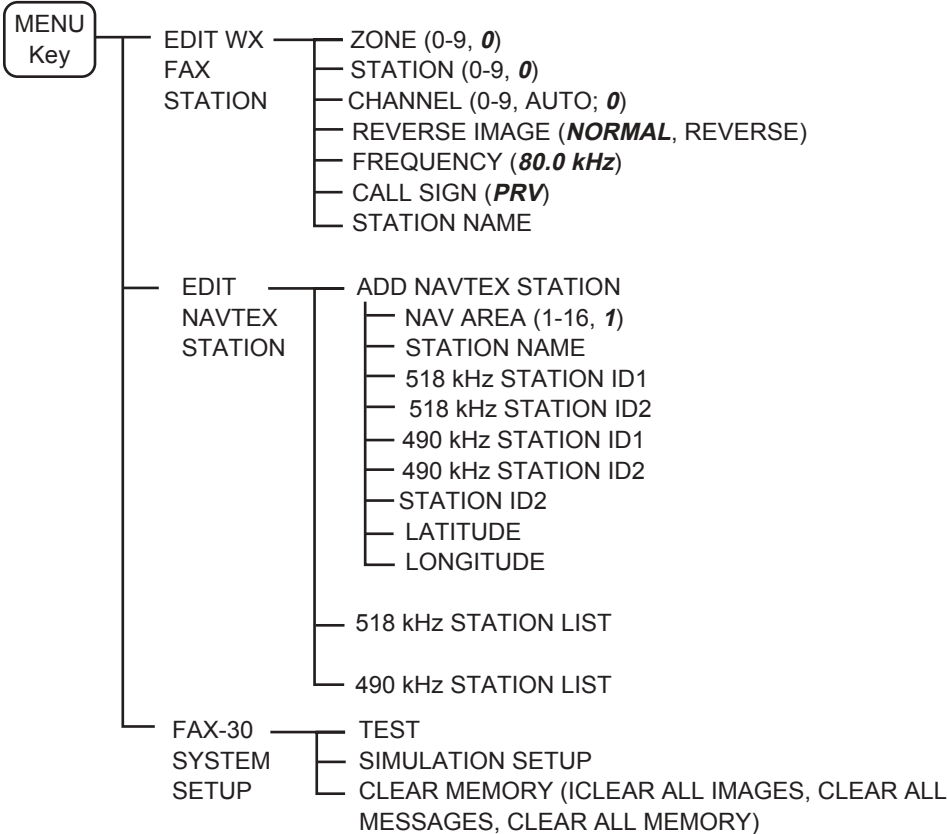

## PC, NavNet 3D menu tree

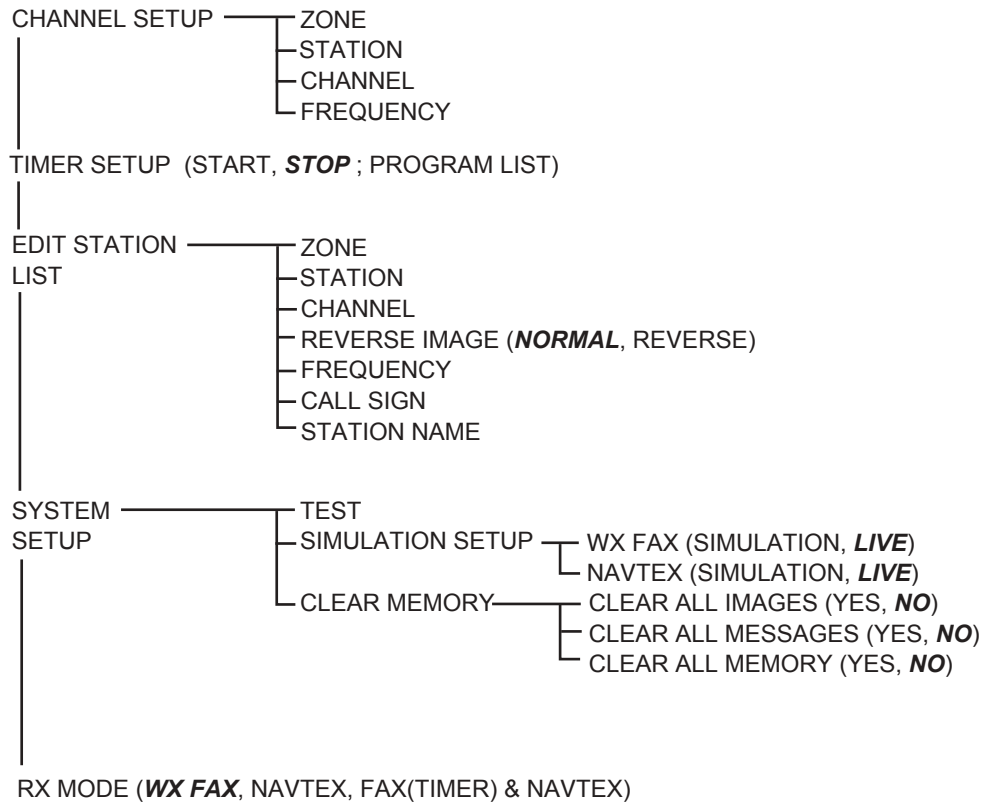

- RX SETUP
  - FREQUENCY (490 kHz, **518 kHz**)
  - STATION SELECTION MODE (**MANUAL**, AUTO)
  - STATION ID SELECTION (A-Z, **all stations ON**)
  - MESSAGE ID SELECTION (A-Z, **A-E, L, V**)
  - MAX. ERROR RATE (0-33%, **33**)

- EDIT STATION LIST
  - NAV AREA (I-XVI, **I**)
  - STATION NAME
  - 518kHz STATION ID1
  - 518kHz STATION ID2
  - 490kHz STATION ID1
  - 490kHz STATION ID2
  - LATITUDE
  - LONGITUDE
  - 490 kHz STATION LIST
  - 518 kHz STATION LIST

SYSTEM SETUP (Same items as on the facsimile menu.)

RX MODE (Same items as on the facsimile menu.)

**SPECIFICATIONS OF FACSIMILE RECEIVER  
FAX-30****1 GENERAL**

- |     |                    |                           |
|-----|--------------------|---------------------------|
| 1.1 | Frequency          |                           |
|     | FAX LF             | 80-160 kHz                |
|     | MF/HF              | 2-25 MHz                  |
|     | NAVTEX             | 490 kHz, 518 kHz          |
| 1.2 | Number of channels | 1000                      |
| 1.3 | Receiving system   | Double super heterodyne   |
| 1.4 | Class of emission  | FAX: F3C/J3C, NAVTEX: F1B |
| 1.5 | Network interface  | Ethernet 10 BASE-T TCP/IP |

**2 POWER SUPPLY**

- |     |           |                                     |
|-----|-----------|-------------------------------------|
| 2.1 | Main unit | 12-24 VDC (10.8-31.2 V) : 1.0-0.5 A |
|-----|-----------|-------------------------------------|

**3 ENVIRONMENTAL CONDITION**

- |     |                      |                      |
|-----|----------------------|----------------------|
| 3.1 | Ambient temperature  | -15°C to +55°C       |
| 3.2 | Relative humidity    | 95% or less at +40°C |
| 3.3 | Degree of protection |                      |
|     | Main unit            | IPX2                 |
|     | Antenna unit         | IPX6                 |
| 3.4 | Vibration            | IEC 60945            |

**4 UNIT COLOR**





- |     |              |              |
|-----|--------------|--------------|
| 4.1 | Main unit    | N3.0         |
| 4.2 | Antenna unit | N9.5 (white) |

PACKING LIST

08AV-X-9851 -6 1/1

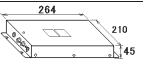
FAX-30-J/E-AN

A-1

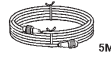
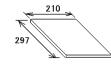
NAME	OUTLINE	DESCRIPTION/CODE No.	Q'TY
<b>ユニット UNIT</b> ファクシミリ受信装置 FACSIMILE RECEIVER		FAX-30 000-057-102-00	1
<b>予備品 SPARE PARTS</b>			
予備品 SPARE PARTS		SP08-01901 005-952-780-00	1
<b>工事材料 INSTALLATION MATERIALS</b>			
工事材料 INSTALLATION MATERIALS		CP08-01701 005-952-790-00	1
<b>工事材料 INSTALLATION MATERIALS</b>			
ケーブル組品MJ CABLE ASSY.		MJ-A3SPF0024-035C 000-157-943-10	1
ケーブル組品MJ CABLE ASSY.		MJ-A6SPF0014-050C 000-154-049-10	1
<b>図書 DOCUMENT</b>			
取扱説明書 OPERATOR'S MANUAL		OM*-62600-* 000-809-374-1* **	1

コード番号末尾の[\*]\*\*は、選択品の代表コードを表します。  
CODE NUMBER ENDING WITH "\*\*" INDICATES THE CODE NUMBER OF REPRESENTATIVE MATERIAL.

型式/コード番号が2段の場合、下段より上段に代わる過渡期品であり、どちらかが入っています。なお、品質は変わりません。  
TWO TYPES AND CODES MAY BE LISTED FOR AN ITEM. THE LOWER PRODUCT MAY BE SHIPPED IN PLACE OF THE UPPER PRODUCT. QUALITY IS THE SAME.  
(略図の寸法は、参考値です。DIMENSIONS IN DRAWING FOR REFERENCE ONLY.)





C6260-201-F

PACKING LIST

08AV-X-9852 -8 1/1

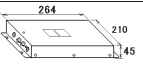
FAX-30-J/E-AP

A-2

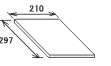
NAME	OUTLINE	DESCRIPTION/CODE No.	Q'TY
<b>ユニット UNIT</b> ファクシミリ受信装置 FACSIMILE RECEIVER		FAX-30 000-057-102-00	1
<b>予備品 SPARE PARTS</b>			
予備品 SPARE PARTS		SP08-01901 005-952-780-00	1
<b>工事材料 INSTALLATION MATERIALS</b>			
工事材料 INSTALLATION MATERIALS		CP08-01701 005-952-790-00	1
<b>工事材料 INSTALLATION MATERIALS</b>			
ケーブル組品MJ CABLE ASSY.		MJ-A3SPF0024-035C 000-157-943-10	1
ケーブル組品MJ CABLE ASSY.		MJ-A6SPF0017-050C 000-159-705-12	1
<b>図書 DOCUMENT</b>			
取扱説明書 OPERATOR'S MANUAL		OM*-62600-* 000-809-374-1* **	1

コード番号末尾の[\*]\*\*は、選択品の代表コードを表します。  
CODE NUMBER ENDING WITH "\*\*" INDICATES THE CODE NUMBER OF REPRESENTATIVE MATERIAL.

型式/コード番号が2段の場合、下段より上段に代わる過渡期品であり、どちらかが入っています。なお、品質は変わりません。  
TWO TYPES AND CODES MAY BE LISTED FOR AN ITEM. THE LOWER PRODUCT MAY BE SHIPPED IN PLACE OF THE UPPER PRODUCT. QUALITY IS THE SAME.  
(略図の寸法は、参考値です。DIMENSIONS IN DRAWING FOR REFERENCE ONLY.)





C6260-202-H

PACKING LIST

08AV-X-9853 -5 1/1

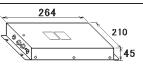
FAX-30-J/E-N

A-3

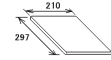
NAME	OUTLINE	DESCRIPTION/CODE No.	Q'TY
<b>ユニット UNIT</b> ファクシミリ受信装置 FACSIMILE RECEIVER		FAX-30 000-057-102-00	1
<b>予備品 SPARE PARTS</b>			
予備品 SPARE PARTS		SP08-01901 005-952-780-00	1
<b>工事材料 INSTALLATION MATERIALS</b>			
工事材料 INSTALLATION MATERIALS		CP08-01701 005-952-790-00	1
<b>工事材料 INSTALLATION MATERIALS</b>			
ケーブル組品MJ CABLE ASSY.		MJ-A3SPF0024-035C 000-157-943-10	1
<b>図書 DOCUMENT</b>			
取扱説明書 OPERATOR'S MANUAL		OM*-62600-* 000-809-374-1* **	1

コード番号末尾の[\*]\*\*は、選択品の代表コードを表します。  
CODE NUMBER ENDING WITH "\*\*" INDICATES THE CODE NUMBER OF REPRESENTATIVE MATERIAL.

型式/コード番号が2段の場合、下段より上段に代わる過渡期品であり、どちらかが入っています。なお、品質は変わりません。  
TWO TYPES AND CODES MAY BE LISTED FOR AN ITEM. THE LOWER PRODUCT MAY BE SHIPPED IN PLACE OF THE UPPER PRODUCT. QUALITY IS THE SAME.  
(略図の寸法は、参考値です。DIMENSIONS IN DRAWING FOR REFERENCE ONLY.)

C6260-203-E

FURUNO

CODE NO.	005-952-790-00	08AV-X-9401-0
TYPE	CP08-01701	1/1

番号 NO.	名称 NAME	略図 OUTLINE	型名/規格 DESCRIPTIONS	数量 Q'TY	用途/備考 REMARKS
1	+selfタッピング' 1ヶ SELF-TAPPING SCREW		5X20 SUS304 CODE NO. 000-162-568-10	4	

型式/コード番号が2段の場合、下段より上段に代わる過渡期品であり、どちらかが入っています。なお、品質は変わりません。  
TWO TYPES AND CODES MAY BE LISTED FOR AN ITEM. THE LOWER PRODUCT MAY BE SHIPPED IN PLACE OF THE UPPER PRODUCT. QUALITY IS THE SAME.  
(略図の寸法は、参考値です。DIMENSIONS IN DRAWING FOR REFERENCE ONLY.)

FURUNO ELECTRIC CO., LTD.

C6260-M01-A

**FURUNO**

CODE NO.	005-952-780-00	08AV-X-9301-2 1/1
TYPE	SP08-01901	BOX NO. P

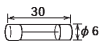
SHIP NO.	SPARE PARTS LIST FOR		U S E			SETS PER VESSEL	
	FAX-30						
ITEM NO.	NAME OF PART	OUTLINE	DRG. NO. OR TYPE NO.	QUANTITY			REMARKS/CODE NO.
				WORKING PER SET	PER VES	SPARE	
1	E1-X GLASS TUBE FUSE		FGB0-A 250V ZA PBF	1	1	2	000-155-829-10
MFR'S NAME	FURUNO ELECTRIC CO., LTD.		DRG. NO.	C6260-P01-C		1/1	

(略図の寸法は、参考値です。 DIMENSIONS IN DRAWING FOR REFERENCE ONLY.)

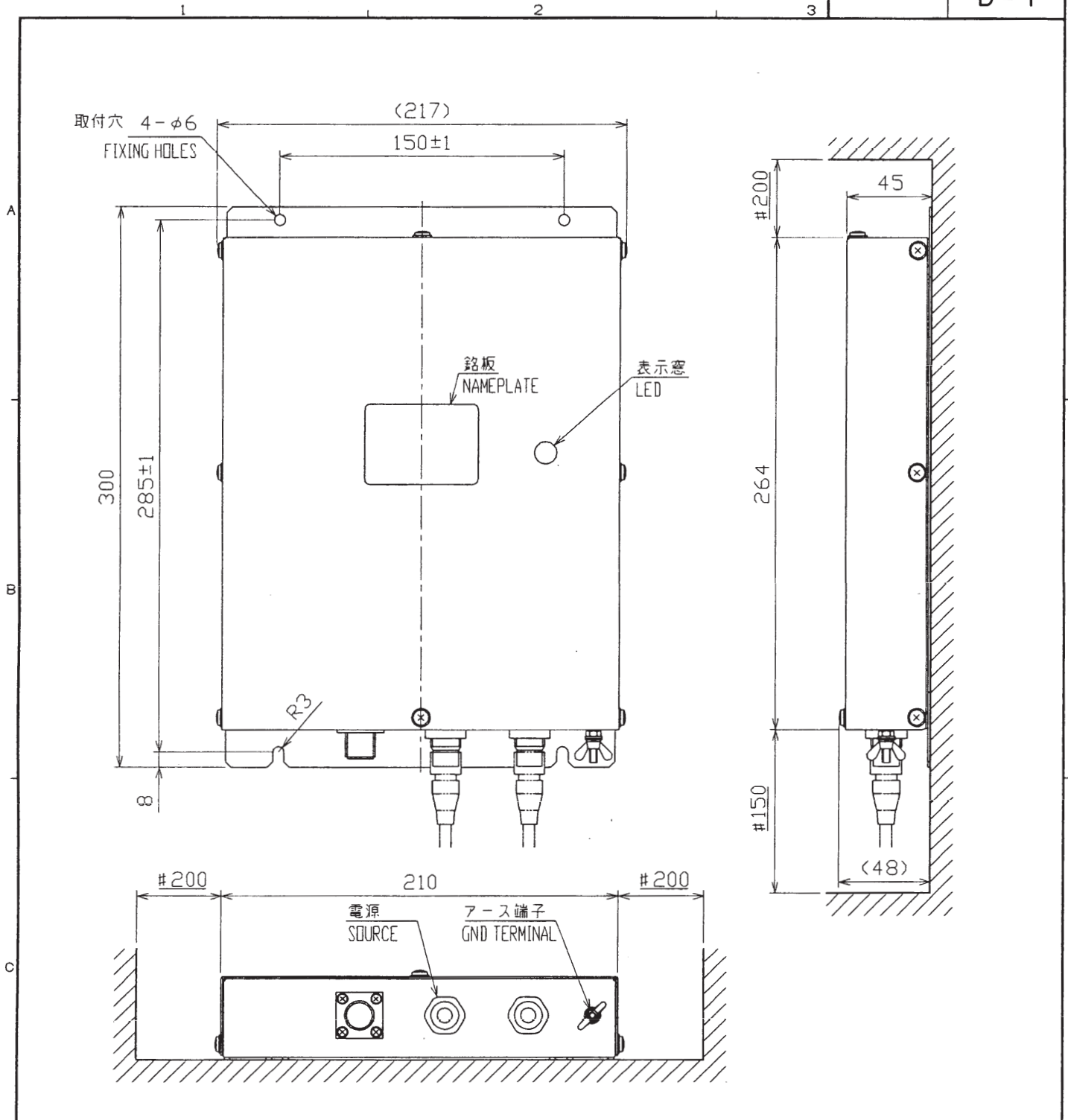

- 注 記 1) #印寸法は最小サービス空間寸法とする。  
 2) 指定外の寸法公差は表1による。  
 3) 取付用ネジは+トフスタツピンネジ呼び径5×20を使用。

- NOTE 1. #: RECOMMENDED SERVICE CLEARANCE.  
 2. TABLE 1 INDICATES TOLERANCE OF DIMENSIONS.  
 3. USE TAPPING SCREWS 5x20 FOR FIXING THE UNIT.

寸法区分 (mm) DIMENSION	公差 (mm) TOLERANCE
L ≤ 50	±1.5
50 < L ≤ 100	±2.5
100 < L ≤ 500	±3

表1 TABLE 1

DRAWN July 5 '02 T.YAMASAKI		TITLE FAX-30
CHECKED July 5 '02 Y.KI		名称 ファクシミリ受画装置
APPROVED July 5 '02 Y.KI		外寸図
SCALE 1/3 MASS 2.0 ±10% kg		NAME FACSIMILE RECEIVER UNIT
C6260-G01-A	08-022-100G-0	OUTLINE DRAWING

表 1 TABLE 1

寸法範囲 (mm) DIMENSIONS	公差(mm) TOLERANCE
$L \leq 50$	$\pm 1.5$
$50 < L \leq 100$	$\pm 2.5$
$100 < L \leq 500$	$\pm 3$

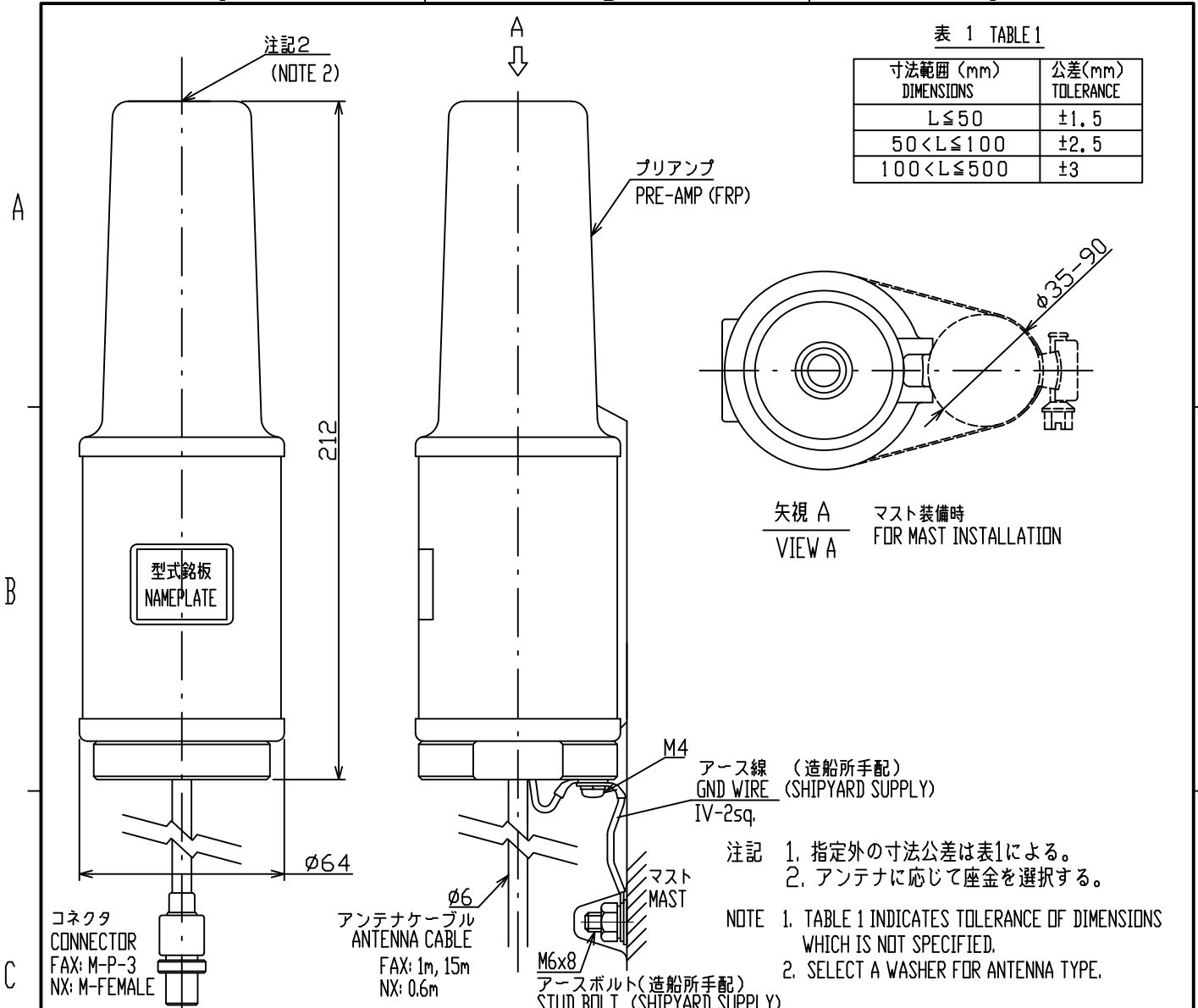

- 注記 1. 指定外の寸法公差は表1による。  
2. アンテナに応じて座金を選択する。
- NOTE 1. TABLE 1 INDICATES TOLERANCE OF DIMENSIONS WHICH IS NOT SPECIFIED.  
2. SELECT A WASHER FOR ANTENNA TYPE.

マストへの取付  
MAST MOUNTING



ホイップアンテナの場合  
FOR WHIP ANTENNA

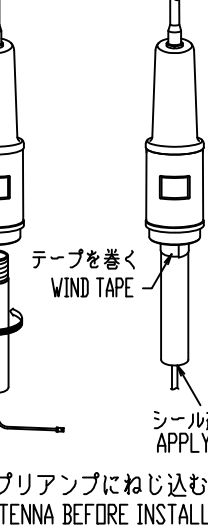

マスト装備  
FIXING TO MAST

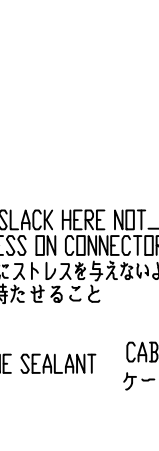

アンテナワイヤの場合  
FOR ANTENNA WIRE

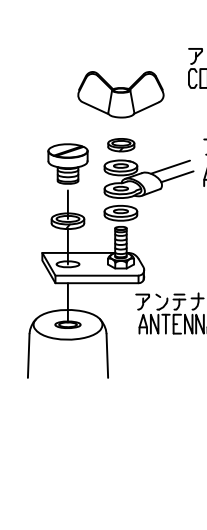

DRAWN	5/Mar/2020	T.YAMASAKI	TITLE	FAX-5, NX-5/6
CHECKED	5/Mar/2020	H.MAKI	名称	プリアンプ
APPROVED	6/Mar/2020	H.MAKI		外寸図
SCALE	1/2	MASS 0.6 ±10% kg	NAME	PRE-AMP UNIT
DWG.No.	C6244-003-Q			OUTLINE DRAWING

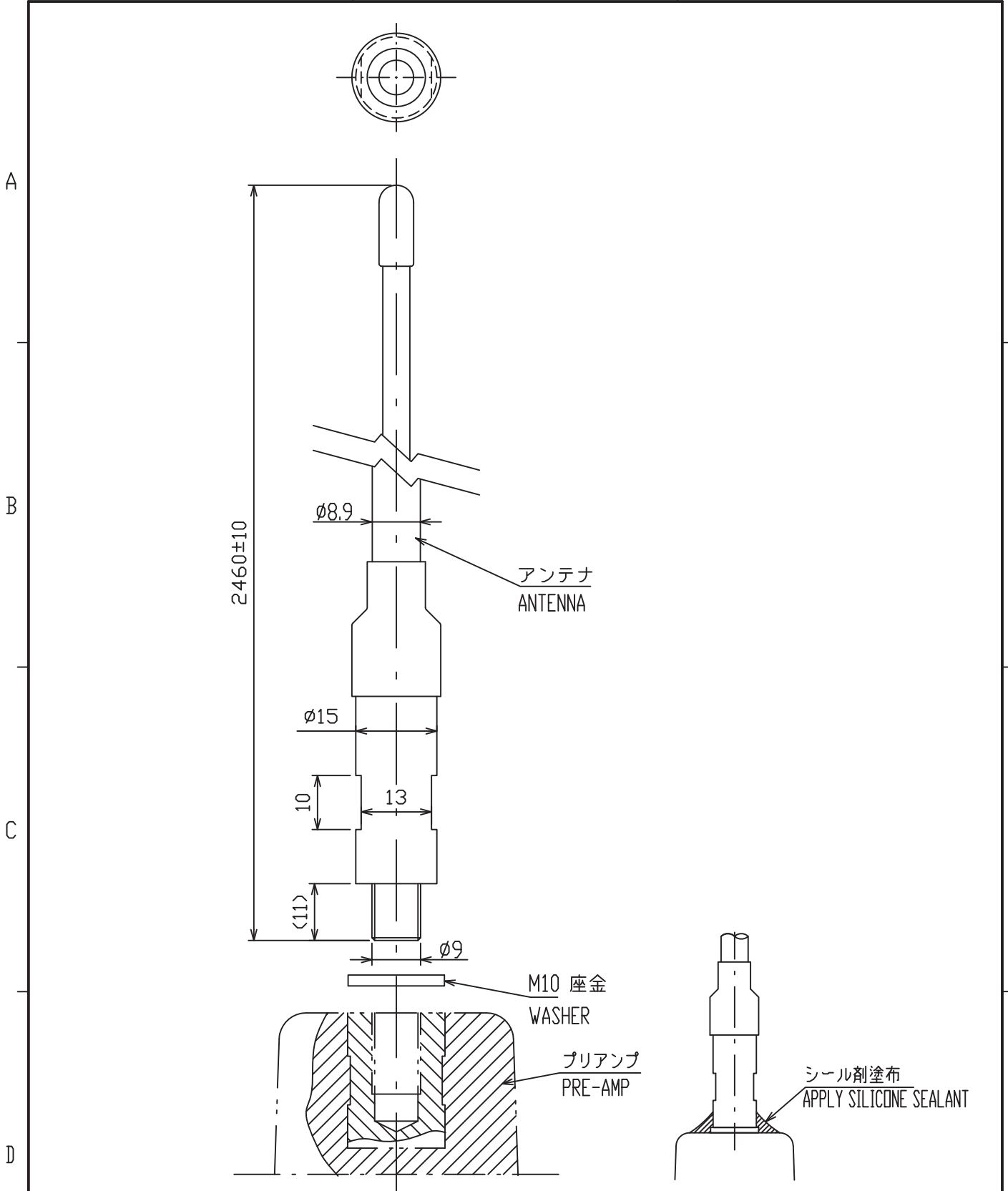

注記 締付けはトルクレンチを使用してください。(25.0±5% N・m)

NOTE USE A TORQUE WRENCH FOR FASTENING W/ 25.0±5% [N・m].

DRAWN	28/Jan/2014	T.YAMASAKI	TITLE	04S4176
CHECKED	28/Jan/2014	H.MAKI	名称	2.6m ホイップアンテナ
APPROVED	28/Jan/2014	H.MAKI	外寸図	
SCALE	1/1	MASS	0.5 ±10%	NAME
			kg	2.6m WHIP ANTENNA
DWG.No.	C4002-018- K		REF.No.	OUTLINE DRAWING

4

3

2

1

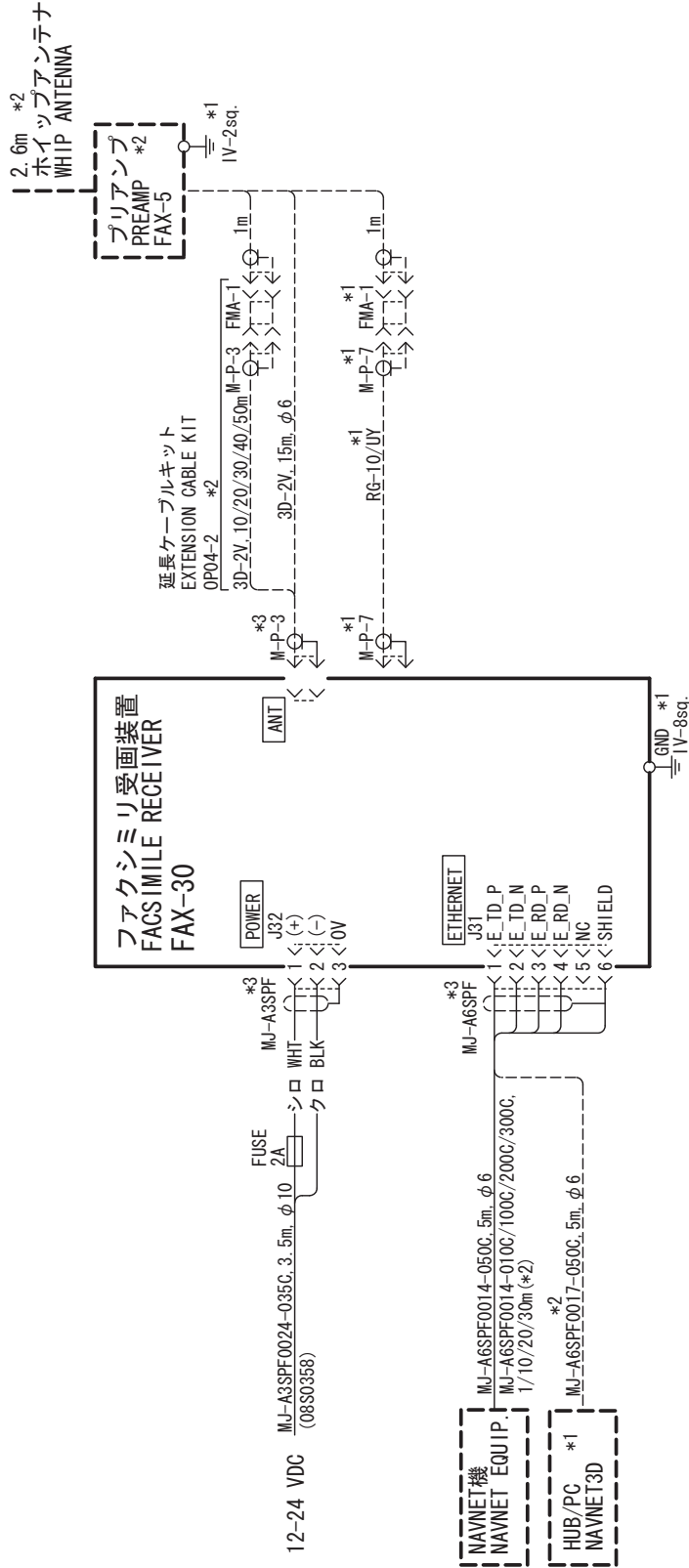

注記

- \*1) 造船所手配。
- \*2) オプション。
- \*3) 工場にて取付済み。

NOTE

- \*1. SHIPYARD SUPPLY.
- \*2. OPTION.
- \*3. FITTED AT FACTORY.

DRAWN	8/Nov/2012	T. YAMASAKI	TITLE	FAX-30
CHECKED	8/Nov/2012	H. MAKI	名称	ファクシミリ受信装置
APPROVED	9/Nov/2012	Y. NISHIYAMA	相互結線図	
SCALE	MASS		NAME	FACSIMILE RECEIVER
DWG. No.	C6260-C01-G		REF. No.	08-001-3146-3
			INTERCONNECTION DIAGRAM	

# INDEX

## A

- Automatic fax receiving
  - starting (NavNet) .....2-1
  - starting (NavNet 3D, PC).....3-1
  - stopping (NavNet) .....2-4
  - stopping (NavNet 3D, PC).....3-1

## C

- CCW soft key.....2-16
- CH SETUP soft key .....2-2
- CHANNEL soft key .....2-3
- CLEAR ALL soft key .....2-11
- Clearing data
  - NavNet.....6-5
  - (NavNet 3D, PC).....6-6
- COLOR soft key .....2-15
- Controls (NavNet).....1-1
- CW soft key .....2-16

## D

- Diagnostics
  - NavNet.....6-3
  - (NavNet 3D, PC).....6-4
- DISP key.....1-3

## E

- EDIT COLOR soft key .....2-15
- ERASE IMAGE soft key .....2-16
- Erasing fax images
  - NavNet.....2-16
  - NavNet 3D, PC.....3-9
  - preventing erasure of (NavNet).....2-17
  - preventing erasure of (PC).....3-10

## F

- Fax channel addition
  - NavNet.....2-18
  - (NavNet 3D, PC).....3-11
- Fax images
  - displaying (NavNet) .....2-12
  - displaying (PC) .....3-5
  - erasing (NavNet) .....2-16
  - erasing ((NavNet 3D,PC) .....3-9
  - erasure, preventing of (NavNet).....2-17
  - erasure, preventin of (NavNet 3D, PC) 3-10
  - processing (NavNet).....2-13

- processing (PC) .....3-5
- saving (NavNet 3D, PC) .....3-9

- FAX mode (NavNet).....1-3
- Fax station list .....AP-2
- Fax station map.....AP-1

## I

- Image color
  - NavNet .....2-15
  - NavNet 3D, PC .....3-8
- Image format
  - NavNet .....2-15
  - NavNet 3D, PC .....3-8

## L

- LOCK IMAGE soft key .....2-17
- LOCK/ERASE soft key.....2-16
- Logout .....1-8

## M

- Maintenance.....6-1
- Manual fax receiving (NavNet)
  - starting .....2-5
  - stopping.....2-6
- Menu tree .....AP-9

## N

- Navtex messages
  - categories.....4-1
  - displaying (NavNet).....4-6
  - displaying (NavNet 3D, PC).....5-3
  - previewing (NavNet) .....4-5
- Navtex setup
  - NavNet .....4-2
  - (NavNet 3D, PC).....5-2
- Navtex stations
  - list of.....AP-5
  - map of .....AP-4
- Navtex stations
  - addition (NavNet) .....4-9
  - addition (NavNet 3D, PC) .....5-5
  - editing (NavNet 3D, PC).....4-9
  - editing (NavNet 3D, PC) .....5-6
  - erasing (NavNet 3D, PC PC).....5-7
  - list (NavNet) .....4-8
  - list NavNet 3D, PC (PC) .....5-4
- NOISE REJECT soft key .....2-14

## INDEX

Noise rejection	
NavNet.....	2-14
NavNet 3D, PC.....	3-7

### **P**

Phase	
NavNet.....	2-13
NavNet 3D, PC.....	3-6
PHASE soft key.....	2-13
PROG LIST soft key.....	2-11

### **R**

RCV NAVTEX soft key.....	4-5
Receive mode	
NavNet.....	1-4
NavNet 3D, PC.....	1-8
Receive notification (NavNet).....	1-5
REV IMAGE soft key.....	2-15
ROTATE soft key.....	2-16
Rotating fax images	
NavNet.....	2-16
NavNet 3D, PC.....	3-9
RX MODE soft key.....	1-4
RX NOTICE soft key.....	1-5

### **S**

Saving fax images (PC).....	3-9
SELECT IMAGE soft key.....	2-12
Simulation mode	
NavNet.....	6-8
NavNet 3D, PC.....	6-9
Standby display	
NavNet 3D, PC.....	1-6
STATION soft key.....	2-2
STOP RX soft key.....	2-4
Sync	
NavNet.....	2-14
NavNet 3D, PC.....	3-7
SYNC soft key.....	2-14
System configuration.....	ix

### **T**

Timer operation	
clearing all programs (NavNet).....	2-11
clearing all programs (NavNet 3D, PC) ..	3-4
setting (NavNet).....	2-7
setting (PC).....	3-2
turning on/off all program (NavNet) .....	2-11
turning on/off all programs	
(NavNet 3D, PC).....	3-4
turning on/off specific	
programs (NavNet).....	2-11
turning on/off specific programs	
(NavNet 3D, PC).....	3-4
TIMER SETUP soft key.....	2-11
TIMER soft key.....	2-7

### **Z**

ZONE soft key.....	2-2
Zoom	
NavNet.....	2-16
NavNet 3D, PC.....	3-9
ZOOM IN soft key.....	2-16
ZOOM OUT soft key.....	2-16

# FURUNO Worldwide Warranty for Pleasure Boats (Except North America)

This warranty is valid for products manufactured by Furuno Electric Co. (hereafter FURUNO) and installed on a pleasure boat. Any web based purchases that are imported into other countries by anyone other than a FURUNO certified dealer may not comply with local standards. FURUNO strongly recommends against importing these products from international websites as the imported product may not work correctly and may interfere with other electronic devices. The imported product may also be in breach of the local laws and mandated technical requirements. Products imported into other countries as described previously shall not be eligible for local warranty service.

For products purchased outside of your country please contact the national distributor of Furuno products in the country where purchased.

This warranty is in addition to the customer's statutory legal rights.

## 1. Terms and Conditions of Warranty

FURUNO guarantees that each new FURUNO product is the result of quality materials and workmanship. The warranty is valid for a period of 2 years (24 months) from the date of the invoice, or the date of commissioning of the product by the installing certified dealer.

## 2. FURUNO Standard Warranty

The FURUNO standard warranty covers spare parts and labour costs associated with a warranty claim, provided that the product is returned to a FURUNO national distributor by prepaid carrier.

The FURUNO standard warranty includes:

- Repair at a FURUNO national distributor
- All spare parts for the repair
- Cost for economical shipment to customer

## 3. FURUNO Onboard Warranty

If the product was installed/commissioned and registered by a certified FURUNO dealer, the customer has the right to the onboard warranty.

The FURUNO onboard warranty includes

- Free shipping of the necessary parts
- Labour: Normal working hours only
- Travel time: Up to a maximum of two (2) hours
- Travel distance: Up to a maximum of one hundred and sixty (160) KM by car for the complete journey

## 4. Warranty Registration

For the Standard Warranty - presentation of product with serial number (8 digits serial number, 1234-5678) is sufficient. Otherwise, the invoice with serial number, name and stamp of the dealer and date of purchase is shown.

For the Onboard Warranty your FURUNO certified dealer will take care of all registrations.

## 5. Warranty Claims

For the Standard Warranty - simply send the defective product together with the invoice to a FURUNO national distributor. For the Onboard Warranty – contact a FURUNO national distributor or a certified dealer. Give the product's serial number and describe the problem as accurately as possible.

Warranty repairs carried out by companies/persons other than a FURUNO national distributor or a certified dealer is not covered by this warranty.

## 6. Warranty Limitations

When a claim is made, FURUNO has a right to choose whether to repair the product or replace it.

The FURUNO warranty is only valid if the product was correctly installed and used. Therefore, it is necessary for the customer to comply with the instructions in the handbook. Problems which result from not complying with the instruction manual are not covered by the warranty.

FURUNO is not liable for any damage caused to the vessel by using a FURUNO product.

The following are excluded from this warranty:

- a. Second-hand product
- b. Underwater unit such as transducer and hull unit
- c. Routine maintenance, alignment and calibration services.
- d. Replacement of consumable parts such as fuses, lamps, recording papers, drive belts, cables, protective covers and batteries.
- e. Magnetron and MIC with more than 1000 transmitting hours or older than 12 months, whichever comes first.
- f. Costs associated with the replacement of a transducer (e.g. Crane, docking or diver etc.).
- g. Sea trial, test and evaluation or other demonstrations.
- h. Products repaired or altered by anyone other than the FURUNO national distributor or an authorized dealer.
- i. Products on which the serial number is altered, defaced or removed.
- j. Problems resulting from an accident, negligence, misuse, improper installation, vandalism or water penetration.
- k. Damage resulting from a force majeure or other natural catastrophe or calamity.
- l. Damage from shipping or transit.
- m. Software updates, except when deemed necessary and warrantable by FURUNO.
- n. Overtime, extra labour outside of normal hours such as weekend/holiday, and travel costs above the 160 KM allowance
- o. Operator familiarization and orientation.

FURUNO Electric Company, March 1, 2011

## FURUNO Warranty for North America

FURUNO U.S.A., Limited Warranty provides a twenty-four (24) months LABOR and twenty-four (24) months PARTS warranty on products from the date of installation or purchase by the original owner. Products or components that are represented as being waterproof are guaranteed to be waterproof only for, and within the limits, of the warranty period stated above. The warranty start date may not exceed eighteen (18) months from the original date of purchase by dealer from Furuno USA and applies to new equipment installed and operated in accordance with Furuno USA's published instructions.

Magnetrons and Microwave devices will be warranted for a period of 12 months from date of original equipment installation.

Furuno U.S.A., Inc. warrants each new product to be of sound material and workmanship and through its authorized dealer will exchange any parts proven to be defective in material or workmanship under normal use at no charge for a period of 24 months from the date of installation or purchase.

Furuno U.S.A., Inc., through an authorized Furuno dealer will provide labor at no cost to replace defective parts, exclusive of routine maintenance or normal adjustments, for a period of 24 months from installation date provided the work is done by Furuno U.S.A., Inc. or an AUTHORIZED Furuno dealer during normal shop hours and within a radius of 50 miles of the shop location.

A suitable proof of purchase showing date of purchase, or installation certification must be available to Furuno U.S.A., Inc., or its authorized dealer at the time of request for warranty service.

This warranty is valid for installation of products manufactured by Furuno Electric Co. (hereafter FURUNO). Any purchases from brick and mortar or web-based resellers that are imported into other countries by anyone other than a FURUNO certified dealer, agent or subsidiary may not comply with local standards. FURUNO strongly recommends against importing these products from international websites or other resellers, as the imported product may not work correctly and may interfere with other electronic devices. The imported product may also be in breach of the local laws and mandated technical requirements. Products imported into other countries, as described previously, shall not be eligible for local warranty service.

For products purchased outside of your country please contact the national distributor of Furuno products in the country where purchased.

### WARRANTY REGISTRATION AND INFORMATION

To register your product for warranty, as well as see the complete warranty guidelines and limitations, please visit [www.furunousa.com](http://www.furunousa.com) and click on "Support". In order to expedite repairs, warranty service on Furuno equipment is provided through its authorized dealer network. If this is not possible or practical, please contact Furuno U.S.A., Inc. to arrange warranty service.

FURUNO U.S.A., INC.  
**Attention: Service Coordinator**  
4400 N.W. Pacific Rim Boulevard  
Camas, WA 98607-9408  
Telephone: (360) 834-9300  
FAX: (360) 834-9400

Furuno U.S.A., Inc. is proud to supply you with the highest quality in Marine Electronics. We know you had several choices when making your selection of equipment, and from everyone at Furuno we thank you. Furuno takes great pride in customer service.

## Declaration of Conformity

[FAX-30]

Bulgarian (BG)	С настоящото Furuno Electric Co., Ltd. декларира, че гореспоменат тип радиосъоръжение е в съответствие с Директива 2014/53/ЕС, СИ 2017/1206. Цялостният текст на ЕС/УК декларацията за съответствие може да се намери на следния интернет адрес:
Spanish (ES)	Por la presente, Furuno Electric Co., Ltd. declara que el tipo de equipo radioeléctrico arriba mencionado es conforme con la Directiva 2014/53/UE, SI 2017/1206. El texto completo de la declaración de conformidad de la EU/UK está disponible en la siguiente dirección Internet:
Czech (CS)	Tímto Furuno Electric Co., Ltd. prohlašuje, že výše zmíněné typ rádiového zařízení je v souladu se směrnicí 2014/53/EU, SI 2017/1206. Úplné znění EU/SK prohlášení o shodě je k dispozici na této internetové adrese:
Danish (DA)	Hermed erklærer Furuno Electric Co., Ltd., at ovennævnte radioudstyr er i overensstemmelse med direktiv 2014/53/EU, SI 2017/1206. EU/UK-overensstemmelseserklæringens fulde tekst kan findes på følgende internetadresse:
German (DE)	Hiermit erkläre die Furuno Electric Co., Ltd., dass der oben genannte Funkanlagentyp der Richtlinie 2014/53/EU, SI 2017/1206 entspricht. Der vollständige Text der EU/UK-Konformitätserklärung ist unter der folgenden Internetadresse verfügbar:
Estonian (ET)	Käesolevaga deklareerib Furuno Electric Co., Ltd., et ülalmainitud raadioseadme tüüp vastab direktiivi 2014/53/EL, SI 2017/1206 nõuetele. EL/GB vastavusdeklaratsiooni täielik tekst on kättesaadav järgmisel internetiaadressil:
Greek (EL)	Με την παρούσα η Furuno Electric Co., Ltd., δηλώνει ότι ο προαναφερθέντας ραδιοεξοπλισμός πληροί την οδηγία 2014/53/ΕΕ, SI 2017/1206. Το πλήρες κείμενο της δήλωσης συμμόρφωσης ΕΕ/UK διατίθεται στην ακόλουθη ιστοσελίδα στο διαδίκτυο:
English (EN)	Hereby, Furuno Electric Co., Ltd. declares that the above-mentioned radio equipment type is in compliance with Directive 2014/53/EU, SI 2017/1206. The full text of the EU/UK declaration of conformity is available at the following internet address:
French (FR)	Le soussigné, Furuno Electric Co., Ltd., déclare que l'équipement radioélectrique du type mentionné ci-dessus est conforme à la directive 2014/53/UE, SI 2017/1206. Le texte complet de la déclaration UE/RU de conformité est disponible à l'adresse internet suivante:
Croatian (HR)	Furuno Electric Co., Ltd. ovime izjavljuje da je gore rečeno radijska oprema tipa u skladu s Direktivom 2014/53/EU, SI 2017/1206. Cjeloviti tekst EU/UK izjave o sukladnosti dostupan je na sljedećoj internetskoj adresi:
Italian (IT)	Il fabbricante, Furuno Electric Co., Ltd., dichiara che il tipo di apparecchiatura radio menzionato sopra è conforme alla direttiva 2014/53/UE, SI 2017/1206. Il testo completo della dichiarazione di conformità UE/RU è disponibile al seguente indirizzo Internet:
Latvian (LV)	Ar šo Furuno Electric Co., Ltd. deklarē, ka augstāk minēts radioiekārta atbilst Direktīvai 2014/53/ES, SI 2017/1206. Pilns ES/AK atbilstības deklarācijas teksts ir pieejams šādā interneta vietnē:
Lithuanian (LT)	Aš, Furuno Electric Co., Ltd., patvirtinu, kad pirmiau minėta radijo įrenginių tipas atitinka Direktyvą 2014/53/ES, SI 2017/1206. Visas ES/JK atitikties deklaracijos tekstas prieinamas šiuo interneto adresu:
Hungarian (HU)	Furuno Electric Co., Ltd. igazolja, hogy fent említett típusú rádióberendezés megfelel a 2014/53/EU, SI 2017/1206 irányelvnek. Az EU/EK-megfelelőségi nyilatkozat teljes szövege elérhető a következő internetes címen:
Maltese (MT)	B'dan, Furuno Electric Co., Ltd., niddikjara li msemmija hawn fuq-tip ta' tagħmir tar-radju huwa konformi mad-Direttiva 2014/53/UE, SI 2017/1206. It-test kollu tad-dikjarazzjoni ta' konformità tal-UE/RU huwa disponibbli f'dan l-indirizz tal-Internet li ġej:
Dutch (NL)	Hierbij verklaar ik, Furuno Electric Co., Ltd., dat het hierboven genoemde type radioapparatuur conform is met Richtlijn 2014/53/EU, SI 2017/1206. De volledige tekst van de EU/VK-conformiteitsverklaring kan worden geraadpleegd op het volgende internetadres:
Polish (PL)	Furuno Electric Co., Ltd. niniejszym oświadcza, że wyżej wymieniony typ urządzenia radiowego jest zgodny z dyrektywą 2014/53/UE, SI 2017/1206. Pełny tekst deklaracji zgodności UE/UK jest dostępny pod następującym adresem internetowym:
Portuguese (PT)	O(a) abaixo assinado(a) Furuno Electric Co., Ltd. declara que o mencionado acima tipo de equipamento de rádio está em conformidade com a Diretiva 2014/53/UE, SI 2017/1206. O texto integral da declaração de conformidade da EU/UK está disponível no seguinte endereço de Internet:
Romanian (RO)	Prin prezenta, Furuno Electric Co., Ltd. declară că echipamentul radio menționat mai sus este în conformitate cu Directiva 2014/53/UE, SI 2017/1206. Textul integral al declarației de conformitate UE/RU este disponibil la următoarea adresă internet:
Slovak (SK)	Furuno Electric Co., Ltd. týmto vyhlasuje, že vyššie spomínané rádiové zariadenie typu je v súlade so smernicou 2014/53/EÚ, SI 2017/1206. Úplné EÚ/SK vyhlásenie o zhode je k dispozícii na tejto internetovej adrese:
Slovenian (SL)	Furuno Electric Co., Ltd. potrjuje, da je zgoraj omenjeno tip radijske opreme skladen z Direktivo 2014/53/EU, SI 2017/1206. Celotno besedilo izjave EU/ZK o skladnosti je na voljo na naslednjem spletnem naslovu:
Finnish (FI)	Furuno Electric Co., Ltd. vakuuttaa, että yllä mainittu radiolaitetyyppi on direktiivin 2014/53/EU, SI 2017/1206 mukainen. EU/UK-vaatimustenmukaisuusvakuutuksen täysimittainen teksti on saatavilla seuraavassa internetosoitteessa:
Swedish (SV)	Härmed försäkrar Furuno Electric Co., Ltd. att ovan nämnda typ av radioutrustning överensstämmer med direktiv 2014/53/EU, SI 2017/1206. Den fullständiga texten till EU/Storbritannien-försäkran om överensstämmelse finns på följande webbadress:

### Online Resource

[http://www.furuno.com/en/support/red\\_doc](http://www.furuno.com/en/support/red_doc)

### Notice for radiated immunity

**The test for the radiated immunity is performed up to 2.7 GHz only without the special condition of spot frequency being applied. There is a chance that this equipment may interfere with allocated services in the frequency range of 2.7 GHz to 6 GHz, particularly in harbors, rivers, lake banks, etc.**

## PSTI Statement of Compliance

We **FURUNO ELECTRIC CO., LTD.**

(Name of manufacturer of the product)

9-52 Ashihara-Cho, Nishinomiya City, 662-8580, Hyogo, Japan

(Address of manufacturer of the product)

declare under our sole responsibility that the product

**FACSIMILE RECEIVER,  
FAX-30**

(Product type, batch)

**April / 30 / 2029**

(Support period for the product)

[https://www.furuno.co.jp/en/csr/sociality/customer/product\\_security.html](https://www.furuno.co.jp/en/csr/sociality/customer/product_security.html)

(Weblink for latest information and contact to report to the manufacturer security issues)

to which this declaration relates conforms to the following standard(s) or other normative document(s)

Product Security and Telecommunications Infrastructure Act 2022

Product Security and Telecommunications Infrastructure (Security Requirements for  
Relevant Connectable Products) Regulations 2023 Schedule 1

On behalf of Furuno Electric Co., Ltd.

Nishinomiya City, Japan  
24 April 2024

(Place and date of issue)

Akihiko Kanechika  
Department General Manager  
Quality Assurance Department

(Signature, name and function of the signatory)

