

FURUNO

OPERATOR'S MANUAL

AUTOPILOT

Model **NAVpilot-1000**

FURUNO ELECTRIC CO., LTD.

9-52 Ashihara-cho,
Nishinomiya, 662-8580, JAPAN

• FURUNO Authorized Distributor/Dealer

All rights reserved. Printed in Japan

Pub. No. OME-72890-B1

(SEHA) NAVpilot-1000

A : JAN. 2024

B1 : APR. 07, 2025



00019901812

IMPORTANT NOTICES

General

- This manual has been authored with simplified grammar, to meet the needs of international users.
- The operator of this equipment must read and follow the descriptions in this manual. Wrong operation or maintenance can void the warranty or cause injury.
- Do not copy any part of this manual without written permission from FURUNO.
- If this manual is lost or worn, contact your dealer about replacement.
- The contents of this manual and equipment specifications can change without notice.
- The example screens (or illustrations) shown in this manual can be different from the screens you see on your display. The screens you see depend on your system configuration and equipment settings.
- Save this manual for future reference.
- Any modification of the equipment (including software) by persons not authorized by FURUNO will void the warranty.
- The following concern acts as our importer in Europe, as defined in DECISION No 768/2008/EC.
 - Name: FURUNO EUROPE B.V.
 - Address: Ridderhaven 19B, 2984 BT Ridderkerk, The Netherlands
- The following concern acts as our importer in UK, as defined in SI 2016/1025 as amended SI 2019/470.
 - Name: FURUNO (UK) LTD.
 - Address: West Building Penner Road Havant Hampshire PO9 1QY, U.K.
- Operation of the vessel is solely responsibility of the customer. FURUNO will not be not responsible for any damage associated with misuse of this equipment.
- All brand and product names, trademarks, registered trademarks, and service marks belong to their respective holders.

How to discard this product

Discard this product according to local regulations for the disposal of industrial waste. For disposal in the USA, see the homepage of the Electronics Industries Alliance (<http://www.eiae.org/>) for the correct method of disposal.

How to discard a used battery

Some FURUNO products have a battery(ies). To see if your product has a battery, see the chapter on Maintenance. If a battery is used, tape + and - terminals of the battery before disposal to prevent fire, heat generation caused by short circuit.

In the European Union

The crossed-out trash can symbol indicates that all types of batteries must not be discarded in standard trash, or at a trash site. Take the used batteries to a battery collection site according to your national legislation and the Batteries Directive 2006/66/EU.

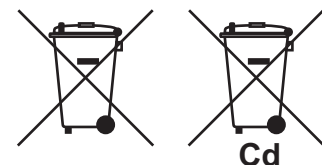

In the USA

The Mobius loop symbol (three chasing arrows) indicates that Ni-Cd and lead-acid rechargeable batteries must be recycled. Take the used batteries to a battery collection site according to local laws.

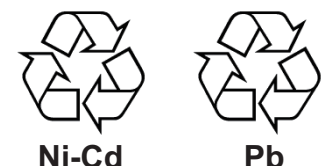



In the other countries

There are no international standards for the battery recycle symbol. The number of symbols can increase when the other countries make their own recycle symbols in the future.













SAFETY INSTRUCTIONS

Follow the safety instructions listed below and throughout this manual to prevent damage to your equipment or vessel and to prevent harm to the operator or other personnel on-board. The results of failing to follow the instructions and guidelines outlined herein are listed below.

 WARNING	Indicates a condition that can cause death or serious injury if not avoided.
 CAUTION	Indicates a condition that can cause minor or moderate injury if not avoided.

 Warning, Caution	 Prohibitive Action	 Mandatory Action
--	--	--

 WARNING	
	Do not open the equipment unless you are well familiar with electrical circuits. Only qualified personnel should work inside the equipment.
	Do not set the course changing speed too high. The boat will be turned too sharply at the course change, which could create a very dangerous situation.
	Do not use the autopilot in the following situations: <ul style="list-style-type: none"> - Speed 40 knots or higher - Navigating in a narrow channel - Entering or exiting a harbor - Area of heavy marine traffic - Cruising where the field of view is poor due to narrow visibility, fog, mist, or rain - Vessel is stopped
	Do not use the SIMULATION mode on the boat. The rudder may move suddenly. This is a special-purpose mode for technicians.
	Observe the following cautions when using the autopilot: <ul style="list-style-type: none"> - Maintain a vigilant watch - Watch for drifting of vessel

 WARNING	
	In an emergency, manually steer the vessel. The autopilot cannot avoid vessels, etc. automatically.
	Use the correct fuse. Use of a wrong fuse can cause fire or damage the equipment.
	Before starting or resuming auto steering, confirm that the actual heading matches the heading shown on this autopilot. If the displayed heading is not the same as the actual heading, the vessel may be steered in an unexpected direction, which could result in an accident such as collision.
	The processor unit must be connected to the power supply through a breaker (local supply). The breaker must be installed at a location that is easy to operate in an emergency. If the rudder is unintentionally moved or auto steering cannot be canceled, do as follows to stop the autopilot. <ul style="list-style-type: none"> • For analog steering system: Use the steering control changeover feature of the steering system to stop the auto steering, then turn the breaker off. • For solenoid steering system: Turn the breaker off.

WARNING

-  **Install a control unit equipped with the STBY key, or an “auto steering cancel button” (local supply) at the helm and all steering stations, to disable rudder control by the autopilot in an emergency.**

An accident may result if the auto steering cannot be canceled immediately. To enable auto steering cancellation from an auto steering cancel button, set [In Port 1] (or [In Port 2], [In Port 3], [In Port 4]) to [Go STBY] on the [Universal Port] menu. See the installation manual.

CAUTION

-  **In case of power failure, turn off the autopilot or manually steer the vessel.**

Leaving the equipment in the AUTO or NAV mode during power failure will cause wear on the rudder mechanism.

-  **Do not apply force excessive force or shock to the LCD panel.**

Force or shock can damaged the LCD or cause equipment failure

-  **Do not use high-pressure cleaners to clean this equipment.**

This equipment has the waterproof rating outlined in the specifications, at the back of this manual. However, the use of high-pressure cleaning equipment can cause water ingress, resulting in damage to, or failure of, the equipment.

WARNING LABEL

A warning label is attached to the processor unit. Do not remove the label. If the label is missing or damaged, contact your dealer about replacement.

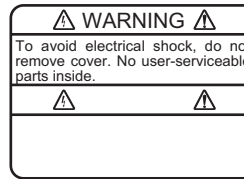

Name: Warning Label (1)

Type: 86-003-1011

Code No.: 100-236-231

About the TFT LCD

The TFT LCD is constructed using the latest LCD techniques, and displays 99.99% of its pixels. The remaining 0.01% of the pixels may drop out or blink, however this is not an indication of malfunction.

HOW TO STOP AUTO STEERING IN AN EMERGENCY

Stop the auto steering by the autopilot in an emergency and control the rudder manually, such as when the rudder is unintentionally moved or auto steering cannot be canceled. Do as follows to stop the autopilot.

- For analog steering system: Use the steering control changeover feature* of the steering system to stop the auto steering, then turn off the breaker of the autopilot.
*: Ask the manufacturer of the steering system.
- For solenoid steering system: Turn off the breaker of the autopilot.

TABLE OF CONTENTS

FOREWORD	vii
SYSTEM CONFIGURATION	ix
1. OPERATION	1-1
1.1 Controls	1-1
1.2 How to Turn Power On, Off	1-2
1.2.1 How to turn the power on	1-2
1.2.2 How to turn the power off	1-3
1.3 How to Adjust Screen and Key Brightness.....	1-3
1.4 Display Overview.....	1-4
1.4.1 Autopilot main screen.....	1-4
1.4.2 Header.....	1-5
1.5 User Menu Operation Overview	1-6
1.6 Parameter Menu.....	1-7
1.7 Work Profile Function	1-8
1.7.1 How to create a work profile	1-8
1.7.2 How to activate/deactivate a work profile	1-10
1.7.3 How to select a work profile	1-10
1.7.4 How to restore a work profile to the default settings	1-11
1.8 How to Select Ship Speed Used for Auto Steering	1-11
1.9 How to Select the Data Source	1-12
1.10 Heading Monitor Alert.....	1-12
1.11 Watch Alert.....	1-13
1.12 Off Heading Alert.....	1-13
2. STEERING MODES	2-1
2.1 Steering Modes Overview	2-1
2.1.1 Steering mode indication.....	2-1
2.1.2 Required NMEA 0183 sentences or NMEA 2000 PGNs.....	2-3
2.2 STBY Mode	2-4
2.3 AUTO Mode.....	2-4
2.3.1 AUTO mode	2-4
2.3.2 Advanced AUTO mode	2-5
2.3.3 Course after operation of a remote controller.....	2-6
2.4 NAV Mode (non-IMO type only)	2-7
2.4.1 How to activate the NAV mode	2-8
2.4.2 Sailing method for the NAV mode	2-8
2.4.3 Waypoint switching method.....	2-9
2.4.4 How to set the audible alarm on arrival	2-10
2.5 Turn Mode	2-10
2.5.1 How to select a turn and start the turn	2-10
2.5.2 How to set the angle for turns	2-11
2.6 FU/NFU Mode	2-12
2.6.1 FU (Follow Up) mode	2-12
2.6.2 NFU (Non-Follow Up) mode.....	2-12
2.7 RC FU/NFU Mode	2-13
2.7.1 RC FU mode	2-13
2.7.2 RC NFU mode (non-IMO type only)	2-14

TABLE OF CONTENTS

3. ALERTS	3-1
3.1 What is an Alert?	3-1
3.2 Alert Box.....	3-2
3.3 How to Acknowledge an Alarm or Warning.....	3-3
3.4 Alert List	3-4
3.5 Alert Log.....	3-5
3.6 Alert Reception from Connected Sensors.....	3-6
4. HOW TO CUSTOMIZE YOUR NAVPILOT	4-1
4.1 How to Adjust the Key Beep Volume	4-1
4.2 How to Adjust the Buzzer Volume (non-IMO type only).....	4-1
4.3 How to Activate the Key Lock Function.....	4-2
4.4 How to Change the Display Format	4-2
4.5 How to Show the Software Version.....	4-3
4.6 Installation Menu	4-3
5. MAINTENANCE	5-1
5.1 Preventive Maintenance.....	5-1
5.2 Troubleshooting	5-2
5.3 Replacement of Fuse	5-3
5.4 How to View the Sensors in Use.....	5-4
5.5 Diagnostics.....	5-4
5.5.1 Processor unit test	5-4
5.5.2 Control unit test.....	5-5
5.5.3 Keyboard test.....	5-6
5.5.4 Screen test.....	5-7
5.6 How to Restore All User Menus to Factory Default.....	5-7
APPX. 1 MENU TREE	AP-1
APPX. 2 ALERT LIST	AP-2
APPX. 3 ABBREVIATIONS	AP-7
APPX. 4 TERM OF USE FOR OPEN SOURCE SOFTWARE	AP-9
SPECIFICATIONS	SP-1
INDEX	IN-1

FOREWORD

A Word to the Owner of the NAVpilot-1000

Congratulations on your choice of the NAVpilot-1000. We are confident you will see why the FURUNO name has become synonymous with quality and reliability.

Since 1948, FURUNO Electric Company has enjoyed an enviable reputation for innovative and dependable marine electronics equipment. This dedication to excellence is furthered by our extensive global network of agents and dealers.

Your equipment is designed and constructed to meet the rigorous demands of the marine environment. However, no machine can perform its intended function unless properly operated and maintained. Please carefully read and follow the operation and maintenance procedures set forth in this manual.

Thank you for considering and purchasing FURUNO.

We would appreciate feedback from you, the end-user, about whether we are achieving our purposes.

Features

The NAVpilot-1000 is designed for use with commercial/merchant vessels up to 100 m in length. The main features of the NAVpilot-1000 are:

- Supports connection with analog and solenoid steering system that used in many commercial ships/workboats.
- Compatible with various communication interfaces.
The NAVpilot has IEC61162-1/2 (4 ports), IEC61162-450 (100BASE TX) and NMEA 2000 port. to connect with navigation and maintenance equipments.
- Power supply from the processor unit to the control unit.
The processor unit can supply the power to a maximum of three control units. There is no need to wire the power line individually, simplifying installation.
Note: If four or more control units are connected, connect the power isolator to the NMEA 2000 (CAN bus) network and provide the external power supply to the backbone.
- Supports connection to a wide variety of third-party RRUs.
Compatible with potentiometer type, analog voltage type, analog current type, frequency type RRUs.
- Network up to three FU type remote controllers and NFU type remote controller.
Note 1: NFU type remote controller is available only for the non-IMO type.
Note 2: FU and NFU type remote controllers are available only when an RRU is installed.
- Easy steering parameters adjustment.
The work profile function lets you store six sets of custom parameters and settings. This allows individual users to quickly set the system according to their preferences.
- Available in either IMO-compliant and non-IMO-compliant configuration (set at installation).

Program Numbers

System	Program no.	System	Program no.
Control unit (FAP-10001)		Processor unit (FAP-10002)	
App	6454041-xx.xx	App	6454045-xx.xx
Boot	6454042-xx.xx	Boot	6454046-xx.xx

“xx.xx” denotes software version number.

Regulation Type and Function Availability

The NAVpilot is available in two regulation types: IMO type or non-IMO type. Function availability depends on regulation type. If your ship needs SOLAS certification, use the IMO type. The regulation type is set at installation.

This manual provides descriptions for all functions of this equipment, and we have endeavored to denote in the text those functions that have limited availability. For detailed information on the function availability, see the menu tree at the back of this manual.

CE/UKCA Declaration

With regards to CE/UKCA declarations, please refer to our website (www.furuno.com) for further information about RoHS conformity declarations.

Disclosure of Information about China RoHS

With regards to China RoHS information for our products, please refer to our website (www.furuno.com).

SYSTEM CONFIGURATION

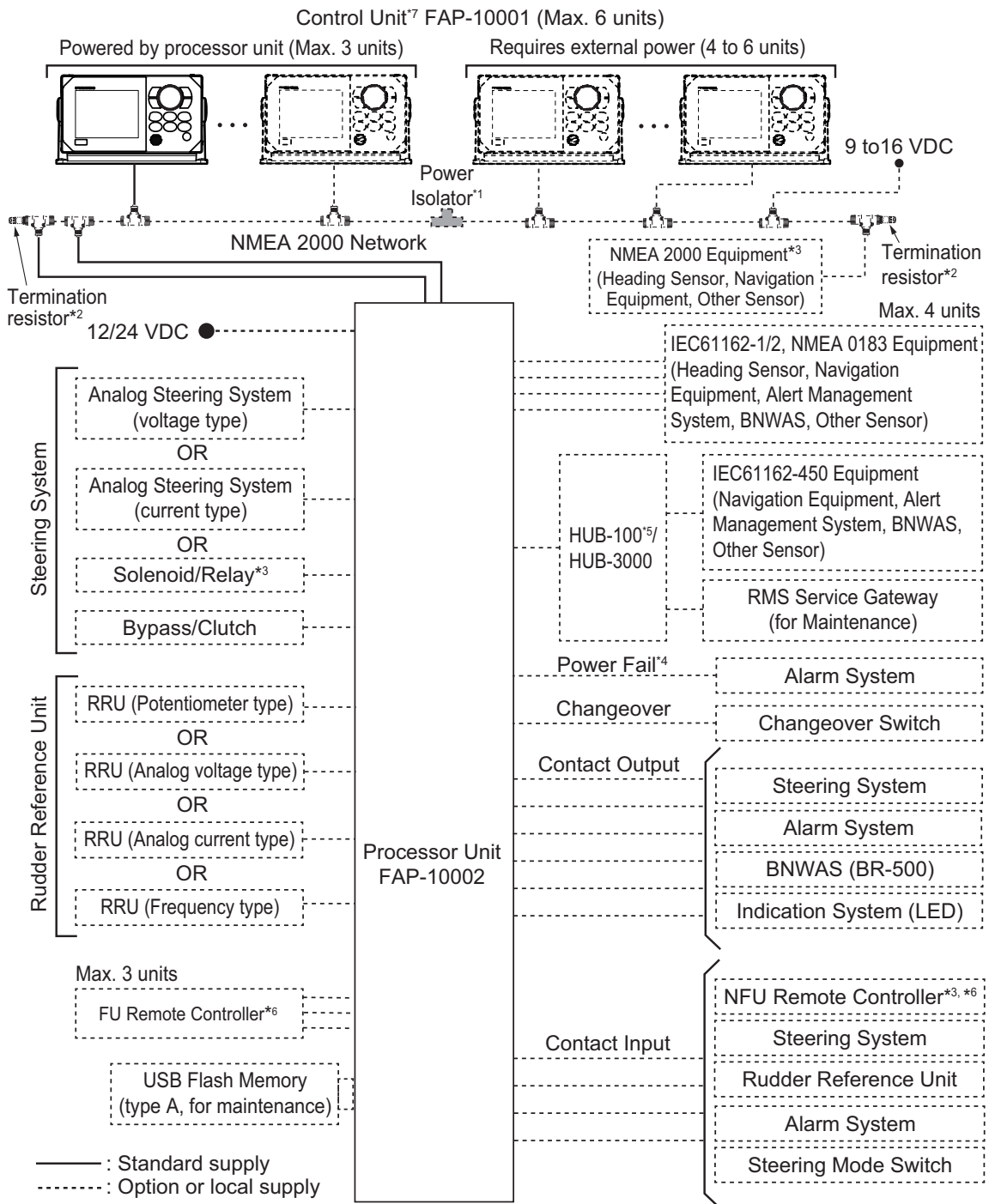

- *1: When four or more control units are connected, connect the power isolator to the NMEA 2000 network and provide the external power supply to the backbone.
- *2: Termination resistors must be installed at both ends of the backbone.
- *3: Available only for the non-IMO type.
- *4: For the IMO type, power fail signal must be connected to an external alarm system in accordance with ISO 11674. For details of wiring, see the Installation Manual.
- *5: HUB-100 can only be used for IEC61162-450 Ed.1 compliant network.

Category of units

Processor unit	Protected from the weather.
Control unit	Protected from the weather.

- *6: Available only when the RRU is installed.
- *7: If your ship does not need SOLAS certification, the control unit can be connected directly to the processor unit without connecting via the NMEA 2000 backbone, using the optional cable assembly (type: FRU-LMT-18-SINGLE). For details, see the next page.

Connection when using the optional cable assembly

If your ship does not need SOLAS certification, the optional cable assembly (type: FRU-LMT-18-SINGLE) can be used. This allows you to connect the control unit and processor unit directly without connecting via the NMEA 2000 backbone. In this case, note that only one control unit can be connected and NMEA 2000 equipment cannot be connected to the NAVpilot.

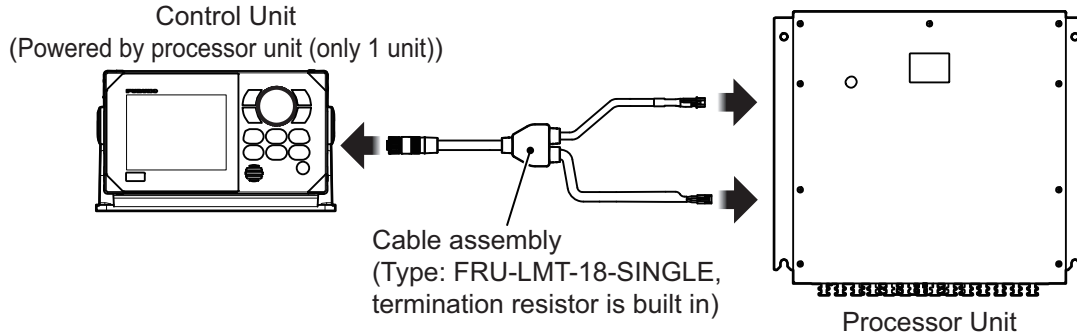

Compatible external equipment

The following table shows the external equipment that have been verified for use with the NAVpilot.

Equipment	Manufacturer	Model	Remarks
FU Remote Controller	Jastram	JAS-LC1-FFU	
NFU Remote Controller	Jastram	JAS-LC1-NFU	Not compatible with active switch
RRU (Analog Current Type)	DEIF	RTA602	
RRU (Frequency Type)	SIMRAD	RF-45X	For frequency type RRU, RF-45X is only compatible.

1. OPERATION

1.1 Controls

The figure and table below show an overview of the control unit with a brief description of its controls.

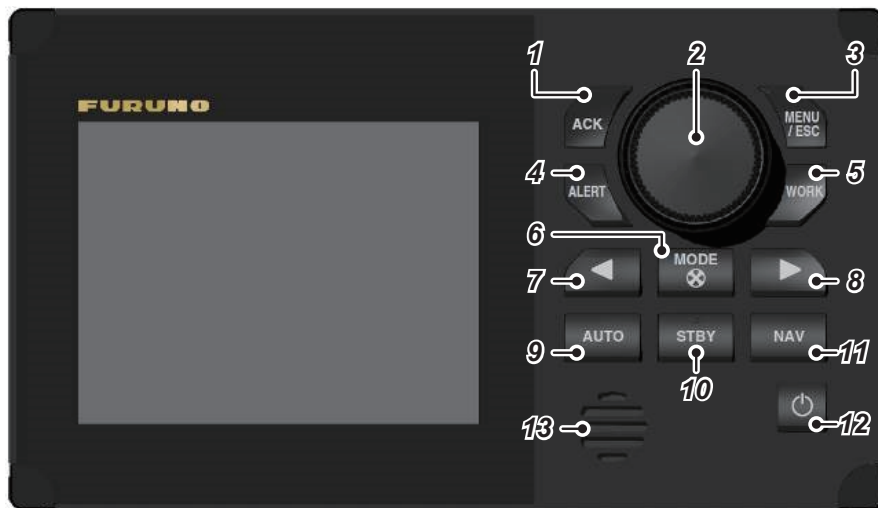

No.	Name	Description
1	ACK key	Acknowledges active alerts and temporarily silences the alert buzzer.
2	Course control knob	Controls course and selects menu items. Rotate: Sets course to AUTO mode; highlight a menu item or setting option. Push: Confirms menu selection or setting.
3	MENU/ESC key	<u>With menu closed:</u> Short press: Opens the [Parameter Menu] window. Long press: Opens the user menu. <u>With menu open:</u> Closes menu and cancels unconfirmed menu selections.
4	ALERT key	Shows the [Alert List] window.
5	WORK key	Short press: Shows the work profile list; selects a profile to use. Long press: Opens the editing menu of the current work profile.
6	MODE key	Opens the [Select Mode] window to select the steering mode.
7	PORT key	Manually adjusts the steering to port.
8	STBD key	Manually adjusts the steering to starboard.
9	AUTO key	Activates the AUTO mode.
10	STBY key	Deactivates the current steering mode and puts the NAVpilot into the STBY mode.
11	NAV key	Activates the NAV mode. Note: The NAV mode is available only for the non-IMO type.
12	Power key	Short press with the power off: Turns the power on. Short press with the power on: Shows the screen and key brightness settings window. Long press: Turns the power off.

1. OPERATION

No.	Name	Description
13	Speaker	Activates key beeps and alert sounds. Note: A thin waterproofing sheet is attached to the speaker on the control unit. Do not insert brushes or other objects into the speaker holes when cleaning them. If the sheet is torn, the speaker may be damaged if water leaks through the holes.

1.2 How to Turn Power On, Off

1.2.1 How to turn the power on

Press and release the **Power** key (⏻) to turn the power on.

The NAVpilot-1000 shows the startup screen for a short period of time, while the internal diagnostic check is performed. When the diagnostic is completed, the results appear on the screen. If the test results are all successful (no items appear as "NG"), the Autopilot main screen appears.

Note: When the heading sensor is PG-700/Satellite Compass™, do not set sail for four minutes after turning on the heading sensor. This allows time for the heading sensor to output heading data.

If "NG" appears for any item, an error message, shown in the table below, appears. Follow the information provided in the message to restore normal operation. If you cannot restore normal operation, contact a FURUNO dealer for information. The tabled messages are listed in order of priority from highest to lowest.

Error message	Meaning
Communication error with the processor unit. Check connections. Contact your local dealer if the problem recurs.	The processor unit may be turned off or disconnected. Check that the power is supplied to the processor unit, then check the NMEA2000 network connections between the processor unit and control unit. If the error is not rectified, contact your dealer.
Processor has failed the startup test. Contact your local dealer.	Processor unit requires inspection by a qualified technician.
Controller has failed the startup test. Contact your local dealer.	Control unit requires inspection by a qualified technician.
Processor backup data is corrupt or lost. Processor factory defaults will be restored. Press any key to continue.	Previously saved backup data is either lost or corrupted and cannot be used. Factory default settings will be used to start the equipment. User settings must be re-entered.
Controller backup data is corrupt or lost. Controller factory defaults will be restored. Press any key to continue.	
Control unit and processor unit software versions do not match. Update software to latest version.	The software version of the control unit and the processor unit are different. Update to the latest version of software for both units.

If there is more than one error, the error with the next highest priority appears. To clear the message(s) from the screen, press any key once for each message.

1.2.2 How to turn the power off

Press and hold the **Power** key (⏻) to show the [Power OFF] window.

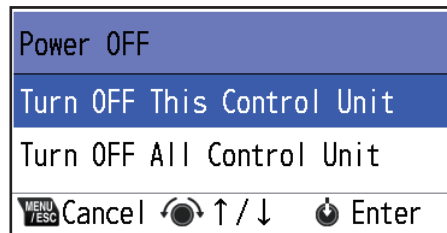

Select [Turn OFF This Control Unit] to power off this control unit, or [Turn OFF All Control Unit] to power off this control unit and all other control units in the same network.

1.3 How to Adjust Screen and Key Brightness

1. Press and release the **Power** key (⏻) to show the screen and key brightness settings window.

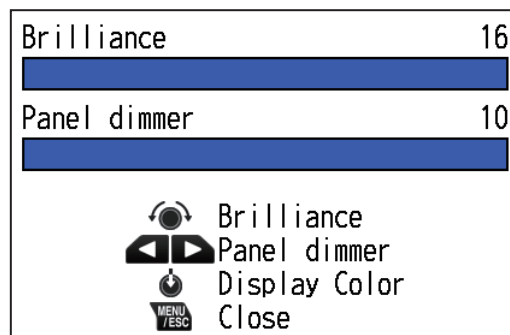

Note: If there is no input from the user (controls used or settings adjusted) for a short period of time, the settings window automatically closes.

2. Operate the **Course control** knob to adjust the brilliance (screen brightness).
3. Operate the **PORT** key (◀) or **STBD** key (▶) to adjust the panel dimmer (key brightness).
4. Push the **Course control** knob to switch the display color (white background or black background).

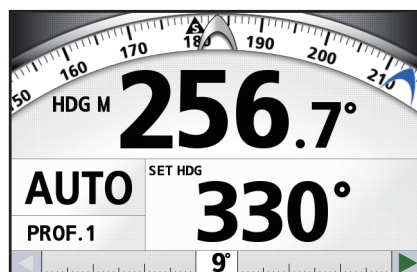

Example: White background



Example: Black background

5. Press the **MENU/ESC** key to close the settings window.

Note: You can restore the brilliance, panel dimmer and display color to the default settings; press and hold the **Course control** knob while the brightness settings window is open. Default settings are as follows:

- Brilliance: 15 (setting range: 1 to 16)
- Panel dimmer: 10 (setting range: 1 to 10)
- Display color: White background

1.4 Display Overview

Note: If the communication error between the processor unit and control unit occurs, the message shown to the right appears and the buzzer sounds.

Lost communication with processor unit.
Check connections.

Also, the steering indication shows "UNKNOWN". Check the connection with the processor unit.

1.4.1 Autopilot main screen

The Autopilot main screen is divided into several areas, as illustrated below.

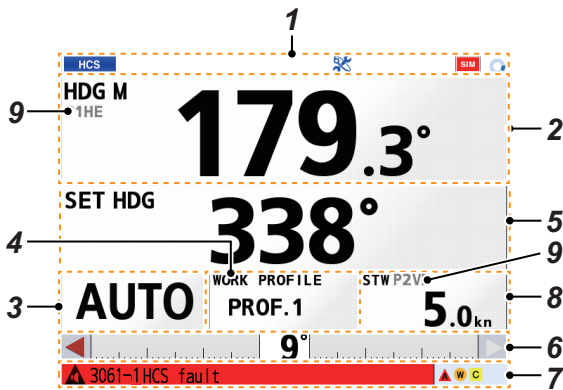

Example: [Screen Display] = [Digital]

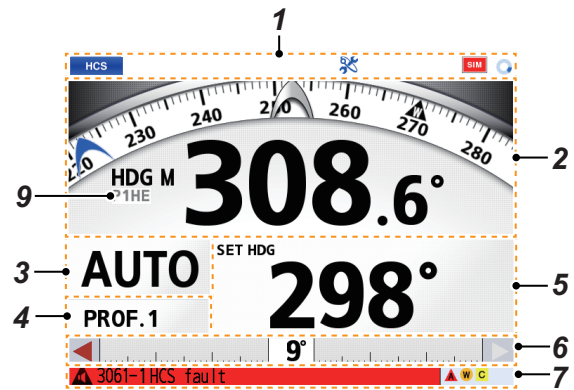

Example: [Screen Display] = [Graphic]

No.	Name	Description				
1	Header	Displays the current status with various icons. For details, see subsection 1.4.2.				
2	Heading indication	Shows the current ship's heading. When the "Doubtful heading" alert occurs, the heading indication is shown in yellow.				
3	Steering mode	Shows the current steering mode. See section 2.1.				
4	Work profile	Shows the work profile name selected. For details, see section 1.7.				
5	Steering mode data	Data shown in this area depends on the current steering mode. For details, see chapter 2.				
6	Rudder indication	Shows the rudder angle and steering direction. Red-colored segments indicate rudder to port, green segments indicate rudder to starboard. <table border="1" style="width: 100%; margin-top: 10px;"> <thead> <tr> <th>RRU is installed</th> <th>RRU is not installed</th> </tr> </thead> <tbody> <tr> <td> <p>Rudder limit Rudder angle</p> <p>Order angle</p> <p>Shows the rudder angle, rudder limit and steering direction. The order angle marker is shown only in the FU mode.</p> </td> <td> <p>Shows the order angle and steering direction.</p> </td> </tr> </tbody> </table> <p>Note: If the rudder order angle exceeds the rudder limit threshold, the rudder limit indication is highlighted in yellow.</p>	RRU is installed	RRU is not installed	<p>Rudder limit Rudder angle</p> <p>Order angle</p> <p>Shows the rudder angle, rudder limit and steering direction. The order angle marker is shown only in the FU mode.</p>	<p>Shows the order angle and steering direction.</p>
RRU is installed	RRU is not installed					
<p>Rudder limit Rudder angle</p> <p>Order angle</p> <p>Shows the rudder angle, rudder limit and steering direction. The order angle marker is shown only in the FU mode.</p>	<p>Shows the order angle and steering direction.</p>					

No.	Name	Description
7	Alert box	Shows operational and system alert messages. For details, see section 3.2.
8	Data box	Shows the ship's speed (SOG, STW or manual ship's speed). The data shown in the data box depends on the setting of the [Speed Calculation]. See section 1.8.
9	Data source	Displays the information of the data source. The information displayed depends on the connected interface and data source. <ul style="list-style-type: none"> • NMEA 0183: Displays the port number and talker. For example, when the data source equipment whose talker is "GP" is connected to the PORT 2, "P2GP" is shown. • LAN (IEC61162-450): Displays the SFI. • NMEA 2000: Displays "N2K".

Note 1: Unless otherwise indicated, the screen examples shown in this manual are based on when [Screen Display] is set to [Digital].

Note 2: When input data for the following items exceeds the displayable range, the NAVpilot indication changes the color of data text to yellow-orange and an asterisk is attached to the applicable data.

- SOG
- STW
- XTE
- Rudder

1.4.2 Header

The header runs across the top of the screen. The header displays the current status with various icons.

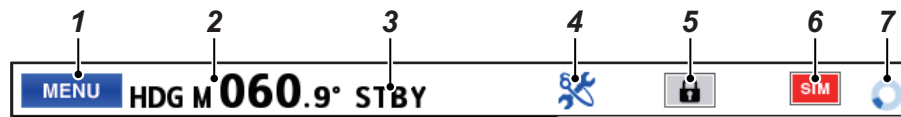

No.	Name	Description
1	Display mode icon	Shows the current display mode. <ul style="list-style-type: none"> • HCS : Shown in the Autopilot main screen for the IMO type. • AP : Shown in the Autopilot main screen for the non-IMO type. • MENU : Shown when the menu is open. • ALERT : Shown when the [Alert List] or [Alert Log] window is open.
2	Heading indication	Shows the current ship's heading. This indication is shown only when the menu is open.
3	Steering mode	Shows the current steering mode. This indication is shown only when the menu is open.
4	Remote maintenance icon	Indicates that the remote access function is activated. This icon is shown when [MP Menu] is set to [ON] (at installation).
5	Key lock icon	Indicates that the key lock function is activated. This icon is shown when [Key Lock] is set to [Lock]. For details, see section 4.3.
6	Simulation mode icon	Indicates that the simulation mode is activated. This icon is shown when [Simulation] is set to other than [OFF] (at installation).

No.	Name	Description
7	Working indicator	Spins clockwise if the system is working properly. If it is not spinning the system is not working.

1.5 User Menu Operation Overview

Most operations of your NAVpilot are done through the user menu. The instructions below provide a quick introduction on how to select a menu and change menu settings.

1. In the STBY, AUTO or NAV mode, press and hold the **MENU/ESC** key to open the user menu.

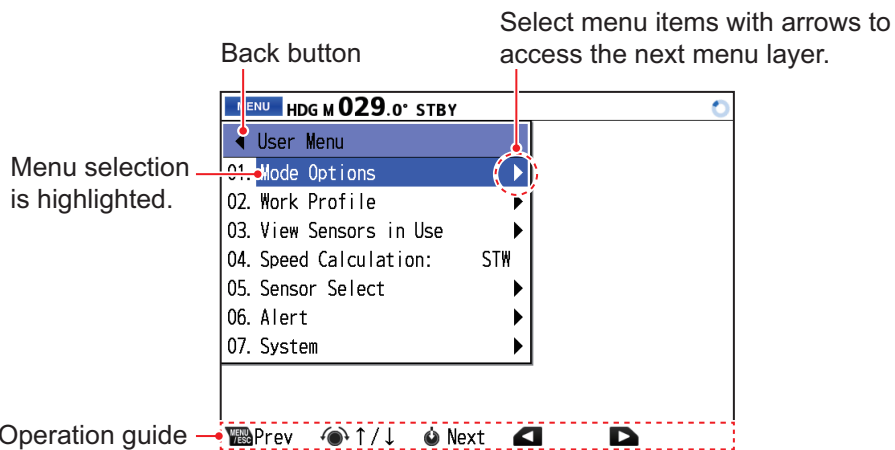

Note: You can also open the user menu by the following methods.

- Press the **MODE** key to open the [Select Mode] window, then rotate the **Course control** knob to select [Menu] and push the knob.
 - Press the **MENU/ESC** key to open the [Parameter Menu] window, then rotate the **Course control** knob to select [User Menu] and push the knob.
2. Rotate the **Course control** knob to select (highlight) a menu item, then push the knob.
 3. For the menu with “layers”, repeat step 2 as necessary. To go back one layer in a menu, press the **MENU/ESC** key.
 4. Rotate the **Course control** knob to select an option or setting, then push the knob.
 5. Press and hold the **MENU/ESC** key to close the user menu.

Note: For the sake of brevity, the procedures outlined in this manual use the following terminology/phrases when referring to menu operations.

- “Open/close the user menu.” This means “Open/close the user menu as outlined in step 1 or step 5 of the above procedure.”
- “Select xxx.” This means “Rotate the **Course control** knob to select xxx and push the knob” in similar manner as outlined in step 2 and step 3 of the above procedure.

1.6 Parameter Menu

You can adjust the NAVpilot steering parameters ([Weather Deadband], [Rudder Gain], [Counter Rudder]) from the [Parameter Menu] window. To open the [Parameter Menu] window, press the **MENU/ESC** key.

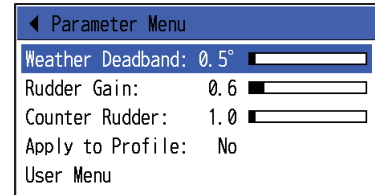

After adjusting the settings, set [Apply to Profile] to [Yes] to apply the settings to the current work profile.

Note 1: The parameters on the [Parameter Menu] window cannot be adjusted when [Self Learning] is set to [ON].

Note 2: Change parameters carefully because parameter changing is reflected to ship's motion immediately.

- [Weather Deadband]: When the sea is rough, the boat's heading fluctuates to port and starboard. If the rudder is driven very often to maintain the set course, the helm mechanism may wear out. To prevent this, the weather deadband adjustment makes the NAVpilot insensitive to minute course deviations. You may choose a degree between 1° to 10°. Until the course deviation exceeds the selected setting, steering to correct the heading will be minimized.

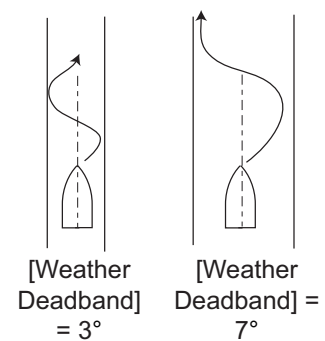

The illustration shown above shows boat's track lines with weather deadband setting 3° and 7°. When 7° is set, for example, the steering to correct the heading is minimized until the course deviation exceeds 7°. Increasing the setting reduces activation of the steering gear, however the boat tends to zig-zag. When the sea is calm, set a smaller value.

- [Rudder Gain]: When the boat's heading deviates from the set course, the NAVpilot adjusts the rudder to correct it. The rudder angle (number of degrees) which is steered against every degree of course deviation is known as the rudder gain.

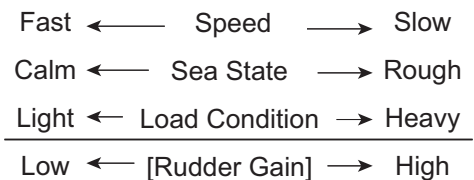

Set the rudder gain so that the boat does not make frequent yaw. The figure shown above provides general guidelines for setting the rudder gain.

- [Counter Rudder]: If the boat is heavily loaded, the heading could change excessively because of inertia. This phenomenon causes the vessel to "overshoot" the intended course. If this happens, the NAVpilot steers the rudder to the opposite side and the heading turns in the opposite direction excessively again. In an extreme case the heading oscillates several times until it finally

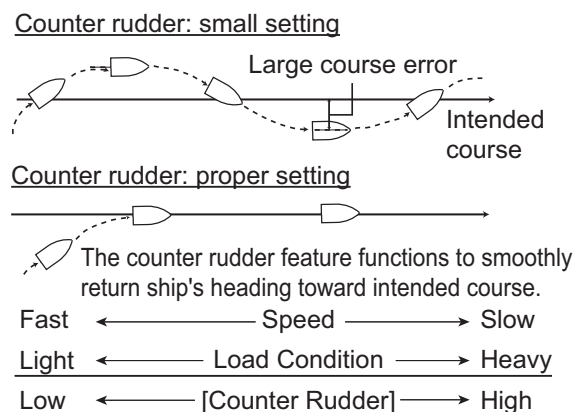

1. OPERATION

settles in the new course. An adjustment known as “counter rudder” prevents this kind of oscillation.

Counter rudder is usually not required for small boats. When your boat zigzags a lot before settling into the new course, increase the counter rudder setting.

Note: If the heading oscillates after a turn, lower [Rudder Gain] and raise [Counter Rudder].

1.7 Work Profile Function

The work profile function lets you store six sets of custom parameters and settings. This allows individual users to quickly set the system according to their preferences, sea conditions, etc.

1.7.1 How to create a work profile

To create or edit a work profile, do as follows:

1. Open the user menu.
2. Select [Work Profile].

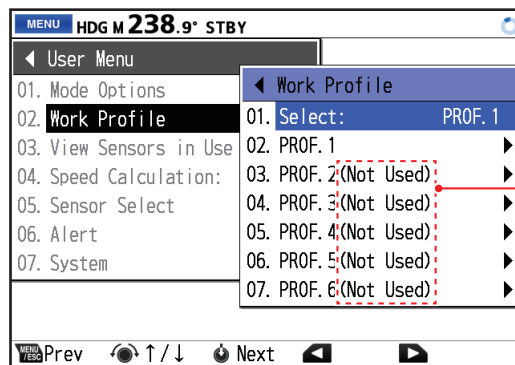

“(Not Used)” indicates that the work profile is not activated ([Use Profile] = [Not Used]).

3. Select the work profile name to be created or edited.

Note: The editing menu of the current work profile can be opened by pressing and holding the **WORK** key.

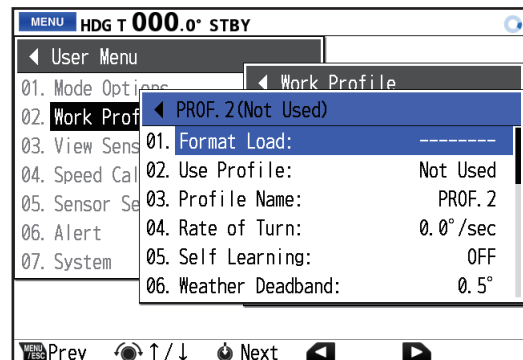

4. Set menu items, referring to the following table.

Menu item	Description
Page 1	
[Format Load]	Loads the selected work profile settings to the current work profile.
[Use Profile]	Select [Use] to activate the work profile.
[Profile Name]	Edits the work profile name (alphanumeric name with up to eight characters).

Menu item	Description
[Rate of Turn]/ [Radius of Turn]	<p>Sets the rate (or radius) of turn according to your boat's specifications. If this value is set higher than your boat's specifications, the rudder may turn abruptly when arriving at a waypoint, creating a dangerous situation. Further, it may not be possible to change course correctly if this value is higher than the actual rate (or radius) of turn of your vessel.</p> <p>Note 1: The rate (or radius) of turn may not be reached to the setting value under certain conditions of weather, sea, speed, load, draft, trim, etc. Furthermore, an incorrect speed input may lead to an incorrect radius control.</p> <p>Note 2: The menu name changes according to the [Turn Type] setting that is selected (at installation).</p>
[Self Learning]	<p>Select [ON] to activate the self-learning feature. The self-learning feature adjusts parameters for rudder ratio, counter rudder and auto trim gain. Those parameters are constantly optimized based on the steering history of your boat, and are stored in the memory for future navigation.</p> <p>Note 1: This menu item is shown when [Boat Length] is set to 85 ft or less (set at installation).</p> <p>Note 2: To use the self-learning feature, ship's speed data is required.</p>
[Weather Deadband]*	See section 1.6.
Page 2	
[Rudder Sensitivity]	<p>This value determines how quickly the rudder responds to yawing. Higher value makes the rudder move instantly on yawing, but the rudder responds to small yawing unnecessarily. Lower value makes the rudder to decrease unnecessary steering. But too low value causes delayed rudder response and large heading oscillation.</p>
[Rudder Gain]*	See section 1.6.
[Counter Rudder]*	See section 1.6.
[Trim Gain]	<p>The NAVpilot monitors steady heading error due to wind and current effects, and compensates this error by using the rudder offset (trim rudder angle). The trim rudder angle is adjusted at regular intervals. The trim gain determines the adjustment amount of the trim rudder angle.</p> <ul style="list-style-type: none"> • [Auto]: The trim gain is automatically set. • [Manual]: Set the trim gain manually. A lower setting is common because the boat's trim usually does not change quickly. Too high of a setting may result in serious oscillation of ship's heading, especially for a ship with poor course stability.
[Trim Response]	<p>Adjusts the update cycle for trim adjustment ([Low] or [High]).</p> <ul style="list-style-type: none"> • [Low]: Select when you want to reduce the frequency of steering turns. This setting is recommended for vessels sailing in open seas. • [High]: Select when you want to frequently compensate the steady heading error. This setting is recommended for small vessels, vessels navigating narrow passages, and a ship with poor course stability.
[Auto Rudder Limit]	Determine the maximum rudder movement in degrees from the mid position while auto steering by the NAVpilot.

1. OPERATION

Menu item	Description
Page 3	
[Rudder Start Position]	<p>Selects the rudder position to start auto steering.</p> <ul style="list-style-type: none"> [Centered]: Auto steering starts when the rudder is centered. [Actual]: Auto steering starts from the rudder position when auto steering is activated. The offset angle from the center is used as the trim angle. <p>Note: This menu item is available only when [RRU Sensor Type] is set to other than [Not Used] (at installation).</p>
[Rudder Offset]	Adjusts the offset value for the rudder angle at center position.
[Reset Default Settings]	Restores the default work profile settings for the work profile currently being edited.

*: Not available when [Self Learning] is set to [ON]. Also, these parameters can be adjusted from the [Parameter Menu] window. See section 1.6.

1.7.2 How to activate/deactivate a work profile

To activate or deactivate a work profile, do as follows:

1. Open the user menu.
2. Select [Work Profile].
3. Select the work profile name to be activated or deactivated.
4. Select [Use Profile].
5. Select [Use] to activate the work profile. To disable a work profile, select [Not Used].
6. Close the user menu.

1.7.3 How to select a work profile

To select a work profile, do as follows:

Select a work profile from the user menu

1. Open the user menu.
2. Select [Work Profile].
3. Select [Select: XXX] (XXX: work profile name that is currently selected).
4. Select the appropriate work profile.
5. Close the user menu.

Available work profile names appear.

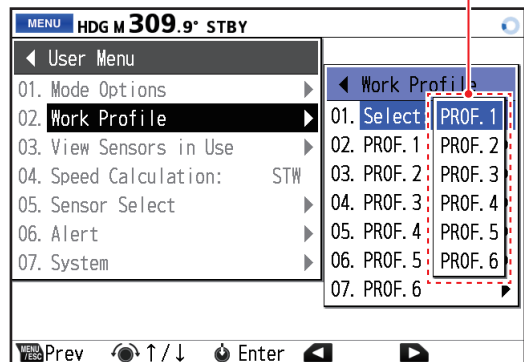

Select a work profile by the WORK key

1. Press the **WORK** key.
The [Select Profile] window appears.
2. Select the appropriate work profile.

Available work profile names appear.

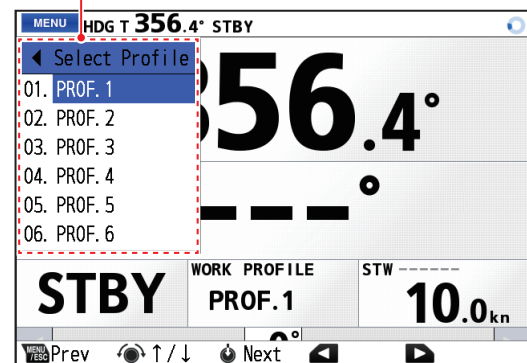
**1.7.4 How to restore a work profile to the default settings**

To restore a work profile to the default settings, do as follows:

1. Open the user menu.
2. Select [Work Profile].
3. Select the work profile name.
4. Select [Reset Default Settings].
5. Select [Yes] to restore the default settings.
6. Close the user menu.

1.8 How to Select Ship Speed Used for Auto Steering

Select the ship speed used for auto steering by the NAVpilot. The data selected here is also applied to the data box of the digital format screen.

1. Open the user menu.
2. Select [Speed Calculation].
3. Select [STW], [SOG] or [Manual].
 - [STW]/[SOG]: Ship speed from the speed sensor is used. Go to step 6.
 - [Manual]: Enter the ship speed manually. Go to the next step.
4. Select the current manual speed value.
5. Set the ship speed.
6. Close the user menu.

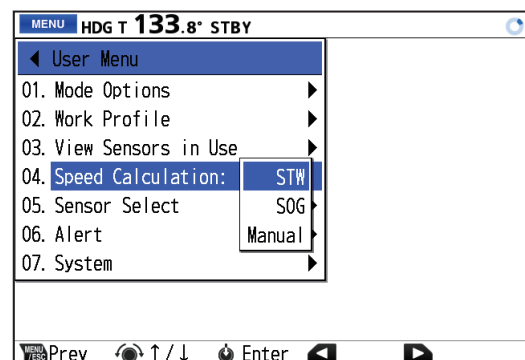

1.9 How to Select the Data Source

Do as follows to select the data source.

1. Open the user menu.
2. Select [Sensor Select].
3. Select the appropriate data to set the data source.
4. Select the sensor to use for navigation.

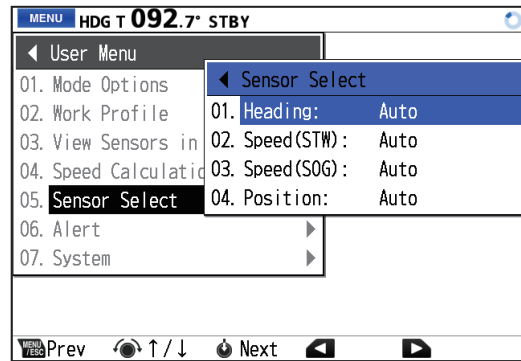

- [Auto]: When the main data source that is selected in the [Data Source] menu (set at installation) is lost, the NAVpilot automatically connects to the backup data source. Note that the NAVpilot keeps using the backup data source even if the communication error of the main backup source is rectified.
- [Main XXX*]: Use the main data source that is selected in the [Data Source] menu (set at installation).
- [Backup XXX*]: Use the backup data source that is selected in the [Data Source] menu (set at installation).

*: "XXX" indicates the port number that is selected in the [Data Source] menu (set at installation).

5. Close the user menu.

1.10 Heading Monitor Alert

The heading monitor alert monitors the difference between the heading values of the main and backup heading sensors (set at installation), and generates the "Doubtful heading" alert when the difference exceeds the setting value.

Note: For the IMO type, you cannot deactivate the heading monitor alert.

1. Open the user menu.
2. Select [Alert].
3. Select [Heading Monitor Alert].
4. For the non-IMO type, select [ON] or [OFF]. For the IMO type, go to the next step.
5. Select the current heading monitor alert value.
6. Set the threshold for the heading monitor alert.

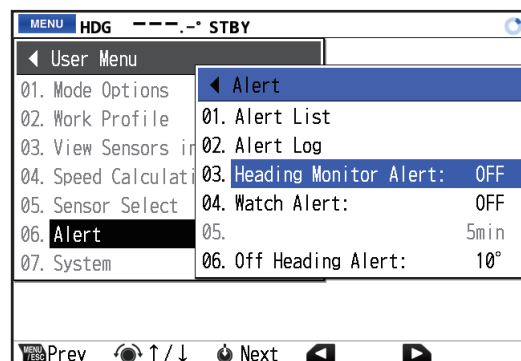

Note: The figure above is display example for the non-IMO type.

If the difference between the heading values of the main and backup heading sensors exceeds the value that is set here, the "Doubtful heading" alert occurs.

7. Close the user menu.

1.11 Watch Alert

The watch alert periodically warns the helmsman to check the NAVpilot when in the AUTO or NAV mode.

1. Open the user menu.
2. Select [Alert].
3. Select [Watch Alert].
4. Select [ON] or [OFF]. For [OFF], go to step 7.
5. Select the current watch alert value.
6. Set the time interval for the watch alert.
7. Close the user menu.

If the set time passes without operation, the buzzer sounds and the alert message appears. Further, if ten minutes elapses after the watch alarm has sounded, the alarm becomes louder. Press any key to clear the alert.

1.12 Off Heading Alert

The off heading alert* (deviation alert) sounds in the AUTO and NAV modes when the heading deviates more than the deviation alert value.

*: "Off heading alert" is a terminology defined by ISO 11674.

Note: The setting value of the off heading alert can be changed, but you cannot deactivate this alert.

1. Open the user menu.
2. Select [Alert].
3. Select [Off Heading Alert].
4. Set the degree of deviation.
5. Close the user menu.

1. OPERATION

This page is intentionally left blank.

2. STEERING MODES

This chapter describes the steering modes and functions of the NAVpilot.

Note: If the auto steering cancel button (local supply) is installed, the button cancels auto steering then switches to manual steering (STBY mode).

Cautions when switching steering modes

- **PG-700 heading sensor**
 - The message "Initializing heading sensor. This takes two minutes, please wait." may appear when switching steering modes. In this case, wait approx. two minutes to allow for initialization of the heading sensor, then switch steering modes.
 - When the heading sensor is restarted because of power supply interruption, etc. while the autopilot is controlling the rudder, the message indicated above appears and the autopilot stops the rudder control. If this happens, switch to the STBY mode, then steer the vessel manually.
- **Satellite Compass™ heading sensor**
 - The heading may not be output immediately after the Satellite Compass™ is powered on. Wait until the heading appears on the display.
 - The Satellite Compass™ may not be able to calculate heading when entering an area where satellites are blocked (for example, under a bridge). When this occurs, the message "Missing heading data" appears and the autopilot stops. Immediately switch to the STBY mode, then steer manually until the heading appears on the display.

2.1 Steering Modes Overview

2.1.1 Steering mode indication

The NAVpilot has various steering modes and the mode that is currently activated is shown on screen.

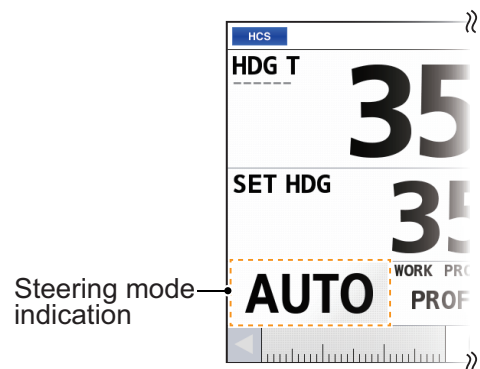

Indication	Description
STBY (standby) mode STBY	This is a manual steering mode. See section 2.2.
AUTO mode AUTO	The AUTO mode steers the boat automatically on the course set by the operator. This mode does not compensate for the effects of tide and wind. See subsection 2.3.1.

2. STEERING MODES

Indication	Description
Advanced AUTO mode ADV. AUTO	The Advanced AUTO mode steers the boat automatically on a course set by the operator. If either tide or wind begins to push you off course, the NAVpilot corrects your heading accordingly. See subsection 2.3.2.
NAV mode (Standard) NAV	NAVpilot steers the boat towards the current waypoint while compensating for the effects of tide and wind. See section 2.4.
NAV mode (Precision) PRE. NAV	[Precision] provides for tighter course keeping more than [Standard]. Note: The NAV mode is available only for the non-IMO type.
FU (Follow UP) mode* FU	In the STBY mode, NAVpilot steers to the rudder angle specified by the Course control knob. See subsection 2.6.1.
RC FU mode* RC1 FU	NAVpilot steers to the rudder angle specified by the dial on the remote controller. See subsection 2.7.1.
NFU (Non-Follow UP) mode* NFU	In the STBY mode, while operating the arrow keys, the NAVpilot steers the rudder in the specified direction. See subsection 2.6.2.
RC NFU mode* RC NFU	While operating the remote controller, the NAVpilot steers the rudder in the specified direction. See subsection 2.7.2.
INACTIVE mode INACTIVE	When a serious system alert occurs during auto steering by the NAVpilot, the INACTIVE mode is automatically enabled and the NAVpilot stops auto steering. Press the STBY key to switch to the STBY mode and steer manually. You cannot change the steering mode from the STBY mode until the system alert is rectified.
DISENGAGED mode DISENGAGED	The changeover switch is turned on and the rudder control with the NAVpilot is disabled. While the changeover switch is turned on, the DISENGAGED mode continues and the NAVpilot cannot change the steering mode. When the changeover switch switches to OFF, this mode is disabled and the NAVpilot automatically changes to the AUTO mode to maintain the course set at the moment the switch is turned off.
UNKNOWN mode UNKNOWN	The rudder control with the NAVpilot is disabled due to the communication error between the processor unit and control unit. The following message appears and the buzzer sounds during this mode. Check the connection with the processor unit. <div style="border: 1px solid black; padding: 5px; width: fit-content; margin: 10px auto;">Lost communication with processor unit. Check connections.</div>

*: Available only when an RRU is installed.

2.1.2 Required NMEA 0183 sentences or NMEA 2000 PGNs

The following NMEA 2000 PGNs or NMEA 0183 sentences are required for each steering mode.

Input Data	NMEA 0183 Sentence	NMEA 2000 PGN	Steering Mode			
			AUTO	Advanced AUTO	NAV	Turn
Heading (True) ^{*1}	THS/HDT/HDG	127250	✓	✓	✓	✓
Heading (Magnetic) ^{*1}	HDG/HDM	127250	✓	✓	✓	✓
Speed Log (SOG) ^{*2}	VTG/RMC	128259/ 129026/ 130577	✓	✓	✓	✓
Speed Log (STW) ^{*2}	VBW/VHW	128259/ 130577	✓	✓	✓	✓
Position	GNS/GGA/RMC/ GLL	129025/ 129029	—	✓	—	—
Waypoint	APB/RMB/BWR/ BWC/BOD/AAM	129284/ 129285	—	—	✓	—
Cross Track Error	XTE/APB/RMB	129283	—	—	✓	—

*1: Either true or magnetic heading selected at [Heading Display] is used.

*2: Either SOG or STW selected at [Speed Calculation] is used.

2.2 STBY Mode

After turning on the power, the equipment goes to the STBY (standby) mode. This is the manual steering mode. When sailing into or out of a harbor, you can steer the vessel while in the STBY mode, by using the helm (steering wheel) of your boat.

The STBY mode is displayed in digital format as shown in the example below.

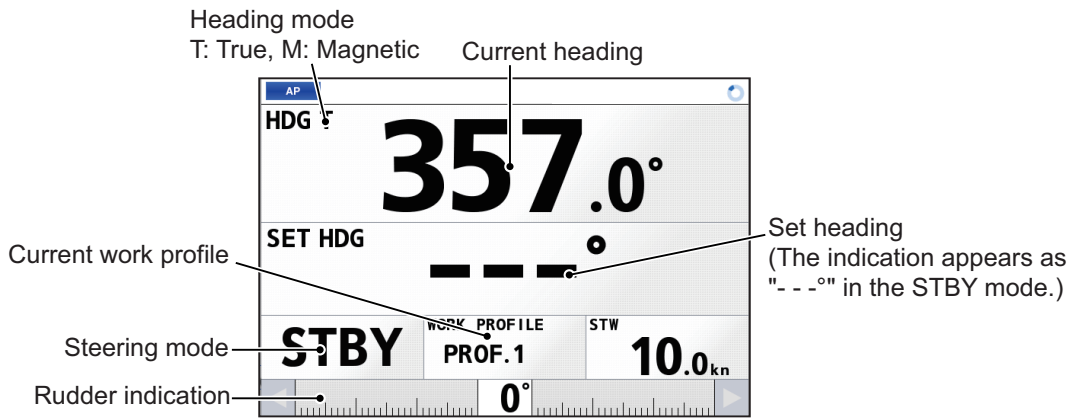

2.3 AUTO Mode

2.3.1 AUTO mode

The AUTO mode steers the boat automatically on the course set by the operator.

The AUTO mode does not compensate for the effects of wind or tide, which can push you off course athwart in the ship direction. Use the AUTO mode for short, straight voyages. Otherwise switch to the NAV mode (see section 2.4).

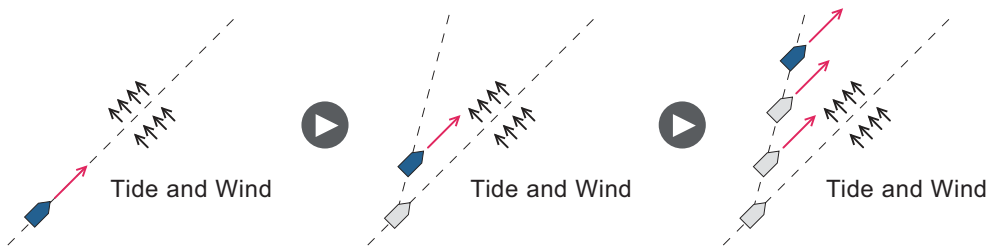

To get the AUTO mode, do as follows:

1. Direct the boat toward required course. When the RRU is not installed, confirm that the rudder angle is "0°" before activating the AUTO mode.
2. Press the **AUTO** key to activate the AUTO mode. Your boat automatically maintains the course set at the moment the key is pressed.

When the heading changes from the set course, the NAVpilot automatically adjusts the rudder to return the boat to the set course.

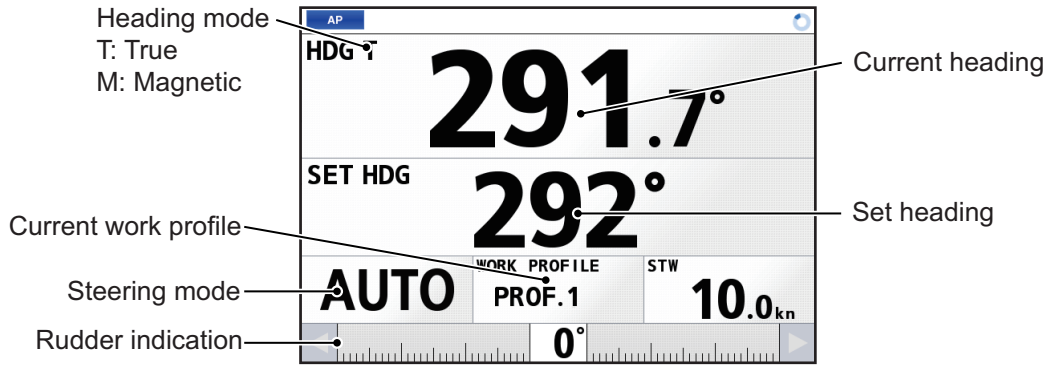

- To change the course setting in the AUTO mode, press the appropriate key, referring to the following table.

Operation	Description
PORT key (◀) is pressed	Change course by heading angle increment (set at installation) to port.
STBD key (▶) is pressed	Change course by heading angle increment (set at installation) to starboard.
Course control knob is rotated clockwise.	Change course by 1° to starboard.
Course control knob is rotated counter-clockwise.	Change course by 1° to port.

- To exit the AUTO mode to steer manually, press the **STBY** key. Steer your boat by the helm.

Note: You can also activate the AUTO mode from the [Select Mode] window. Press the **MODE** key to open the [Select Mode] window, then select [AUTO].

2.3.2 Advanced AUTO mode

The AUTO mode keeps a set course, but your boat's course can change by the effects of tide and wind. To adjust for the effects of tide and wind, use the Advanced AUTO mode. The NAVpilot calculates your course according to your current position and heading, then sets a virtual "waypoint" in its memory to navigate towards. If either tide or wind begins to push you off course, the NAVpilot corrects your heading accordingly.

This mode requires longitude and latitude position data from a GPS navigator.

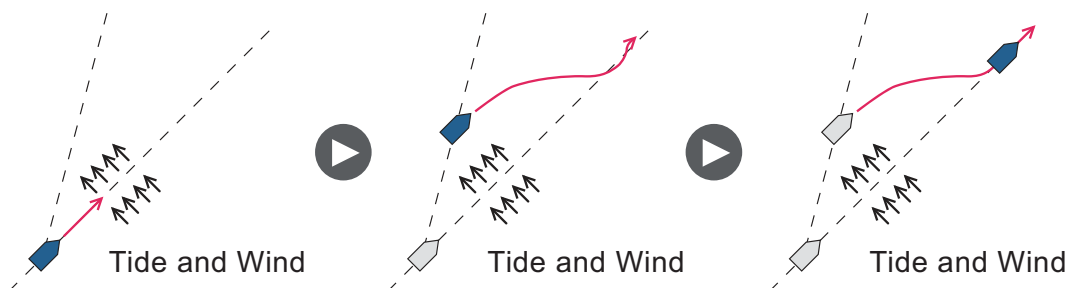

2. STEERING MODES

To activate the Advanced AUTO mode, do as follows:

1. Open the user menu.
2. Select [Mode Options].
3. Select [AUTO Options].
4. Select [Advanced AUTO].
5. Select [ON] to activate the Advanced AUTO mode. Select [OFF] to quit the Advanced AUTO mode.
6. Close the user menu.

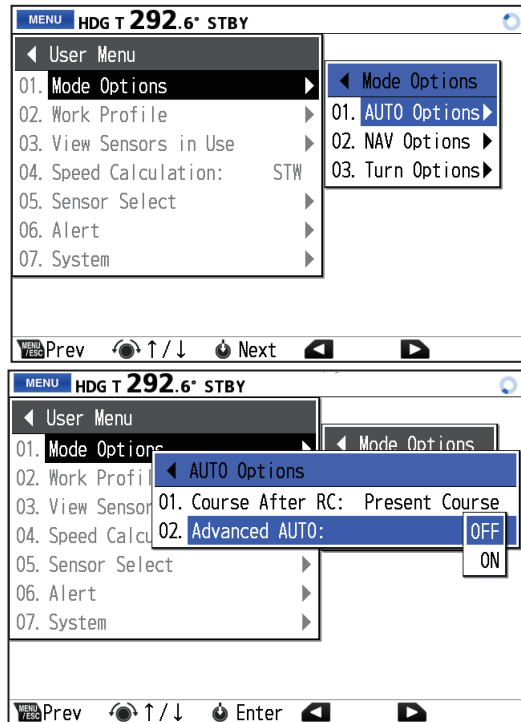

Note 1: You can switch between the AUTO and Advanced AUTO modes at any time in the AUTO mode. To switch, press and hold the **AUTO** key. The message “Advanced AUTO ON (OFF)” appears.

Note 2: How strictly the Advanced AUTO mode keeps the course depends on the [NAV Mode] setting in the [NAV Options] menu. [Precision] provides for tighter course keeping than [Standard].

Note 3: If the position data is lost while the Advanced AUTO mode is active, a message appears. The Advanced AUTO mode is deactivated, and the steering mode changes to the AUTO mode.

2.3.3 Course after operation of a remote controller

Select the course to follow after a remote controller is operated.

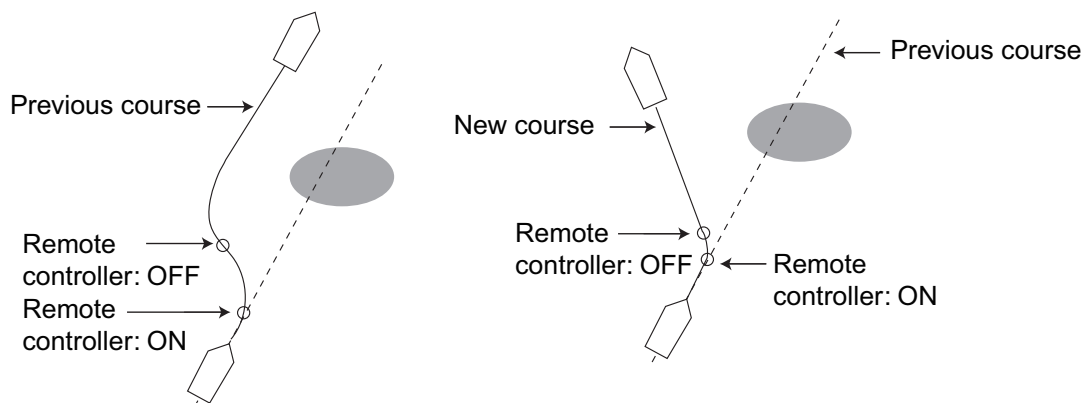

[Course After RC] = [Previous Course]

[Course After RC] = [Present Course]

1. Open the user menu.
2. Select [Mode Options].
3. Select [AUTO Options].
4. Select [Course After RC].
5. Select [Present Course] or [Previous Course].
 - [Previous Course]: Keep the course before the operation of a remote controller.
 - [Present Course]: Keep the course after the operation of a remote controller.
6. Close the user menu.

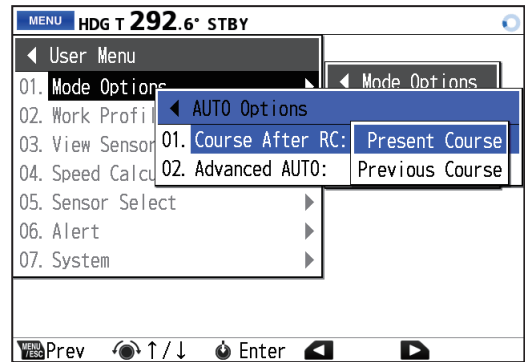

2.4 NAV Mode (non-IMO type only)

The NAVpilot steers the vessel towards the current waypoint while compensating for the effects of tide and wind.

When connected to a GPS navigator, NAVpilot steers the vessel to follow a series of waypoints in sequence. When you arrive at each waypoint or destination, audible and visual alerts are activated. You can deactivate the audible alarm on arrival. See section 2.4.4.

The NAVpilot takes 15 seconds to activate the NAV mode after the NAVpilot receives the destination information.

Note: The NAV mode is available only for the non-IMO type.

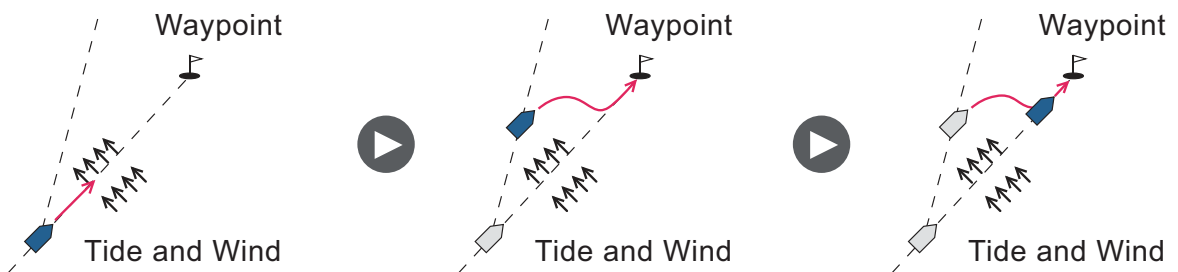

Steering to a single waypoint

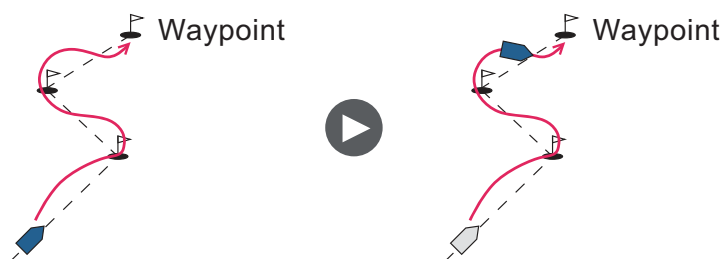

Steering a route (a series of waypoints)

2. STEERING MODES

2.4.1 How to activate the NAV mode

To activate the NAV mode, follow the procedure shown below.

1. Set the destination waypoint (or route) on the GPS navigator or chart plotter.
(To navigate a route, make sure that your chart plotter is navigating towards the nearest or required waypoint before you put the NAVpilot into the NAV mode.)
2. Manually steer the boat toward the waypoint.
3. Press the **NAV** key.

The following figure shows an overview of the NAV mode screen.

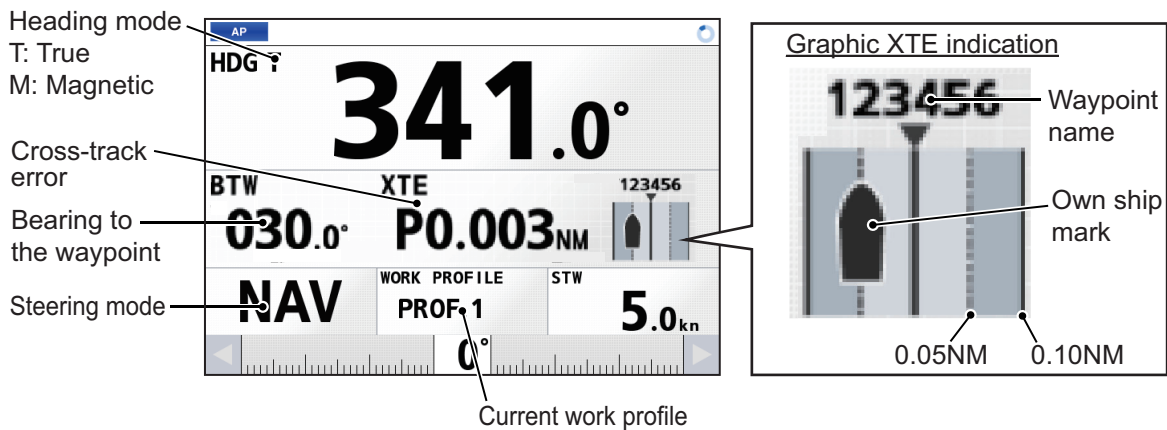

4. To exit the NAV mode to steer manually, press the **STBY** key. Steer your boat by the helm.

Note 1: The course reading on the NAVpilot is not always the same as the waypoint direction shown on the chart plotter.

Note 2: You can also activate the NAV mode from the [Select Mode] window. Press the **MODE** key to open the [Select Mode] window, then select [NAV].

2.4.2 Sailing method for the NAV mode

Your vessel can go off course between waypoints in the NAV mode. This can occur when, for example, a command is received from a remote controller. To return to the course set, two methods are available: [Standard] and [Precision].

[Standard] and [Precision] both use the XTE (cross-track error) value to steer the boat towards your original course before dodging. [Precision] provides for tighter course keeping than [Standard].

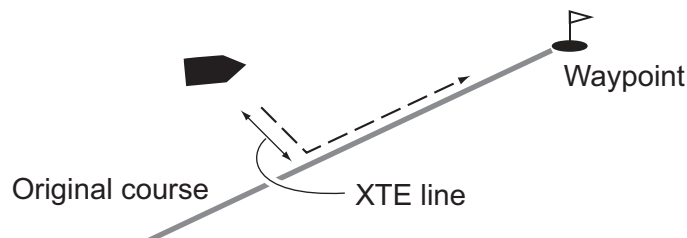

Select the sailing method as shown below.

1. Open the user menu.
2. Select [Mode Options].
3. Select [NAV Options].
4. Select [NAV Mode].
5. Select [Standard] or [Precision].
6. Close the user menu.

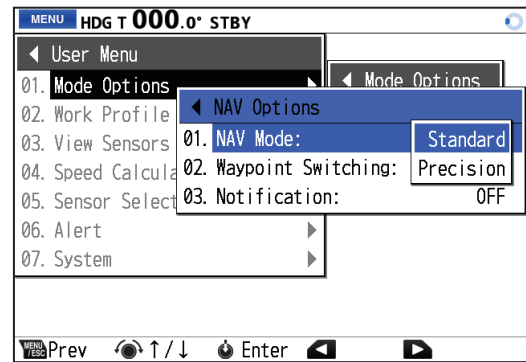

Note: You can switch between [Standard] and [Precision] at any time in the NAV mode. To switch, press and hold the **NAV** key. The message “NAV Mode was changed to Standard (Precision)” appears.

2.4.3 Waypoint switching method

When you arrive at a waypoint on a route in the NAV mode, you can switch to the next waypoint automatically or manually.

To select the waypoint switching method, follow the procedure below.

1. Open the user menu.
2. Select [Mode Options].
3. Select [NAV Options].
4. Select [Waypoint Switching].
5. Select [Auto] or [Manual].

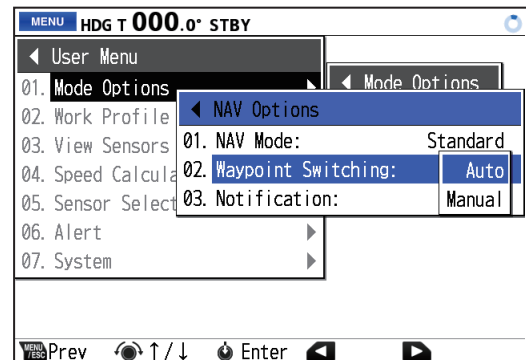

- [Auto]: Switches to the next destination waypoint when your boat is within the arrival alarm area (set on the chart plotter). When your boat is within the arrival alarm area, the audible alarm* sounds and a notification message appears.
- [Manual]: Requires operator confirmation before switching to the next waypoint. For manual switching, the NAVpilot sounds an audible alarm* when the boat is within the arrival alarm area for a destination waypoint and a confirmation message appears. Press any key to acknowledge the message and switch to the next waypoint. The message appears to inform that the waypoint was changed.

*: You can deactivate the audible alarm on arrival. See section 2.4.4.

6. Close the user menu.

2.4.4 How to set the audible alarm on arrival

When you arrive at each waypoint or destination, audible and visual alerts are activated. To set the audible alarm, do the following procedure.

1. Open the user menu.
2. Select [Mode Options].
3. Select [NAV Options].
4. Select [Notification].
5. Select [OFF], [5 sec] or [Continuous].
 - [OFF]: Audible alarm does not sound for arrival at each waypoint or destination.
 - [5 sec]: Audible alarm sounds for five seconds for arrival at each waypoint or destination.
 - [Continuous]: Audible alarm keep sounding for arrival at each waypoint or destination, until you acknowledge the waypoint arrival alert.
6. Close the user menu.

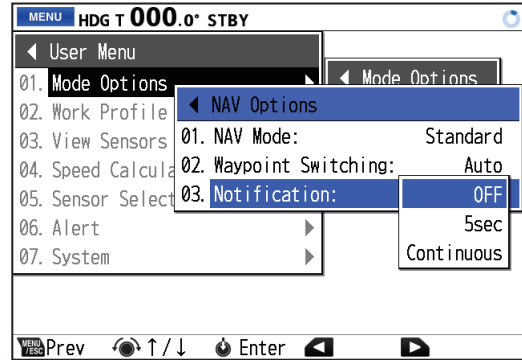

2.5 Turn Mode

The TURN mode turns the boat once only, in the selected direction.

2.5.1 How to select a turn and start the turn

The Turn mode has two types of turns available: Turn 1 (default: 45° turn) and Turn 2 (default: 90° turn). In the STBY, AUTO and NAV modes, you can select the turn direction (port or starboard). Further, the angle of the turn can be changed.

To activate the TURN mode, do the following procedure.

1. Press the **MODE** key to show the [Select Mode] window.

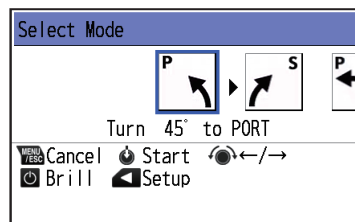

2. Select a turn. The cursor highlights current selection.

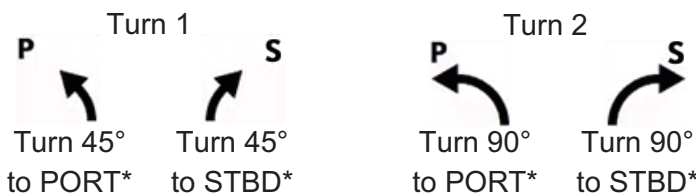

*: Turn angle for these turns depends on the menu setting. See subsection 2.5.2.

Note: The turn angle can be selected before the turn is started. Place the cursor on the appropriate icon and press the **PORT** key (), then select [Turn 1 (Turn 2) Angle]. After changing the turn angle, select [RUN] to start the turn.

3. Push the **Course control** knob to start the turn.

After you start the turn, an information message appears, and the audible alert sounds three times. The on-screen indications change during the turn in the manner shown in the following figure.

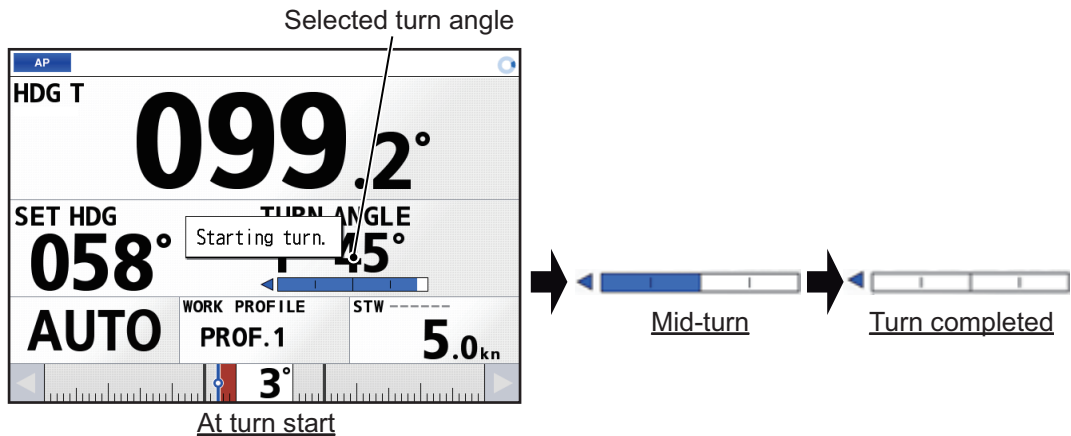

Turn indication when [Screen Display] is set to [Graphic]

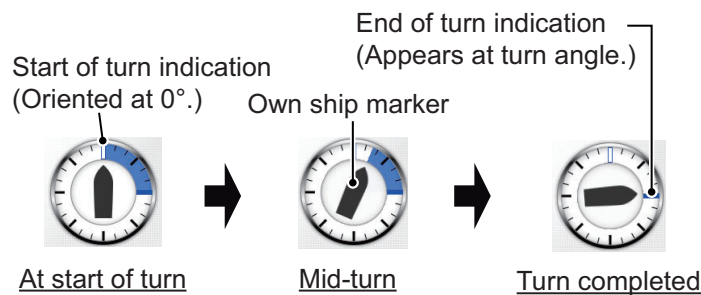

After the turn is completed, an information message appears. To escape from a turn, press the **STBY** key.

2.5.2 How to set the angle for turns

You can set the angle at which turns for Turn 1 and Turn 2 are made. To set these angles, follow the procedure below.

1. Open the user menu.
2. Select [Mode Options].
3. Select [Turn Options].
4. Select [Turn1 Angle] (or [Turn2 Angle]).
5. Set the desired turn angle.
6. Close the user menu.

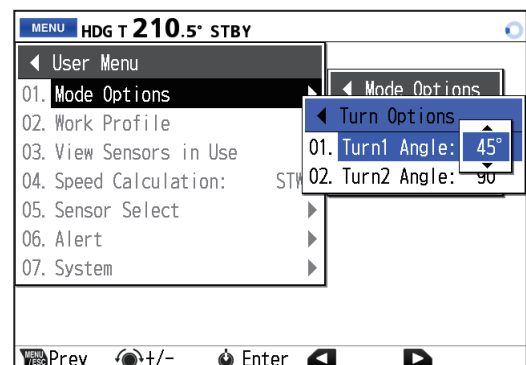

2.6 FU/NFU Mode

FU (Follow Up) and NFU (Non-Follow Up) modes are useful in situations where you need to quickly take control of the helm to avoid an obstruction.

- NFU: The rudder moves in the required direction until the **PORT/STBD** key or **Course control** knob is released. The rudder returns to center.
- FU: The rudder moves to the set turn angle and remains on that turn angle until manually adjusted.

Note: The FU and NFU modes are available only when an RRU is installed.

2.6.1 FU (Follow Up) mode

Press the **PORT** (◀) and **STBD** keys (▶) simultaneously in the STBY mode to activate the FU mode. When the FU mode is activated, the display changes as shown in the following figure.

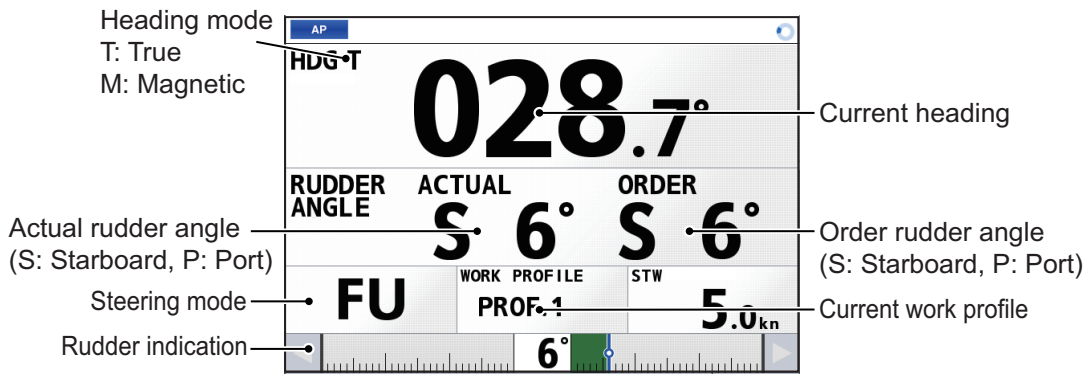

Rotate the **Course control** knob to adjust the order rudder angle and steer appropriately until the boat has cleared the obstruction.

To escape from the FU mode, press the **STBY** mode key. The NAVpilot goes to the STBY mode.

2.6.2 NFU (Non-Follow Up) mode

The NFU mode is a manual steering mode that moves the rudder as long as the **PORT** (◀) or **STBD** key (▶) is pressed. When the **PORT** (◀) or **STBD** key (▶) is pressed in the STBY mode, the NFU mode is activated and the display changes as shown in the following figure.

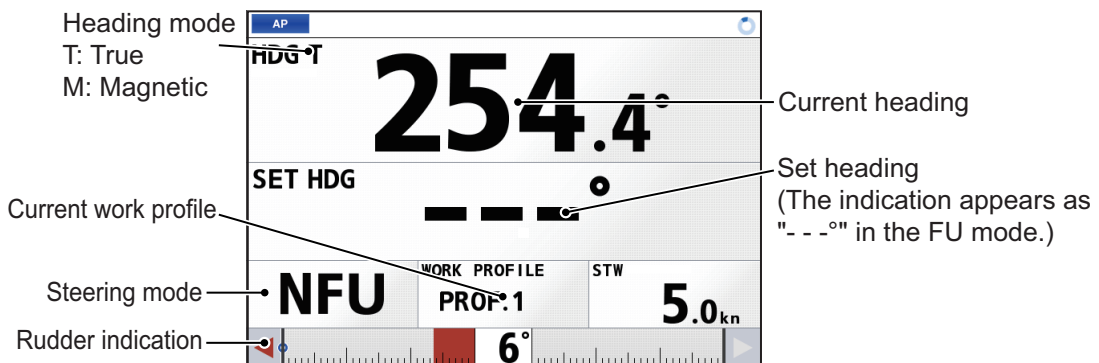

The rudder is moved in the direction in which the arrow key is pressed. To quit the NFU mode, release the arrow key. The NAVpilot goes to the STBY mode.

2.7 RC FU/NFU Mode

The NAVpilot can be connected to a FU or NFU type remote controller to control the NAVpilot from a remote location.

The RC FU and RC NFU modes are available in the STBY, AUTO or NAV mode.

To use the RC FU and RC NFU modes, the setup on the [Remote Controller] menu must be completed. If not completed, have a qualified technician complete the setup.

Note: The RC FU and RC NFU modes are available only when an RRU is installed.

2.7.1 RC FU mode

Note: When the remote controller is not used, center the lever of the remote controller. If not centered, the rudder moves unintentionally when the switch of the remote controller is turned on.

To activate the RC FU mode, do the following:

- When the remote controller has an active switch: Turn the switch on.
- When the remote controller does not have an active switch: RC FU mode is automatically activated when you operate the remote controller and the order rudder angle is changed by 3° or more.

Note: BEFORE controlling the NAVpilot from a remote controller, check the steering mode indication or use the output signal from the universal port to confirm that the RC FU mode is activated.

If multiple FU type remote controllers are connected, only the last activated remote controller has control rights and operation with other remote controllers is invalid. When you want to provide control rights to other remote controllers, do one of the above methods to activate the remote controller.

The remote controller number with control rights is shown at the bottom left of the RC FU mode screen. The NAVpilot can output the active status of the remote controller from the Universal Output port. You can check the active status by inputting the signal from the Universal Output port to the onboard indicator.

When the RC FU mode is activated, the display changes as shown in the following figure.

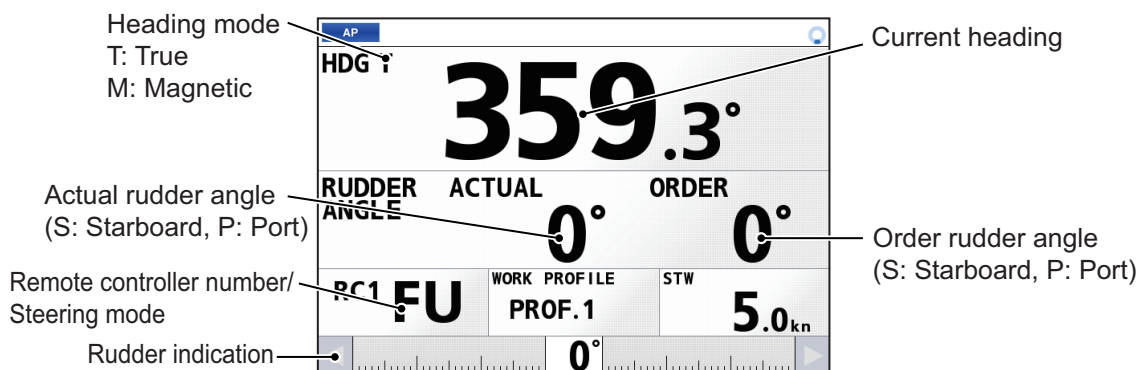

Operate the remote controller to set the order rudder angle.

2. STEERING MODES

To disable the RC FU mode, do the following:

- When the remote controller has an active switch: Turn the switch off.
- When the remote controller does not have an active switch: Quit the operation of the remote controller or press the **STBY** key. The lever of the remote controller is centered and the rudder is stopped for two seconds, then the RC FU mode is disabled.

After the RC FU mode is disabled, the steering mode is changed as follows:

- IMO type operation
When the RC FU mode is disabled, the NAVpilot goes to the AUTO mode.
- Non-IMO type operation
 - RC FU mode activation in the STBY mode: When the RC FU mode is disabled, the NAVpilot goes to the STBY mode.
 - RC FU mode activation in the AUTO or NAV mode: When the RC FU mode is disabled, the NAVpilot goes to the AUTO mode.

2.7.2 RC NFU mode (non-IMO type only)

The RC NFU mode is a manual steering mode that moves the rudder as long as the NFU type remote controller is operated. When the remote controller is operated, the NFU mode is activated and the display changes as shown in the following figure.

Note: The RC NFU mode is available only for the non-IMO type.

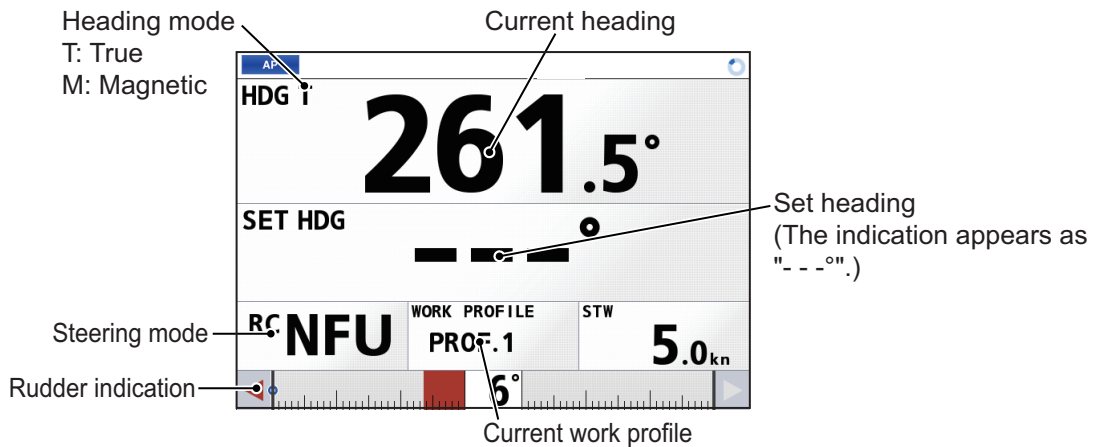

The rudder is moved in the direction specified by the remote controller. To escape from the RC NFU mode, center the lever of the remote controller. When the RC NFU mode is disabled, the NAVpilot goes to the STBY mode.

3. ALERTS

This chapter describes how the internal alert system works. For a complete list of alerts, See "ALERT LIST" on page AP-2.

Note 1: This equipment does not provide the functional alert group function.

Note 2: The reserved cluster identifier for this equipment, which is defined in IEC62923-2, is "Nav".

3.1 What is an Alert?

“Alert” is a generic name for a notice to any unusual or potentially dangerous situation generated within the system.

Alerts are classified according to priority and category.

Alert priority

There are three alert priorities: alarm, warning and caution.

Alarm: Situations or conditions which require immediate attention, decision and (if necessary) action by the bridge team to avoid any kind of hazardous situation and to maintain the safe navigation of the ship.

Warning: Conditions or situations which require immediate attention for precautionary reasons, to make the bridge team aware of conditions which are not immediately hazardous, but may become so.

Caution: Awareness of a condition which continues to require attention out of the ordinary consideration of the situation or of given information.

Alert category

An alert is further classified by category, A, B or C, according to its degree of severity or source.

Category	Description
A	Category A alerts include alerts indicating <ul style="list-style-type: none">• Danger of collision• Danger of grounding
B	Category B alerts are alerts where no additional information for decision support is necessary. Category B alerts are all alerts not falling under category A.
C	Alerts for other than navigation equipment (ex: Engine-related alert)

3.2 Alert Box

When an alert is generated, the related alert message and alert state icon appear in the alert box, which is at the bottom of the screen. An audible alarm is additionally generated for alarms and warnings.

In addition to the alert message and alert state icon, the alert box provides access to the [Alert List] and [Alert Log]. See section 3.4 and section 3.5.



Alert state icon: The state of an alert is shown with an icon. See "Alert state icons" on page 3-2.



Alert message area: The alert message area shows the name of the active alert with the highest priority, together with the alert ID. The color of both the message and the background change according to alert priority and alert state. See the table below.

Background alert icon: Shows the alert priority icon (A: alarm, W: warning, C: caution) of alerts, other than the alert currently displayed in the alert box. Background alert icons are shown only when two or more alerts are active. The icons disappear when alerts are acknowledged and rectified, and one or less alerts are active.

Alert state icons

The table shows the icons used to indicate the various alert states for the alarm, warning and caution alerts. Flashing icons flash every other second.

Icon	Alert state	Visual Indication	Audible alert
Alert priority: Alarm			
	Not acknowledged/ Not rectified	Red, flashing	Three short, audible alerts repeated every 7 seconds.
	Not acknowledged/ Not rectified, Buzzer temporarily silenced	Red, flashing	Silent
	Acknowledged/ Not rectified	Red	Silent
	Not acknowledged/ Rectified	Red, flashing	Silent
Alert priority: Warning			
	Not acknowledged/ Not rectified	Yellow-orange, flashing	Two short, audible alerts repeated every 60 seconds. Note: The Alert "Off-heading" is escalated from warning level to alarm level if the alert is not acknowledged within the time limit.
	Not acknowledged/ Not rectified, Buzzer temporarily silenced	Yellow-orange, flashing	Silent

Icon	Alert state	Visual Indication	Audible alert
	Acknowledged/ Not rectified	Yellow-orange	Silent
	Not acknowledged/ Rectified	Yellow-orange, flashing	Silent
Alert priority: Caution			
	Caution	Yellow	Silent

3.3 How to Acknowledge an Alarm or Warning

When an alarm or warning is generated, the buzzer sounds and the name of the alert appears and flashes in the alert box and [Alert List].

To acknowledge the alert, press the **ACK** key.

After acknowledgment, the buzzer and the flashing for the alert message are stopped and the priority of the alert changes as shown in the table below. The alert message remains on the display until the alert is rectified.

Priority no.	Priority of alert	Alert state	
High	1	Alarm	Not rectified/Not acknowledged
	2	Warning	Not rectified/Not acknowledged
	3	Alarm	Rectified/Not acknowledged
	4	Warning	Rectified/Not acknowledged
	5	Alarm	Not rectified/Acknowledged
	6	Warning	Not rectified/Acknowledged
	7	Caution	Not rectified
Low	8	No alert occurs	-

Category of alert and place of alert acknowledgment

The place of alert acknowledgment depends on the category of the alert.

Category	Where alert notification occurs	Place of alert acknowledgment
A	Equipment that generated the alert and AMS* (Alert Management System).	Equipment that generated the alert.
B	Equipment that generated the alert and AMS.	Equipment that generated the alert or AMS.
C	IAS (Integrated Automation System) generated alert for other than navigation equipment (ex: engine-related alert).	—

* A category A alert does not sound at the AMS.

3.4 Alert List

The [Alert List] window displays all active alerts, with unacknowledged alerts at the top, in priority order. When no active alert exists, "No Active Alerts" appears in the [Alert List] window.

To show the alert list, do one of following:

- Key operation: Press the **ALERT** key.
- Menu operation: Open the user menu, then select [Alert] → [Alert List].

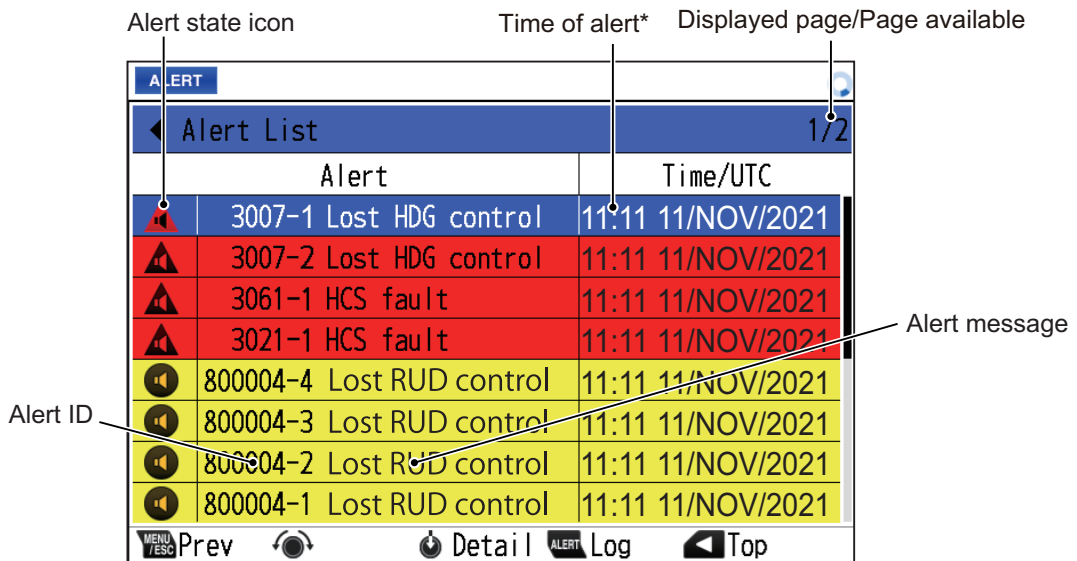

*: The date and time of alert is synchronized with UTC, using the ZDA sentence or NMEA 2000 PGN (126992 or 129033). If the data source is lost, the date and time cannot be synchronized with UTC.

The background color changes according to the alert state as follows.

Unacknowledged alert (flashing display): Alarm, red; Warning, yellow-orange
Acknowledged alert (steady display): Alarm, red; Warning, Yellow-orange; Caution, Indication yellow

Key operation in the [Alert List] window

- **MENU/ESC** key: Closes the [Alert List] window.
- **Course control** knob: You can find detailed information about an alert. Rotate the knob to place the cursor on the alert, then push the knob.

	Alert priority	Alert ID	Alert message
	Caution	3059-1	HCS unavailable
Time of alert	11:11	11/NOV/2021	
Reason for alert	No heading signal.		

- **ALERT** key: Opens the [Alert Log] window.
- **PORT** key: Moves to the first page of the [Alert List] window.

3.5 Alert Log

The [Alert Log] window stores and displays the latest 100 alerts.

To show the alert log, do one of following:

- Key operation: Press the **ALERT** key to show the [Alert List] window, then press the **ALERT** key again.
- Menu operation: Open the user menu, then select [Alert] → [Alert Log].

	Alert priority	Alert ID	Alert message	Time of alert	Displayed page/Pages available
ALERT					
◀ Alert Log					1/11
	Alert			Time/UTC	
1	Caution	800011	System PWR fail	11:11 11/NOV/2021	
2	Warning	800004-4	Lost RUD control	11:11 11/NOV/2021	
3	Warning	800004-3	Lost RUD control	11:11 11/NOV/2021	
4	Warning	800004-2	Lost RUD control	11:11 11/NOV/2021	
MENU/ESC	Prev		Detail	ALERT List	Top

Key operation in the [Alert Log] window

- **MENU/ESC** key: Closes the [Alert Log] window.
- **Course control** knob: You can find detailed information about an alert. Rotate the knob to place the cursor on the alert, then push the knob.
- **ALERT** key: Opens the [Alert List] window.
- **PORT** key: Moves to the first page of the [Alert Log] window.

3.6 Alert Reception from Connected Sensors

An “ALF receive and ACN transmit” communication is available for every serial line input. The ALF message from the sensor includes information about alerts from the sensor, and is presented through the normal alert system. When you acknowledge an alert, an ACN message is sent to the sensor for remote acknowledge.

This interface is based on IEC 61162-1 and IEC 80/520/INF.

4. HOW TO CUSTOMIZE YOUR NAVPILOT

This chapter provides menu operating information on the user menus not previously explained in this manual.

4.1 How to Adjust the Key Beep Volume

When a key is pressed, the control unit can release a beep sound. To turn on/off the key beep, do as follows:

1. Open the user menu.
2. Select [System].
3. Select [Key Volume].
4. Select [High], [Middle], [Low] or [OFF].
5. Close the user menu.

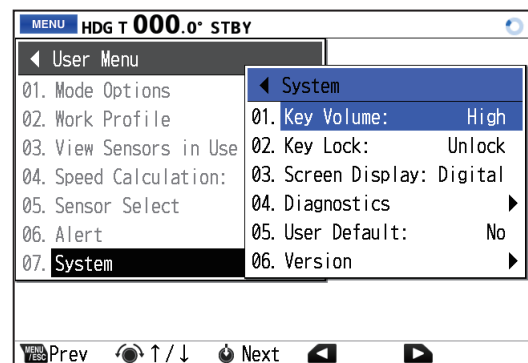

Note: The figure above is display example for the IMO type.

4.2 How to Adjust the Buzzer Volume (non-IMO type only)

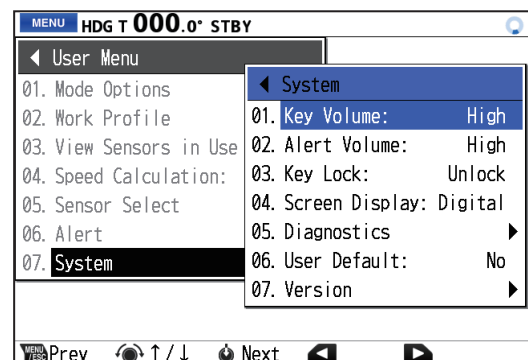

The buzzer that sounds for an alarm or warning alert can be changed. Do as follows to change the volume.

1. Open the user menu.
2. Select [System].
3. Select [Alert Volume].
4. Select [High], [Middle] or [Low].
5. Close the user menu.



4.3 How to Activate the Key Lock Function

You can lock the keys to prevent accidental operation.

1. Open the user menu.
2. Select [System].
3. Select [Key Lock].
4. Select [Lock] or [Unlock].
 - [Lock]: Keys are locked. The lock icon () also appears. When any key, other than the **Power** key (), is pressed, the message shown to the right appears. To unlock the controls, press and hold the **MENU/ESC** key, then press the **STBD** key (). If the system is turned off with the key lock activated, the key lock will be active at the next power-up.
 - [Unlock]: Keys are not locked.
5. Close the user menu.

This controller is locked.
To unlock, hold [menu] key down and press [>] key.

4.4 How to Change the Display Format

The Autopilot main screen can show information in graphical or digital format.

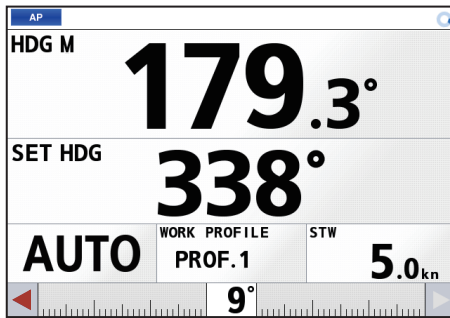

Example: [Screen Display] = [Digital]

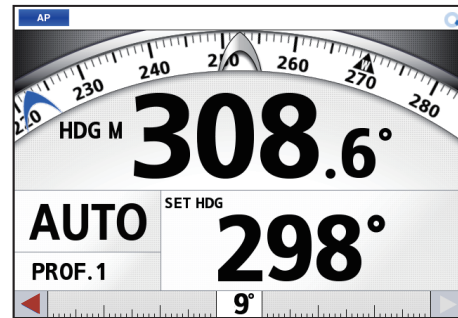

Example: [Screen Display] = [Graphic]

1. Open the user menu.
2. Select [System].
3. Select [Screen Display].
4. Select [Graphic] or [Digital].

When [Graphic] is selected, the arrow mark of the compass indication changes as follows:

 - When [Compass Display] is set to [Heading Up] (at installation), the compass rotates to keep the ship's heading (gray pointer) at the top of the display.
 - When [Compass Display] is set to [Course Up] (at installation), the compass rotates to keep the set course (blue pointer) at the top of the display.
5. Close the user menu.

4.5 How to Show the Software Version

You can check the software versions for the processor unit and control unit.

1. Open the user menu.
2. Select [System].
3. Select [Version].
4. After checking the software version, press the **MENU/ESC** key to close the [Version] window.
5. Close the user menu.

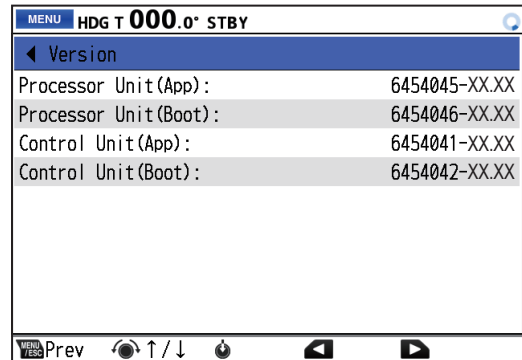

4.6 Installation Menu

Menu items which require service level access are shown in the [Installation Menu]. Several initial settings must be done from this menu. For details, see the Installation Manual.

4. HOW TO CUSTOMIZE YOUR NAVPILOT

This page is intentionally left blank.

5. MAINTENANCE

This chapter provides the user maintenance and troubleshooting procedures.

 **WARNING**

 **ELECTRICAL SHOCK HAZARD**
Do not open the equipment.

This equipment uses high voltage that can cause electrical shock. Only qualified persons can work inside the equipment.

NOTICE

Do not apply paint, anti-corrosive sealant or contact spray to plastic parts or equipment coating.

Those items contain products that can damage plastic parts and equipment coating.

5.1 Preventive Maintenance

Regular maintenance is important for maintaining performance. Create a maintenance schedule which includes the items shown below.

Item	Check point	Remedy
Connectors	Check for tight connection.	Tighten loosened connectors.
Cables	Check cables for damage and corrosion.	Replace cables as necessary.
Processor unit, control unit	Dust/dirt on the units.	Use soft, dry cloth to clean the units. For heavy grime, use a cloth moistened with mild detergent to clean the grime, then wipe the unit dry with a separate soft, dry cloth. Do not use acetone, benzine or other solvents as they will damage the unit.
LCD	Dust on the LCD dims picture.	Clean the LCD carefully to prevent damage, with tissue paper and an LCD cleaner. To remove dirt or salt deposits, use an LCD cleaner and wipe slowly with lens paper so as to dissolve the dirt or salt. Change the paper frequently so the salt or dirt will not damage the LCD. Do not use solvents like thinner, acetone or benzine for cleaning.

5.2 Troubleshooting

The troubleshooting table below provides common faults and the remedies with which to restore normal operation.

Problem	Possible cause/solution
The rudder angle indication shows “*9”.	<ul style="list-style-type: none"> • Check the cable connections between the processor unit and the rudder reference unit, referring to “Rudder reference unit connections” in the installation manual. • If the cable connections appear to be correct, contact a FURUNO dealer.
You cannot turn the power on.	<ul style="list-style-type: none"> • Check the cable connections between the system and the power supply (switchboard, etc.), referring to “Power supply” on the installation manual. • Check all cables and connectors for damage. • Check that the battery is within its voltage rating. • The fuse (F1) in the processor unit or control unit may have blown. See "Replacement of Fuse" on page 5-3.
Nothing appears on the screen.	Press the Power key (⏻) several times to adjust the brilliance.
There is no response when a key is pressed.	<ul style="list-style-type: none"> • Check that the control unit is connected to the processor unit correctly. • Check all cables and connections for damage. • Turn the power off, then on again. If the problem persists, contact a FURUNO dealer for service. <p>If the message “Connecting to Processor Unit...” appears, wait a few minutes for the system to complete the start up process.</p>
Rudder is not responding in AUTO mode.	If a rudder reference unit is installed, have a qualified technician do the rudder limit setup and conduct a rudder calibration. See the Installation Manual for details.
Advanced AUTO mode does not activate.	<ul style="list-style-type: none"> • Check the connections between this system and the connected GPS device. • Check that the GPS device is functioning normally. • Check the settings for data input (see the installation manual).
The compass reading and displayed heading are different.	Compass offset may be required. Contact a FURUNO dealer.
Not receiving NMEA 2000 data.	Check that the NMEA 2000 network is turned on. If the NAVpilot is turned on before the NMEA 2000 network, restart the NAVpilot.
“CAN-bus PWR fail” alert occurs repeatedly.	If four or more control units are connected without the power isolator, power failure occurs due to the collision of the power supply, and “CAN-bus PWR fail” alert occurs. When “CAN-bus PWR fail” alert occurs repeatedly, have a qualified technician check the power connection.

5.3 Replacement of Fuse

Fuses are located in the processor unit. Each fuse protects their electrical circuitry from burning by over-current or equipment fault. If the processor unit, solenoid or by-pass/clutch cannot be powered, a fuse may have blown. Have a qualified technician check the unit or contact a FURUNO dealer.



WARNING

Use the proper fuse.

Use of the wrong fuse can cause fire or electrical shock.

Type	Code no.	Location
Processor unit		
FGMB-S 250V 10A PBF	000-157-495-10	F1
FGMB-A 250V 5A PBF	000-157-570-10	F2, F3, F4, F5
Control unit		
FGMB-A 250V 2A PBF	000-157-497-10	F1

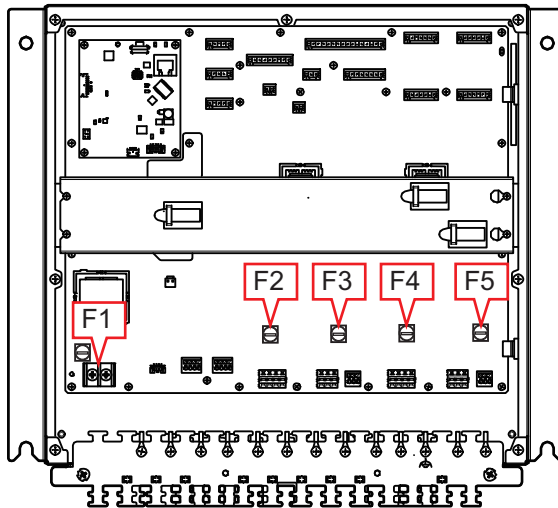

Processor unit

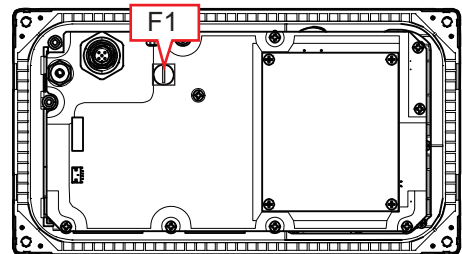

Control unit

5.4 How to View the Sensors in Use

The [View Sensors in Use] display provides a comprehensive list of the sensors connected to your NAVpilot.

1. Open the user menu.
2. Select [View Sensors in Use].

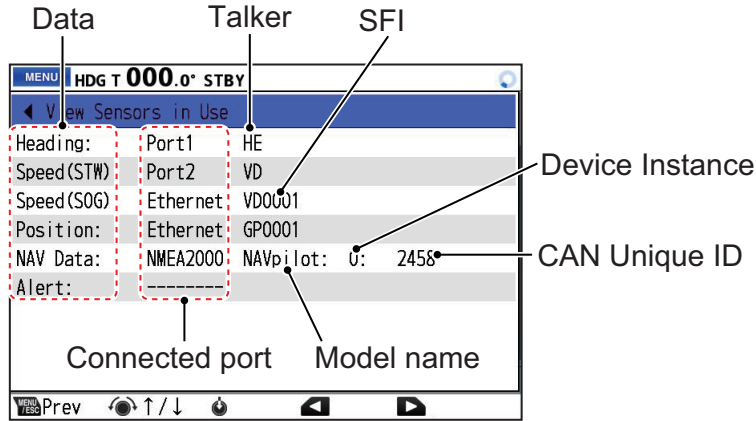

The display shows the source for each data and the equipment identifier number. Dashed lines indicate no connection or sensor is not currently active.

- NMEA 0183 port is used: Port number and talker are shown.
 - NMEA 2000 port is used: Port name, model name, device instance and CAN unique ID are shown.
 - LAN port is used: Port name, model name and IP address are shown.
3. Press the **MENU/ESC** key to close the [View Sensors in Use] display.
 4. Close the user menu.

5.5 Diagnostics

The tests on the Diagnostics menu check if your NAVpilot works properly. The tests are for use by a qualified technician, but you can do the tests to help the technician in troubleshooting.

5.5.1 Processor unit test

This test checks the processor unit for correct operation.

1. Open the user menu.
2. Select [System].
3. Select [Diagnostics].

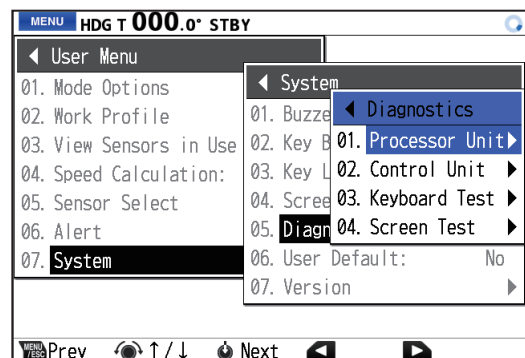

4. Select [Processor Unit].

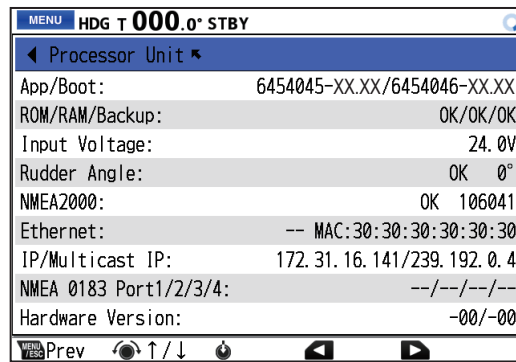

Test item	Description
App/Boot	Shows the application and boot program version number.
ROM/RAM/Backup	Shows the status for ROM, RAM and the Backup.
Input Voltage	Shows the input voltage.
Rudder Angle	Shows the current rudder angle. Shows "OK" when the angle within the rudder limit. If not, "NG" is shown and the rudder angle is not shown.
NMEA2000	Shows the check result of the NMEA 2000 port (OK/NG) and CAN unique ID.
Ethernet	Shows the check result* of the IEC61162-450 port and MAC address. *: Normally, "--" appears.
IP/Multicast IP	Shows the IP address and multicast IP address.
NMEA0183 Port1/2/3/4	Shows the check result* of the NMEA 0183 port 1 to 4. *: Normally, "--" appears.
Hardware Version	Shows the hardware version number.

5. Press the **MENU/ESC** key to close the test result.
6. Close the user menu.

5.5.2 Control unit test

This test checks the control unit for correct operation.

1. Open the user menu.
2. Select [System].
3. Select [Diagnostics].
4. Select [Control Unit].

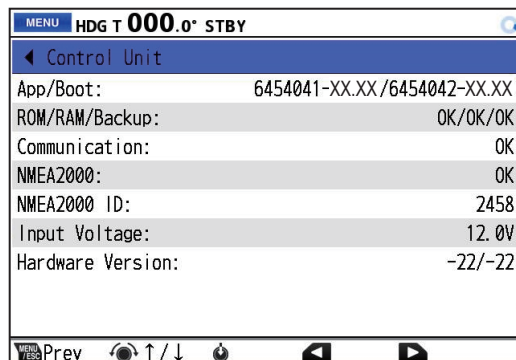

Test item	Description
App/Boot/	Shows the application and boot program version number.
ROM/RAM/Backup	Shows the status for ROM, RAM and the Backup.
Communication	Shows the check result of the communication test with the processor unit.
NMEA2000	Shows the check result of the NMEA 2000 port (OK/NG).
NMEA2000 ID	Shows the CAN unique ID.
Input Voltage	Shows the input voltage.
Hardware Versiion	Shows hardware version number.

5. Press the **MENU/ESC** key to close the test result.
6. Close the user menu.

5.5.3 Keyboard test

The keyboard test checks the key panel on the control unit.

1. Open the user menu.
2. Select [System].
3. Select [Diagnostics].
4. Select [Keyboard Test].

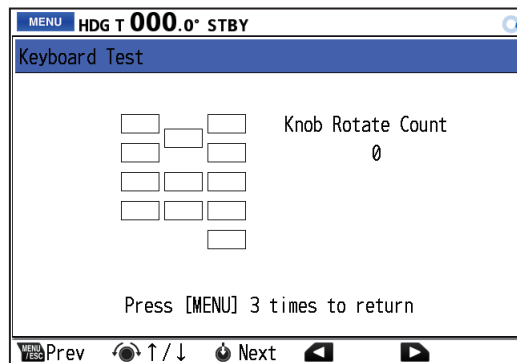

Press each key. The related on-screen location fills in blue if the key is operating normally. Rotate the **Course control** knob. The value on the right of the test screen counts up or down with knob rotation. When the **Course control** knob is pushed, a continuous beep sounds. To stop the beep, push the knob again.

5. Press the **MENU/ESC** key three times to close the test result.
6. Close the user menu.

5.5.4 Screen test

The screen test checks the LCD for proper display of colors.

1. Open the user menu.
2. Select [System].
3. Select [Diagnostics].
4. Select [Screen Test].
5. Press the **STBD** key to cycle through the screens in following order. The **PORT** key cycles through the screens in reverse order.



6. Press the **MENU/ESC** key to close the test result.
7. Close the user menu.

5.6 How to Restore All User Menus to Factory Default

To restore all menu items on the user menu to factory default, do as follows:

1. Open the user menu.
2. Select [System].
3. Select [User Default].
4. Select [Yes].
The following confirmation message appears.

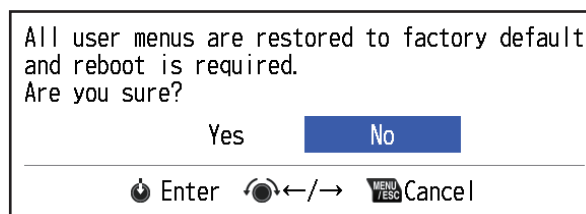

5. Select [Yes] to restore all user menus to factory default. To cancel, select [No]. After selecting [Yes], the NAVpilot reboots automatically and restore factory defaults.

5. MAINTENANCE

This page is intentionally left blank.

APPX. 1 MENU TREE

MENU/ESC key (long press)

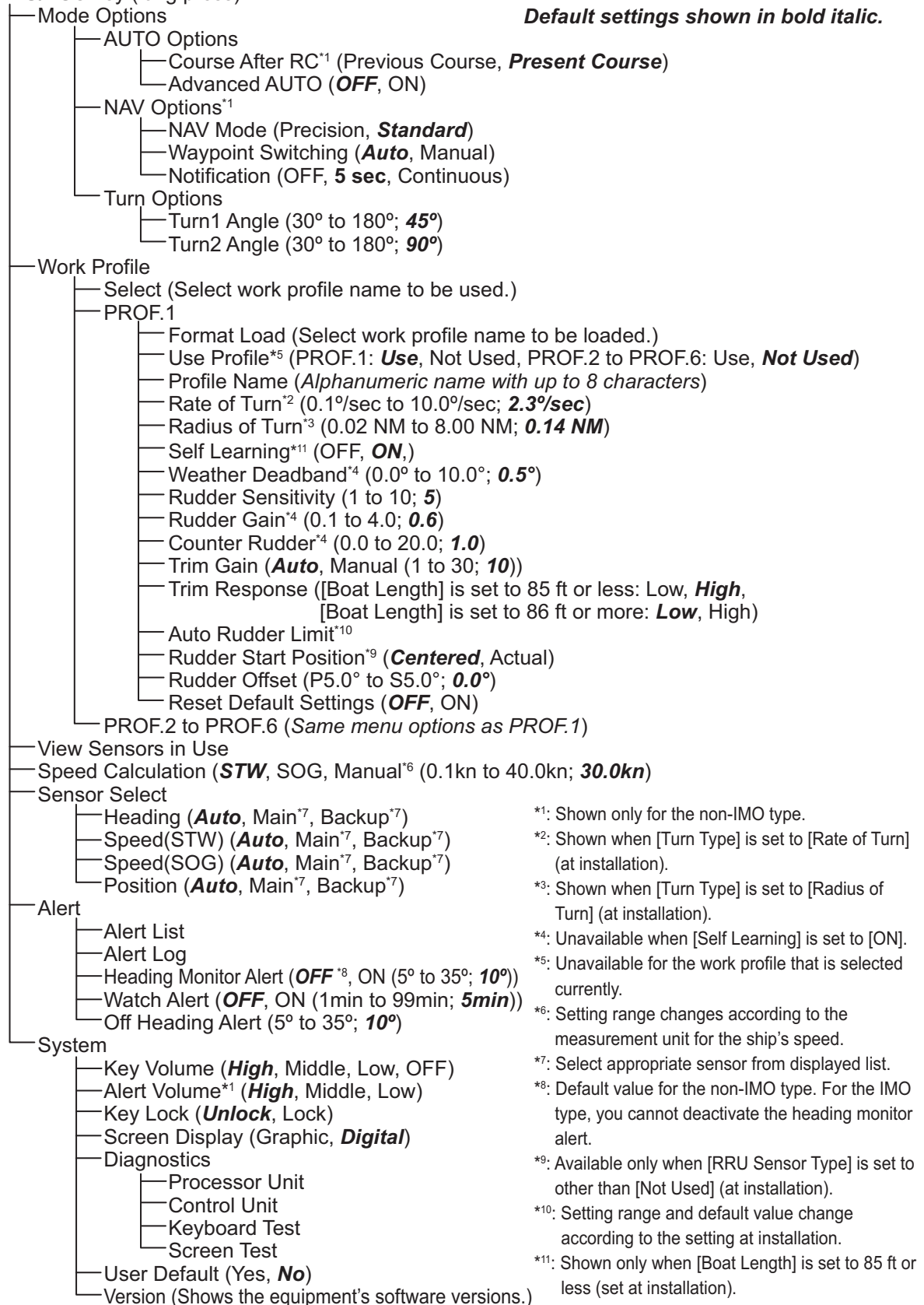

*1: Shown only for the non-IMO type.
 *2: Shown when [Turn Type] is set to [Rate of Turn] (at installation).
 *3: Shown when [Turn Type] is set to [Radius of Turn] (at installation).
 *4: Unavailable when [Self Learning] is set to [ON].
 *5: Unavailable for the work profile that is selected currently.
 *6: Setting range changes according to the measurement unit for the ship's speed.
 *7: Select appropriate sensor from displayed list.
 *8: Default value for the non-IMO type. For the IMO type, you cannot deactivate the heading monitor alert.
 *9: Available only when [RRU Sensor Type] is set to other than [Not Used] (at installation).
 *10: Setting range and default value change according to the setting at installation.
 *11: Shown only when [Boat Length] is set to 85 ft or less (set at installation).

APPX. 2 ALERT LIST

Alerts which are not acknowledged within the specified time limit are repeated as warning level, with the exception of the Alert “Off-heading”. The Alert “Off-heading” is escalated from warning level to alarm level if the alert is not acknowledged within the time limit.

The table below lists the possible alerts for this autopilot. Each alert is listed with priority and category.

Alert ID/ Instance ID	Alert title	Alert Message	Priority & Category	Mode in which alert is generated
3061-1	HCS fault	System power fail. Switch to Manual.	Alarm Cat: B	AUTO Advanced AUTO NAV
	Meaning: Input power voltage of the processor unit is out of threshold. Remedy: Turn the system off and check the power supply voltage to the NAVpilot.			
3061-2	HCS fault	Rudder drive circuit error. Switch to MAN.	Alarm Cat: B	AUTO Advanced AUTO NAV
	Meaning: A malfunction is detected in the rudder drive unit. Remedy: Turn the system off and request service from your local dealer.			
3061-3	HCS fault	Rudder not moving. Switch to Manual.	Alarm Cat: B	AUTO Advanced AUTO NAV
	Meaning: The rudder angle did not follow the rudder order from the NAVpilot. Remedy: If the problem recurs, request service from your local dealer.			
3061-4	HCS fault	Rud. angle HW limit reached. Switch to MAN.	Alarm Cat: B	AUTO Advanced AUTO NAV
	Meaning: The rudder angle reached its hardware limit. Remedy: Stop using the NAVpilot and check the rudder angle, status of the rudder, or hardware limit switch.			
3061-5	HCS fault	Rudder angle limit exceeded. Switch to MAN.	Alarm Cat: B	AUTO Advanced AUTO NAV
	Meaning: Input rudder angle is outside operable threshold. Remedy: Check the connection to, and status of, the rudder angle sensor. If the problem recurs, request service from your local dealer.			
3061-6	HCS fault	Rudder ready signal error. Switch to MAN.	Alarm Cat: B	AUTO Advanced AUTO NAV
	Meaning: The handshake signal response could not be obtained from the steering system. Remedy: Check connection to, and status of, the steering system.			
3061-7	HCS fault	CAN-bus power fail. Switch to Manual.	Alarm Cat: B	AUTO Advanced AUTO NAV
	Meaning: Power supply to the CAN bus network is outside operable threshold. Remedy: Check the voltage from the power supply to the CAN bus network.			

Alert ID/ Instance ID	Alert title	Alert Message	Priority & Category	Mode in which alert is generated
3061-8	HCS fault	Lost all disp unit comm. Switch to Manual.	Alarm Cat: B	AUTO Advanced AUTO NAV
	Meaning: Communication error between the processor unit and control unit. Remedy: Check the connection between the processor unit and control unit.			
3007-1	Lost HDG control	Lost heading signal. Switch to Manual.	Alarm Cat: B	AUTO Advanced AUTO NAV Auto Tuning
	Meaning: The NAVpilot has stopped controlling the rudder due to no heading signal. Remedy: Check connection to, and status of, the heading sensor.			
3007-2	Lost HDG control	HDG data change too large. Switch to MAN.	Alarm Cat: B	AUTO Advanced AUTO NAV Auto Tuning
	Meaning: A sudden change in the heading data was detected. Remedy: Check the status of the heading sensor.			
3059-1	HCS unavailable	No heading signal.	Caution Cat: B	STBY DISENGAGED FU/NFU RC-FU/RC-NFU
	Meaning: The NAVpilot can not use automatic rudder control due to no heading signal. Remedy: Check connection to, and status of, the heading sensor.			
3059-2	HCS unavailable	Rudder drive circuit error.	Caution Cat: B	STBY DISENGAGED Rudder Calibration
	Meaning: A malfunction is detected in the rudder drive unit. Remedy: Turn the system off and request service from your local dealer.			
3059-3	HCS unavailable	Lost all display unit commu- nications.	Caution Cat: B	STBY DISENGAGED Rudder Calibration
	Meaning: Communication error between processor unit and the last control unit. Remedy: Check the connection between the processor unit and control unit. To rectify the alert, a system reboot is required.			
3024	Off-heading	Yawing is too large. Switch to Manual.	Alarm Cat: B	AUTO Advanced AUTO NAV Auto Tuning
	Meaning: Heading deviation is outside operable threshold. Remedy: Check that the control parameters (ex. Rudder Gain/Rud. Counter) are appropriate. If the effect of disturbance is significant, consider switching to manual steering.			
3025	Off-heading	Yawing is too large. Switch to Manual.	Warning Cat: B	AUTO Advanced AUTO NAV Auto Tuning
	Meaning: Heading deviation is outside operable threshold. Remedy: Check that the control parameters (ex. Rudder Gain/Rud. Counter) are appropriate. If the effect of disturbance is significant, consider switching to manual steering.			
3012-1	Doubtful heading	Deviation between two HDG sensors exceeded.	Warning Cat: B	AUTO Advanced AUTO NAV
	Meaning: Heading deviation between the main and backup source are outside operable threshold. Remedy: Check the connections to, and status of, the heading sensors.			

APPX. 2 ALERT LIST

Alert ID/ Instance ID	Alert title	Alert Message	Priority & Category	Mode in which alert is generated
3012-2	Doubtful heading	Loss one of two HDG sensors.	Warning Cat: B	AUTO Advanced AUTO NAV
	Meaning: The one of the two heading sensors was lost. Remedy: Check the connections to, and status of, the heading sensors.			
3065	Low speed	Ship's speed is too low for HDG control.	Warning Cat: B	AUTO Advanced AUTO NAV
	Meaning: Speed input is too low for automatic steering control. Remedy: Accelerate the ship's speed to at least 0.3 kn.			
3113	HDG in fallback	HDG lost. Automatic switched to Backup.	Caution Cat: B	STBY DISENGAGED Rudder Calibration
	Meaning: The source of heading data has changed. Remedy: Check the connections to, and status of, heading sensor, or select the appropriate sensor from [Sensor Select].			
3156	No SPD adaptive	Speed adaptive control is not available.	Caution Cat: B	AUTO Advanced AUTO NAV
	Meaning: There is no speed data input. Remedy: Check the connections to, and status of, the speed sensor. It is also possible to set a manual speed temporarily.			
0800001	Lost one disp	Lost communication with one display unit.	Caution Cat: B	AUTO Advanced AUTO NAV STBY DISENGAGED FU/NFU RC-FU/RC-NFU Auto Tuning Rudder Calibration
	Meaning: Communication error between processor unit and a control unit. Remedy: Check the connection between the processor unit and control unit.			
0800002*	Doubtful NAV data	NAV mode parameter error.	Warning Cat: B	NAV
	Meaning: There is no NAV data input. Remedy: Check the status of the sensor used as NAV data source.			
0800003*	Doubtful Mag HDG	No compass adjustment data.	Caution Cat: B	AUTO Advanced AUTO NAV Auto Tuning
	Meaning: Compass setting is incomplete or an error in the settings was detected. Remedy: Check and complete compass offsets from [Compass Setup] menu.			
0800004-1	Lost RUD control	System power fail. Take helm.	Warning Cat: B	FU/NFU RC-FU/RC-NFU Auto Tuning
	Meaning: Input power voltage of the processor unit is out of threshold. Remedy: Turn the system off and check the power supply voltage to the NAV/pilot.			
0800004-2	Lost RUD control	Rudder drive circuit error. Take helm.	Warning Cat: B	FU/NFU RC-FU/RC-NFU Auto Tuning
	Meaning: A malfunction is detected in the rudder drive unit. Remedy: Turn the system off and request service from your local dealer.			

Alert ID/ Instance ID	Alert title	Alert Message	Priority & Category	Mode in which alert is generated
0800004-3	Lost RUD control	Rudder not moving. Take helm.	Warning Cat: B	FU/NFU RC-FU/RC-NFU Auto Tuning
	Meaning: Rudder is not responding to the rudder drive. Remedy: Check connections between rudder drive and rudder. If the problem persists, request service from your local dealer.			
0800004-4	Lost RUD control	Rudder angle HW limit reached. Take helm.	Warning Cat: B	FU/NFU RC-FU/RC-NFU Auto Tuning
	Meaning: The rudder angle reached its hardware limit. Remedy: Stop using the NAVpilot and check the rudder angle, status of the rudder, or the hardware limit switch.			
0800004-5	Lost RUD control	Rudder angle limit exceeded. Take helm.	Warning Cat: B	FU/NFU RC-FU/RC-NFU Auto Tuning
	Meaning: Input rudder angle is outside operable threshold. Remedy: Stop using the NAVpilot and check the connections to, and status of, the rudder sensor. If the problem recurs, request service from your local dealer.			
0800004-6	Lost RUD control	Rudder ready signal error. Take helm.	Warning Cat: B	FU/NFU RC-FU/RC-NFU Auto Tuning
	Meaning: The handshake signal response could not be obtained from the steering system. Remedy: Check connection to, and status of, the steering system.			
0800004-7	Lost RUD control	CAN-bus power fail. Take helm.	Warning Cat: B	FU/NFU RC-FU/RC-NFU Auto Tuning
	Meaning: Power supply to the CAN bus network is outside operable threshold. Remedy: Check the voltage of the power supply to the CAN bus network.			
0800004-8	Lost RUD control	Lost all disp unit comm. Take helm.	Warning Cat: B	FU/NFU RC-FU/RC-NFU Auto Tuning
	Meaning: Communication error between processor unit and control unit. Remedy: Check the connection between the processor unit and control unit.			
0800005	Lost RC control	Remote control signal error. Take helm.	Warning Cat: B	RC-FU
	Meaning: Remote control signal is outside operable threshold. Remedy: Check connection to, and status of, the remote controller.			
0800006	RC unavailable	Remote controller not available.	Caution Cat: B	AUTO Advanced AUTO NAV STBY DISENGAGED FU/NFU
	Meaning: Remote controller is unavailable. This message is displayed when the switch is turned on in a steering mode that has a higher priority than the remote controller. Remedy: Switch to STBY mode.			
0800007	Lost position	Last position sensor lost. Check source.	Warning Cat: B	Advanced AUTO
	Meaning: There is no position data input. Remedy: Check the connection to, and status of, the position sensor.			

APPX. 2 ALERT LIST

Alert ID/ Instance ID	Alert title	Alert Message	Priority & Category	Mode in which alert is generated
0800008-1*	Lost NAV control	Last NAV data sensor lost. Switch to MAN.	Alarm Cat: B	NAV
	Meaning: There is no NAV data input. Remedy: Check the status of the sensor used as NAV data source.			
0800008-2*	Lost NAV control	Degradation of NAV data quality.	Alarm Cat: B	NAV
	Meaning: NAV data quality is degraded. Remedy: Check the status of the sensor used as NAV data source.			
0800009	POS in fallback	POS lost. Automatic switched to Backup.	Caution Cat: B	STBY DISENGAGED
	Meaning: The data source for positioning changed. Remedy: Check the connections to, and status of, the position sensor.			
0800010	SPD in fallback	SPD lost. Automatic switched to Backup.	Caution Cat: B	STBY DISENGAGED
	Meaning: The data source for speed (SOG/STW) changed. Remedy: Check the connections to, and status of, speed sensor.			
0800011	System PWR fail	System power fail. Check power supply.	Caution Cat: B	STBY DISENGAGED Rudder Calibration
	Meaning: Input power voltage of the processor unit is outside operable threshold. Remedy: Turn the system off and check the power supply voltage to the NAVpilot.			
0800012	CAN-bus PWR fail	CAN-bus power fail. Check power supply.	Caution Cat: B	STBY DISENGAGED Rudder Calibration
	Meaning: Power supply to the CAN bus network is outside operable threshold. Remedy: Check the power supply voltage to the CAN bus network. If four or more control units are connected without the power isolator, this alert may occur repeatedly. Have a qualified technician check the power connection. To rectify the alert, a system reboot is required.			

*: Shown only for the non-IMO type.

APPX. 3 ABBREVIATIONS

Abbreviation	Meaning
A	Alarm
ACK	Acknowledge
ACN	Alert command
ADV.	Advance
ALF	Alert sentence
AMS	Alert Management System
ANGLE	Angle
AP	Autopilot
APR	April
AUG	August
AUTO	Auto
BNWAS	Bridge Navigational Watch Alarm System
Brill	Brilliance
BTW	Bearing To Waypoint
C	Caution
Calib.	Calibration
COG	Course Over Ground
DB	Dead-band
DEC	December
Dest	Destination
DISENGAGED	Disengaged
E	East
ENTER	Enter
ESC	Escape
FEB	February
FU	Follow Up
ft	Feet
h	Hour
HCS	Heading Control System
HDG	Heading
IAS	Integrated Automation System
INACTIVE	Inactive
JAN	January
JUL	July
JUN	June
km	Kilometer
km/h	Kilometers per hour
kn	Knot
m	Meter
M	Magnetic
Mag.	Magnetic
MAR	March
MAX	Maximum
MAY	May
MENU	Menu

APPX. 3 ABBREVIATIONS

Abbreviation	Meaning
Mid	Middle
MIN	Minimum
MODE	Mode
MP	Maintenance Protocol
MPH	Miles per hour
N	North
NAV	Navigation
NFU	Non-Follow Up
NM	Nautical Mile
NOV	November
OCT	October
P	Port
PGN	Parameter Group Number
PORT	Port
Pos.	Position
PRE.	Precision
Prev	Previous
PROF.	Profile
PROFILE	Profile
RC	Remote Controller
RDY	Ready
REQ	Request
ROT	Rate of Turn
RRU	Rudder Reference Unit
Rud.	Rudder
S	Starboard, South
sec	Second
SEP	September
SET	Set
SFI	System Function ID
SIM	Simulation
SM	Statute Mile
SOG	Speed Over Ground
SPD	Speed
STBD	Starboard
STBY	Standby
STW	Speed Through Water
T	True
TURN	Turn
UTC	Universal Time, Coordinated
Var.	Variation
W	Warning, West
WORK	Work
XTE	Cross Track Error
yd	Yard
°	degree

APPX. 4 TERM OF USE FOR OPEN SOURCE SOFTWARE

This product includes software to be licensed under the BSD, MIT and others. For details about the term of use for these software, see the following descriptions:

- **newlib**

(1) Red Hat Incorporated

Copyright (c) 1994-2009 Red Hat, Inc. All rights reserved.

This copyrighted material is made available to anyone wishing to use, modify, copy, or redistribute it subject to the terms and conditions of the BSD License. This program is distributed in the hope that it will be useful, but WITHOUT ANY WARRANTY expressed or implied, including the implied warranties of MERCHANTABILITY or FITNESS FOR A PARTICULAR PURPOSE. A copy of this license is available at <http://www.opensource.org/licenses>. Any Red Hat trademarks that are incorporated in the source code or documentation are not subject to the BSD License and may only be used or replicated with the express permission of Red Hat, Inc.

(2) University of California, Berkeley

Copyright (c) 1981-2000 The Regents of the University of California.

All rights reserved.

Redistribution and use in source and binary forms, with or without modification, are permitted provided that the following conditions are met:

- * Redistributions of source code must retain the above copyright notice, this list of conditions and the following disclaimer.
- * Redistributions in binary form must reproduce the above copyright notice, this list of conditions and the following disclaimer in the documentation and/or other materials provided with the distribution.
- * Neither the name of the University nor the names of its contributors may be used to endorse or promote products derived from this software without specific prior written permission.

THIS SOFTWARE IS PROVIDED BY THE COPYRIGHT HOLDERS AND CONTRIBUTORS "AS IS" AND ANY EXPRESS OR IMPLIED WARRANTIES, INCLUDING, BUT NOT LIMITED TO, THE IMPLIED WARRANTIES OF MERCHANTABILITY AND FITNESS FOR A PARTICULAR PURPOSE ARE DISCLAIMED. IN NO EVENT SHALL THE COPYRIGHT OWNER OR CONTRIBUTORS BE LIABLE FOR ANY DIRECT, INDIRECT, INCIDENTAL, SPECIAL, EXEMPLARY, OR CONSEQUENTIAL DAMAGES (INCLUDING, BUT NOT LIMITED TO, PROCUREMENT OF SUBSTITUTE GOODS OR SERVICES; LOSS OF USE, DATA, OR PROFITS; OR BUSINESS INTERRUPTION) HOWEVER CAUSED AND ON ANY THEORY OF LIABILITY, WHETHER IN CONTRACT, STRICT LIABILITY, OR TORT (INCLUDING NEGLIGENCE OR OTHERWISE) ARISING IN ANY WAY OUT OF THE USE OF THIS SOFTWARE, EVEN IF ADVISED OF THE POSSIBILITY OF SUCH DAMAGE.

(3) David M. Gay (AT&T 1991, Lucent 1998)

The author of this software is David M. Gay.

Copyright (c) 1991 by AT&T.

APPX. 4 TERM OF USE FOR OPEN SOURCE SOFTWARE

Permission to use, copy, modify, and distribute this software for any purpose without fee is hereby granted, provided that this entire notice is included in all copies of any software which is or includes a copy or modification of this software and in all copies of the supporting documentation for such software.

THIS SOFTWARE IS BEING PROVIDED "AS IS", WITHOUT ANY EXPRESS OR IMPLIED WARRANTY. IN PARTICULAR, NEITHER THE AUTHOR NOR AT&T MAKES ANY REPRESENTATION OR WARRANTY OF ANY KIND CONCERNING THE MERCHANTABILITY OF THIS SOFTWARE OR ITS FITNESS FOR ANY PARTICULAR PURPOSE.

The author of this software is David M. Gay.

Copyright (C) 1998-2001 by Lucent Technologies
All Rights Reserved

Permission to use, copy, modify, and distribute this software and its documentation for any purpose and without fee is hereby granted, provided that the above copyright notice appear in all copies and that both that the copyright notice and this permission notice and warranty disclaimer appear in supporting documentation, and that the name of Lucent or any of its entities not be used in advertising or publicity pertaining to distribution of the software without specific, written prior permission.

LUCENT DISCLAIMS ALL WARRANTIES WITH REGARD TO THIS SOFTWARE, INCLUDING ALL IMPLIED WARRANTIES OF MERCHANTABILITY AND FITNESS. IN NO EVENT SHALL LUCENT OR ANY OF ITS ENTITIES BE LIABLE FOR ANY SPECIAL, INDIRECT OR CONSEQUENTIAL DAMAGES OR ANY DAMAGES WHATSOEVER RESULTING FROM LOSS OF USE, DATA OR PROFITS, WHETHER IN AN ACTION OF CONTRACT, NEGLIGENCE OR OTHER TORTIOUS ACTION, ARISING OUT OF OR IN CONNECTION WITH THE USE OR PERFORMANCE OF THIS SOFTWARE.

(4) Advanced Micro Devices

Copyright 1989, 1990 Advanced Micro Devices, Inc.

This software is the property of Advanced Micro Devices, Inc (AMD) which specifically grants the user the right to modify, use and distribute this software provided this notice is not removed or altered. All other rights are reserved by AMD.

AMD MAKES NO WARRANTY OF ANY KIND, EXPRESS OR IMPLIED, WITH REGARD TO THIS SOFTWARE. IN NO EVENT SHALL AMD BE LIABLE FOR INCIDENTAL OR CONSEQUENTIAL DAMAGES IN CONNECTION WITH OR ARISING FROM THE FURNISHING, PERFORMANCE, OR USE OF THIS SOFTWARE.

So that all may benefit from your experience, please report any problems or suggestions about this software to the 29K Technical Support Center at 800-29-29-AMD (800-292-9263) in the USA, or 0800-89-1131 in the UK, or 0031-11-1129 in Japan, toll free. The direct dial number is 512-462-4118.

Advanced Micro Devices, Inc.
29K Support Products
Mail Stop 573
5900 E. Ben White Blvd.
Austin, TX 78741
800-292-9263

(7) Sun Microsystems

Copyright (C) 1993 by Sun Microsystems, Inc. All rights reserved.

Developed at SunPro, a Sun Microsystems, Inc. business. Permission to use, copy, modify, and distribute this software is freely granted, provided that this notice is preserved.

(8) Hewlett Packard

(c) Copyright 1986 HEWLETT-PACKARD COMPANY

To anyone who acknowledges that this file is provided "AS IS" without any express or implied warranty:

permission to use, copy, modify, and distribute this file for any purpose is hereby granted without fee, provided that the above copyright notice and this notice appears in all copies, and that the name of Hewlett-Packard Company not be used in advertising or publicity pertaining to distribution of the software without specific, written prior permission. Hewlett-Packard Company makes no representations about the suitability of this software for any purpose.

(9) Hans-Peter Nilsson

Copyright (C) 2001 Hans-Peter Nilsson

Permission to use, copy, modify, and distribute this software is freely granted, provided that the above copyright notice, this notice and the following disclaimer are preserved with no changes.

THIS SOFTWARE IS PROVIDED ``AS IS" AND WITHOUT ANY EXPRESS OR IMPLIED WARRANTIES, INCLUDING, WITHOUT LIMITATION, THE IMPLIED WARRANTIES OF MERCHANTABILITY AND FITNESS FOR A PARTICULAR PURPOSE.

(11) Christopher G. Demetriou

Copyright (c) 2001 Christopher G. Demetriou
All rights reserved.

1. Redistributions of source code must retain the above copyright notice, this list of conditions and the following disclaimer.
2. Redistributions in binary form must reproduce the above copyright notice, this list of conditions and the following disclaimer in the documentation and/or other materials provided with the distribution.
3. The name of the author may not be used to endorse or promote products derived from this software without specific prior written permission.

THIS SOFTWARE IS PROVIDED BY THE AUTHOR ``AS IS" AND ANY EXPRESS OR IMPLIED WARRANTIES, INCLUDING, BUT NOT LIMITED TO, THE IMPLIED WARRANTIES OF MERCHANTABILITY AND FITNESS FOR A PARTICULAR PURPOSE ARE DISCLAIMED. IN NO EVENT SHALL THE AUTHOR BE LIABLE FOR ANY DIRECT, INDIRECT, INCIDENTAL, SPECIAL, EXEMPLARY, OR CONSEQUENTIAL DAMAGES (INCLUDING, BUT NOT LIMITED TO, PROCUREMENT OF SUBSTITUTE GOODS OR SERVICES; LOSS OF USE, DATA, OR PROFITS; OR BUSINESS INTERRUPTION) HOWEVER CAUSED AND ON ANY THEORY OF LIABILITY, WHETHER IN CONTRACT, STRICT LIABILITY, OR TORT (INCLUDING NEGLIGENCE OR OTHERWISE) ARISING IN ANY WAY OUT OF THE USE OF THIS SOFTWARE, EVEN IF ADVISED OF THE POSSIBILITY OF SUCH DAMAGE.

(12) SuperH, Inc.

Copyright 2002 SuperH, Inc. All rights reserved

This software is the property of SuperH, Inc (SuperH) which specifically grants the user the right to modify, use and distribute this software provided this notice is not removed or altered. All other rights are reserved by SuperH.

SUPERH MAKES NO WARRANTY OF ANY KIND, EXPRESS OR IMPLIED, WITH REGARD TO THIS SOFTWARE. IN NO EVENT SHALL SUPERH BE LIABLE FOR INDIRECT, SPECIAL, INCIDENTAL OR CONSEQUENTIAL DAMAGES IN CONNECTION WITH OR ARISING FROM THE FURNISHING, PERFORMANCE, OR USE OF THIS SOFTWARE.

So that all may benefit from your experience, please report any problems or suggestions about this software to the SuperH Support Center via e-mail at softwaresupport@superh.com..

SuperH, Inc.
405 River Oaks Parkway
San Jose
CA 95134
USA

(13) Royal Institute of Technology

Copyright (c) 1999 Kungliga Tekniska Högskolan
(Royal Institute of Technology, Stockholm, Sweden).
All rights reserved.

Redistribution and use in source and binary forms, with or without modification, are permitted provided that the following conditions are met:

1. Redistributions of source code must retain the above copyright notice, this list of conditions and the following disclaimer.
2. Redistributions in binary form must reproduce the above copyright notice, this list of conditions and the following disclaimer in the documentation and/or other materials provided with the distribution.
3. Neither the name of KTH nor the names of its contributors may be used to endorse or promote products derived from this software without specific prior written permission.

THIS SOFTWARE IS PROVIDED BY KTH AND ITS CONTRIBUTORS "AS IS" AND ANY EXPRESS OR IMPLIED WARRANTIES, INCLUDING, BUT NOT LIMITED TO, THE IMPLIED WARRANTIES OF MERCHANTABILITY AND FITNESS FOR A PARTICULAR PURPOSE ARE DISCLAIMED. IN NO EVENT SHALL KTH OR ITS CONTRIBUTORS BE LIABLE FOR ANY DIRECT, INDIRECT, INCIDENTAL, SPECIAL, EXEMPLARY, OR CONSEQUENTIAL DAMAGES (INCLUDING, BUT NOT LIMITED TO, PROCUREMENT OF SUBSTITUTE GOODS OR SERVICES; LOSS OF USE, DATA, OR PROFITS; OR BUSINESS INTERRUPTION) HOWEVER CAUSED AND ON ANY THEORY OF LIABILITY, WHETHER IN CONTRACT, STRICT LIABILITY, OR TORT (INCLUDING NEGLIGENCE OR OTHERWISE) ARISING IN ANY WAY OUT OF THE USE OF THIS SOFTWARE, EVEN IF ADVISED OF THE POSSIBILITY OF SUCH DAMAGE.

(14) Alexey Zelkin

Copyright (c) 2000, 2001 Alexey Zelkin <phantom@FreeBSD.org>
All rights reserved.

Redistribution and use in source and binary forms, with or without modification, are permitted provided that the following conditions are met:

1. Redistributions of source code must retain the above copyright notice, this list of conditions and the following disclaimer.
2. Redistributions in binary form must reproduce the above copyright notice, this list of conditions and the following disclaimer in the documentation and/or other materials provided with the distribution.

THIS SOFTWARE IS PROVIDED BY THE AUTHOR AND CONTRIBUTORS "AS IS" AND ANY EXPRESS OR IMPLIED WARRANTIES, INCLUDING, BUT NOT LIMITED TO, THE IMPLIED WARRANTIES OF MERCHANTABILITY AND FITNESS FOR A PARTICULAR PURPOSE ARE DISCLAIMED. IN NO EVENT SHALL THE AUTHOR OR CONTRIBUTORS BE LIABLE FOR ANY DIRECT, INDIRECT, INCIDENTAL, SPECIAL, EXEMPLARY, OR CONSEQUENTIAL DAMAGES (INCLUDING, BUT NOT LIMITED TO, PROCUREMENT OF SUBSTITUTE GOODS OR SERVICES; LOSS OF USE, DATA, OR PROFITS; OR BUSINESS INTERRUPTION) HOWEVER CAUSED AND ON ANY THEORY OF LIABILITY, WHETHER IN CONTRACT, STRICT LIABILITY, OR TORT (INCLUDING NEGLIGENCE OR OTHERWISE) ARISING IN ANY WAY OUT OF THE USE OF THIS SOFTWARE, EVEN IF ADVISED OF THE POSSIBILITY OF SUCH DAMAGE.

(15) Andrey A. Chernov

Copyright (C) 1997 by Andrey A. Chernov, Moscow, Russia.
All rights reserved.

Redistribution and use in source and binary forms, with or without modification, are permitted provided that the following conditions are met:

1. Redistributions of source code must retain the above copyright notice, this list of conditions and the following disclaimer.
2. Redistributions in binary form must reproduce the above copyright notice, this list of conditions and the following disclaimer in the documentation and/or other materials provided with the distribution.

THIS SOFTWARE IS PROVIDED BY THE AUTHOR "AS IS" AND ANY EXPRESS OR IMPLIED WARRANTIES, INCLUDING, BUT NOT LIMITED TO, THE IMPLIED WARRANTIES OF MERCHANTABILITY AND FITNESS FOR A PARTICULAR PURPOSE ARE DISCLAIMED. IN NO EVENT SHALL THE REGENTS OR CONTRIBUTORS BE LIABLE FOR ANY DIRECT, INDIRECT, INCIDENTAL, SPECIAL, EXEMPLARY, OR CONSEQUENTIAL DAMAGES (INCLUDING, BUT NOT LIMITED TO, PROCUREMENT OF SUBSTITUTE GOODS OR SERVICES; LOSS OF USE, DATA, OR PROFITS; OR BUSINESS INTERRUPTION) HOWEVER CAUSED AND ON ANY THEORY OF LIABILITY, WHETHER IN CONTRACT, STRICT LIABILITY, OR TORT (INCLUDING NEGLIGENCE OR OTHERWISE) ARISING IN ANY WAY OUT OF THE USE OF THIS SOFTWARE, EVEN IF ADVISED OF THE POSSIBILITY OF SUCH DAMAGE.

(16) FreeBSD

Copyright (c) 1997-2002 FreeBSD Project.
All rights reserved.

Redistribution and use in source and binary forms, with or without modification, are permitted provided that the following conditions are met:

1. Redistributions of source code must retain the above copyright notice, this list of conditions and the following disclaimer.
2. Redistributions in binary form must reproduce the above copyright notice, this list of conditions and the following disclaimer in the documentation and/or other materials provided with the distribution.

THIS SOFTWARE IS PROVIDED BY THE AUTHOR AND CONTRIBUTORS "AS IS" AND ANY EXPRESS OR IMPLIED WARRANTIES, INCLUDING, BUT NOT LIMITED TO, THE IMPLIED WARRANTIES OF MERCHANTABILITY AND FITNESS FOR A PARTICULAR PURPOSE ARE DISCLAIMED. IN NO EVENT SHALL THE AUTHOR OR CONTRIBUTORS BE LIABLE FOR ANY DIRECT, INDIRECT, INCIDENTAL, SPECIAL, EXEMPLARY, OR CONSEQUENTIAL DAMAGES (INCLUDING, BUT NOT LIMITED TO, PROCUREMENT OF SUBSTITUTE GOODS OR SERVICES; LOSS OF USE, DATA, OR PROFITS; OR BUSINESS INTERRUPTION) HOWEVER CAUSED AND ON ANY THEORY OF LIABILITY, WHETHER IN CONTRACT, STRICT LIABILITY, OR TORT (INCLUDING NEGLIGENCE OR OTHERWISE) ARISING IN ANY WAY OUT OF THE USE OF THIS SOFTWARE, EVEN IF ADVISED OF THE POSSIBILITY OF SUCH DAMAGE.

(17) S. L. Moshier

Author: S. L. Moshier.

Copyright (c) 1984,2000 S.L. Moshier

Permission to use, copy, modify, and distribute this software for any purpose without fee is hereby granted, provided that this entire notice is included in all copies of any software which is or includes a copy or modification of this software and in all copies of the supporting documentation for such software.

THIS SOFTWARE IS BEING PROVIDED "AS IS", WITHOUT ANY EXPRESS OR IMPLIED WARRANTY. IN PARTICULAR, THE AUTHOR MAKES NO REPRESENTATION OR WARRANTY OF ANY KIND CONCERNING THE MERCHANTABILITY OF THIS SOFTWARE OR ITS FITNESS FOR ANY PARTICULAR PURPOSE.

(18) Citrus Project

Copyright (c)1999 Citrus Project,
All rights reserved.

Redistribution and use in source and binary forms, with or without modification, are permitted provided that the following conditions are met:

1. Redistributions of source code must retain the above copyright notice, this list of conditions and the following disclaimer.
2. Redistributions in binary form must reproduce the above copyright notice, this list of conditions and the following disclaimer in the documentation and/or other materials provided with the distribution.

THIS SOFTWARE IS PROVIDED BY THE AUTHOR AND CONTRIBUTORS "AS IS" AND ANY EXPRESS OR IMPLIED WARRANTIES, INCLUDING, BUT NOT LIMITED TO, THE IMPLIED WARRANTIES OF MERCHANTABILITY AND FITNESS FOR A PARTICULAR PURPOSE ARE DISCLAIMED. IN NO EVENT SHALL THE AUTHOR OR CONTRIBUTORS BE LIABLE FOR ANY DIRECT, INDIRECT, INCIDENTAL, SPECIAL, EXEMPLARY, OR CONSEQUENTIAL DAMAGES (INCLUDING, BUT NOT LIMITED TO, PROCUREMENT OF SUBSTITUTE GOODS OR SERVICES; LOSS OF USE, DATA, OR PROFITS; OR BUSINESS INTERRUPTION) HOWEVER CAUSED AND ON ANY THEORY OF LIABILITY, WHETHER IN CONTRACT, STRICT LIABILITY, OR TORT (INCLUDING NEGLIGENCE OR OTHERWISE) ARISING IN ANY WAY OUT OF THE USE OF THIS SOFTWARE, EVEN IF ADVISED OF THE POSSIBILITY OF SUCH DAMAGE.

(19) Todd C. Miller

Copyright (c) 1998 Todd C. Miller <Todd.Miller@courtesan.com>
All rights reserved.

Redistribution and use in source and binary forms, with or without modification, are permitted provided that the following conditions are met:

1. Redistributions of source code must retain the above copyright notice, this list of conditions and the following disclaimer.
2. Redistributions in binary form must reproduce the above copyright notice, this list of conditions and the following disclaimer in the documentation and/or other materials provided with the distribution.
3. The name of the author may not be used to endorse or promote products derived from this software without specific prior written permission.

THIS SOFTWARE IS PROVIDED ``AS IS" AND ANY EXPRESS OR IMPLIED WARRANTIES, INCLUDING, BUT NOT LIMITED TO, THE IMPLIED WARRANTIES OF MERCHANTABILITY AND FITNESS FOR A PARTICULAR PURPOSE ARE DISCLAIMED. IN NO EVENT SHALL THE AUTHOR BE LIABLE FOR ANY DIRECT, INDIRECT, INCIDENTAL, SPECIAL, EXEMPLARY, OR CONSEQUENTIAL DAMAGES (INCLUDING, BUT NOT LIMITED TO, PROCUREMENT OF SUBSTITUTE GOODS OR SERVICES; LOSS OF USE, DATA, OR PROFITS; OR BUSINESS INTERRUPTION) HOWEVER CAUSED AND ON ANY THEORY OF LIABILITY, WHETHER IN CONTRACT, STRICT LIABILITY, OR TORT (INCLUDING NEGLIGENCE OR OTHERWISE) ARISING IN ANY WAY OUT OF THE USE OF THIS SOFTWARE, EVEN IF ADVISED OF THE POSSIBILITY OF SUCH DAMAGE.

(20) DJ Delorie (i386)

Copyright (C) 1991 DJ Delorie
All rights reserved.

Redistribution, modification, and use in source and binary forms is permitted provided that the above copyright notice and following paragraph are duplicated in all such forms.

This file is distributed WITHOUT ANY WARRANTY; without even the implied warranty of MERCHANTABILITY or FITNESS FOR A PARTICULAR PURPOSE.

(23) Intel (i960)

Copyright (c) 1993 Intel Corporation

Intel hereby grants you permission to copy, modify, and distribute this software and its documentation. Intel grants this permission provided that the above copyright notice appears in all copies and that both the copyright notice and this permission notice appear in supporting documentation. In addition, Intel grants this permission provided that you prominently mark as "not part of the original" any modifications made to this software or documentation, and that the name of Intel Corporation not be used in advertising or publicity pertaining to distribution of the software or the documentation without specific, written prior permission.

Intel Corporation provides this AS IS, WITHOUT ANY WARRANTY, EXPRESS OR IMPLIED, INCLUDING, WITHOUT LIMITATION, ANY WARRANTY OF MERCHANTABILITY OR FITNESS FOR A PARTICULAR PURPOSE. Intel makes no guarantee or representations regarding the use of, or the results of the use of, the software and documentation in terms of correctness, accuracy, reliability, currentness, or otherwise; and you rely on the software, documentation and results solely at your own risk. IN NO EVENT SHALL INTEL BE LIABLE FOR ANY LOSS OF USE, LOSS OF BUSINESS, LOSS OF PROFITS, INDIRECT, INCIDENTAL, SPECIAL OR CONSEQUEN-

TIAL DAMAGES OF ANY KIND. IN NO EVENT SHALL INTEL'S TOTAL LIABILITY EXCEED THE SUM PAID TO INTEL FOR THE PRODUCT LICENSED HEREUNDER.

(26) Mike Barcroft

Copyright (c) 2001 Mike Barcroft <mike@FreeBSD.org>
All rights reserved.

Redistribution and use in source and binary forms, with or without modification, are permitted provided that the following conditions are met:

1. Redistributions of source code must retain the above copyright notice, this list of conditions and the following disclaimer.
2. Redistributions in binary form must reproduce the above copyright notice, this list of conditions and the following disclaimer in the documentation and/or other materials provided with the distribution.

THIS SOFTWARE IS PROVIDED BY THE AUTHOR AND CONTRIBUTORS ``AS IS" AND ANY EXPRESS OR IMPLIED WARRANTIES, INCLUDING, BUT NOT LIMITED TO, THE IMPLIED WARRANTIES OF MERCHANTABILITY AND FITNESS FOR A PARTICULAR PURPOSE ARE DISCLAIMED. IN NO EVENT SHALL THE AUTHOR OR CONTRIBUTORS BE LIABLE FOR ANY DIRECT, INDIRECT, INCIDENTAL, SPECIAL, EXEMPLARY, OR CONSEQUENTIAL DAMAGES (INCLUDING, BUT NOT LIMITED TO, PROCUREMENT OF SUBSTITUTE GOODS OR SERVICES; LOSS OF USE, DATA, OR PROFITS; OR BUSINESS INTERRUPTION) HOWEVER CAUSED AND ON ANY THEORY OF LIABILITY, WHETHER IN CONTRACT, STRICT LIABILITY, OR TORT (INCLUDING NEGLIGENCE OR OTHERWISE) ARISING IN ANY WAY OUT OF THE USE OF THIS SOFTWARE, EVEN IF ADVISED OF THE POSSIBILITY OF SUCH DAMAGE.

(27) Konstantin Chuguev (--enable-newlib-iconv)

Copyright (c) 1999, 2000

Konstantin Chuguev. All rights reserved. Redistribution and use in source and binary forms, with or without modification, are permitted provided that the following conditions are met:

1. Redistributions of source code must retain the above copyright notice, this list of conditions and the following disclaimer.
2. Redistributions in binary form must reproduce the above copyright notice, this list of conditions and the following disclaimer in the documentation and/or other materials provided with the distribution.

THIS SOFTWARE IS PROVIDED BY THE AUTHOR AND CONTRIBUTORS ``AS IS" AND ANY EXPRESS OR IMPLIED WARRANTIES, INCLUDING, BUT NOT LIMITED TO, THE IMPLIED WARRANTIES OF MERCHANTABILITY AND FITNESS FOR A PARTICULAR PURPOSE ARE DISCLAIMED. IN NO EVENT SHALL THE AUTHOR OR CONTRIBUTORS BE LIABLE FOR ANY DIRECT, INDIRECT, INCIDENTAL, SPECIAL, EXEMPLARY, OR CONSEQUENTIAL DAMAGES (INCLUDING, BUT NOT LIMITED TO, PROCUREMENT OF SUBSTITUTE GOODS OR SERVICES; LOSS OF USE, DATA, OR PROFITS; OR BUSINESS INTERRUPTION) HOWEVER CAUSED AND ON ANY THEORY OF LIABILITY, WHETHER IN CONTRACT, STRICT LIABILITY, OR TORT (INCLUDING NEGLIGENCE OR OTHERWISE) ARISING IN ANY WAY OUT OF THE USE OF THIS SOFTWARE, EVEN IF ADVISED OF THE POSSIBILITY OF SUCH DAMAGE.

iconv (Charset Conversion Library) v2.0

(28) Artem Bityuckiy (--enable-newlib-iconv)

Copyright (c) 2003, Artem B. Bityuckiy, SoftMine Corporation.
Rights transferred to Franklin Electronic Publishers.

Redistribution and use in source and binary forms, with or without modification, are permitted provided that the following conditions are met:

1. Redistributions of source code must retain the above copyright notice, this list of conditions and the following disclaimer.
2. Redistributions in binary form must reproduce the above copyright notice, this list of conditions and the following disclaimer in the documentation and/or other materials provided with the distribution.

THIS SOFTWARE IS PROVIDED BY THE AUTHOR AND CONTRIBUTORS ``AS IS" AND ANY EXPRESS OR IMPLIED WARRANTIES, INCLUDING, BUT NOT LIMITED TO, THE IMPLIED WARRANTIES OF MERCHANTABILITY AND FITNESS FOR A PARTICULAR PURPOSE ARE DISCLAIMED. IN NO EVENT SHALL THE AUTHOR OR CONTRIBUTORS BE LIABLE FOR ANY DIRECT, INDIRECT, INCIDENTAL, SPECIAL, EXEMPLARY, OR CONSEQUENTIAL DAMAGES (INCLUDING, BUT NOT LIMITED TO, PROCUREMENT OF SUBSTITUTE GOODS OR SERVICES; LOSS OF USE, DATA, OR PROFITS; OR BUSINESS INTERRUPTION) HOWEVER CAUSED AND ON ANY THEORY OF LIABILITY, WHETHER IN CONTRACT, STRICT LIABILITY, OR TORT (INCLUDING NEGLIGENCE OR OTHERWISE) ARISING IN ANY WAY OUT OF THE USE OF THIS SOFTWARE, EVEN IF ADVISED OF THE POSSIBILITY OF SUCH DAMAGE.

(35) - ARM Ltd (arm and thumb variant targets only)

Copyright (c) 2009-2015 ARM Ltd
All rights reserved.

Redistribution and use in source and binary forms, with or without modification, are permitted provided that the following conditions are met:

1. Redistributions of source code must retain the above copyright notice, this list of conditions and the following disclaimer.
2. Redistributions in binary form must reproduce the above copyright notice, this list of conditions and the following disclaimer in the documentation and/or other materials provided with the distribution.
3. The name of the company may not be used to endorse or promote products derived from this software without specific prior written permission.

THIS SOFTWARE IS PROVIDED BY ARM LTD ``AS IS" AND ANY EXPRESS OR IMPLIED WARRANTIES, INCLUDING, BUT NOT LIMITED TO, THE IMPLIED WARRANTIES OF MERCHANTABILITY AND FITNESS FOR A PARTICULAR PURPOSE ARE DISCLAIMED. IN NO EVENT SHALL ARM LTD BE LIABLE FOR ANY DIRECT, INDIRECT, INCIDENTAL, SPECIAL, EXEMPLARY, OR CONSEQUENTIAL DAMAGES (INCLUDING, BUT NOT LIMITED TO, PROCUREMENT OF SUBSTITUTE GOODS OR SERVICES; LOSS OF USE, DATA, OR PROFITS; OR BUSINESS INTERRUPTION) HOWEVER CAUSED AND ON ANY THEORY OF LIABILITY, WHETHER IN CONTRACT, STRICT LIABILITY, OR TORT (INCLUDING NEGLIGENCE OR OTHERWISE) ARISING IN ANY WAY OUT OF THE USE OF THIS SOFTWARE, EVEN IF ADVISED OF THE POSSIBILITY OF SUCH DAMAGE.

(41) Ed Schouten - Free BSD

Copyright (c) 2008 Ed Schouten <ed@FreeBSD.org>

All rights reserved. Redistribution and use in source and binary forms, with or without modification, are permitted provided that the following conditions are met:

APPX. 4 TERM OF USE FOR OPEN SOURCE SOFTWARE

1. Redistributions of source code must retain the above copyright notice, this list of conditions and the following disclaimer.
2. Redistributions in binary form must reproduce the above copyright notice, this list of conditions and the following disclaimer in the documentation and/or other materials provided with the distribution.

THIS SOFTWARE IS PROVIDED BY THE AUTHOR AND CONTRIBUTORS "AS IS" AND ANY EXPRESS OR IMPLIED WARRANTIES, INCLUDING, BUT NOT LIMITED TO, THE IMPLIED WARRANTIES OF MERCHANTABILITY AND FITNESS FOR A PARTICULAR PURPOSE ARE DISCLAIMED. IN NO EVENT SHALL THE AUTHOR OR CONTRIBUTORS BE LIABLE FOR ANY DIRECT, INDIRECT, INCIDENTAL, SPECIAL, EXEMPLARY, OR CONSEQUENTIAL DAMAGES (INCLUDING, BUT NOT LIMITED TO, PROCUREMENT OF SUBSTITUTE GOODS OR SERVICES; LOSS OF USE, DATA, OR PROFITS; OR BUSINESS INTERRUPTION) HOWEVER CAUSED AND ON ANY THEORY OF LIABILITY, WHETHER IN CONTRACT, STRICT LIABILITY, OR TORT (INCLUDING NEGLIGENCE OR OTHERWISE) ARISING IN ANY WAY OUT OF THE USE OF THIS SOFTWARE, EVEN IF ADVISED OF THE POSSIBILITY OF SUCH DAMAGE.

(46)

Copyright (c) 2016, Synopsys, Inc. All rights reserved.

Redistribution and use in source and binary forms, with or without modification, are permitted provided that the following conditions are met:

- 1) Redistributions of source code must retain the above copyright notice, this list of conditions and the following disclaimer.
- 2) Redistributions in binary form must reproduce the above copyright notice, this list of conditions and the following disclaimer in the documentation and/or other materials provided with the distribution.
- 3) Neither the name of the Synopsys, Inc., nor the names of its contributors may be used to endorse or promote products derived from this software without specific prior written permission.

THIS SOFTWARE IS PROVIDED BY THE COPYRIGHT HOLDERS AND CONTRIBUTORS "AS IS" AND ANY EXPRESS OR IMPLIED WARRANTIES, INCLUDING, BUT NOT LIMITED TO, THE IMPLIED WARRANTIES OF MERCHANTABILITY AND FITNESS FOR A PARTICULAR PURPOSE ARE DISCLAIMED. IN NO EVENT SHALL THE COPYRIGHT HOLDER OR CONTRIBUTORS BE LIABLE FOR ANY DIRECT, INDIRECT, INCIDENTAL, SPECIAL, EXEMPLARY, OR CONSEQUENTIAL DAMAGES (INCLUDING, BUT NOT LIMITED TO, PROCUREMENT OF SUBSTITUTE GOODS OR SERVICES; LOSS OF USE, DATA, OR PROFITS; OR BUSINESS INTERRUPTION) HOWEVER CAUSED AND ON ANY THEORY OF LIABILITY, WHETHER IN CONTRACT, STRICT LIABILITY, OR TORT (INCLUDING NEGLIGENCE OR OTHERWISE) ARISING IN ANY WAY OUT OF THE USE OF THIS SOFTWARE, EVEN IF ADVISED OF THE POSSIBILITY OF SUCH DAMAGE.

(47)

Copyright (c) 2016 Joel Sherrill <joel@rtems.org>. All rights reserved.

Redistribution and use in source and binary forms, with or without modification, are permitted provided that the following conditions are met:

1. Redistributions of source code must retain the above copyright notice, this list of conditions and the following disclaimer.

2. Redistributions in binary form must reproduce the above copyright notice, this list of conditions and the following disclaimer in the documentation and/or other materials provided with the distribution.

THIS SOFTWARE IS PROVIDED BY THE AUTHOR AND CONTRIBUTORS ``AS IS" AND ANY EXPRESS OR IMPLIED WARRANTIES, INCLUDING, BUT NOT LIMITED TO, THE IMPLIED WARRANTIES OF MERCHANTABILITY AND FITNESS FOR A PARTICULAR PURPOSE ARE DISCLAIMED. IN NO EVENT SHALL THE AUTHOR OR CONTRIBUTORS BE LIABLE FOR ANY DIRECT, INDIRECT, INCIDENTAL, SPECIAL, EXEMPLARY, OR CONSEQUENTIAL DAMAGES (INCLUDING, BUT NOT LIMITED TO, PROCUREMENT OF SUBSTITUTE GOODS OR SERVICES; LOSS OF USE, DATA, OR PROFITS; OR BUSINESS INTERRUPTION) HOWEVER CAUSED AND ON ANY THEORY OF LIABILITY, WHETHER IN CONTRACT, STRICT LIABILITY, OR TORT (INCLUDING NEGLIGENCE OR OTHERWISE) ARISING IN ANY WAY OUT OF THE USE OF THIS SOFTWARE, EVEN IF ADVISED OF THE POSSIBILITY OF SUCH DAMAGE.

(48)

From `musl include/elf.h`

Copyright © 2005-2014 Rich Felker, et al.t

Permission is hereby granted, free of charge, to any person obtaining a copy of this software and associated documentation files (the "Software"), to deal in the Software without restriction, including without limitation the rights to use, copy, modify, merge, publish, distribute, sublicense, and/or sell copies of the Software, and to permit persons to whom the Software is furnished to do so, subject to the following conditions:

The above copyright notice and this permission notice shall be included in all copies or substantial portions of the Software.

THE SOFTWARE IS PROVIDED "AS IS", WITHOUT WARRANTY OF ANY KIND, EXPRESS OR IMPLIED, INCLUDING BUT NOT LIMITED TO THE WARRANTIES OF MERCHANTABILITY, FITNESS FOR A PARTICULAR PURPOSE AND NONINFRINGEMENT. IN NO EVENT SHALL THE AUTHORS OR COPYRIGHT HOLDERS BE LIABLE FOR ANY CLAIM, DAMAGES OR OTHER LIABILITY, WHETHER IN AN ACTION OF CONTRACT, TORT OR OTHERWISE, ARISING FROM, OUT OF OR IN CONNECTION WITH THE SOFTWARE OR THE USE OR OTHER DEALINGS IN THE SOFTWARE.

(49)

Copyright (c) 2008 Otto Moerbeek <otto@drijf.net>

Permission to use, copy, modify, and distribute this software for any purpose with or without fee is hereby granted, provided that the above copyright notice and this permission notice appear in all copies.

THE SOFTWARE IS PROVIDED "AS IS" AND THE AUTHOR DISCLAIMS ALL WARRANTIES WITH REGARD TO THIS SOFTWARE INCLUDING ALL IMPLIED WARRANTIES OF MERCHANTABILITY AND FITNESS. IN NO EVENT SHALL THE AUTHOR BE LIABLE FOR ANY SPECIAL, DIRECT, INDIRECT, OR CONSEQUENTIAL DAMAGES OR ANY DAMAGES WHATSOEVER RESULTING FROM LOSS OF USE, DATA OR PROFITS, WHETHER IN AN ACTION OF CONTRACT, NEGLIGENCE OR OTHER TORTIOUS ACTION, ARISING OUT OF OR IN CONNECTION WITH THE USE OR PERFORMANCE OF THIS SOFTWARE.

(50)

Copyright (c) 2017 embedded brains GmbH
All rights reserved.

Redistribution and use in source and binary forms, with or without modification, are permitted provided that the following conditions are met:

1. Redistributions of source code must retain the above copyright notice, this list of conditions and the following disclaimer.
2. Redistributions in binary form must reproduce the above copyright notice, this list of conditions and the following disclaimer in the documentation and/or other materials provided with the distribution.

THIS SOFTWARE IS PROVIDED BY THE AUTHOR AND CONTRIBUTORS ``AS IS" AND ANY EXPRESS OR IMPLIED WARRANTIES, INCLUDING, BUT NOT LIMITED TO, THE IMPLIED WARRANTIES OF MERCHANTABILITY AND FITNESS FOR A PARTICULAR PURPOSE ARE DISCLAIMED. IN NO EVENT SHALL THE AUTHOR OR CONTRIBUTORS BE LIABLE FOR ANY DIRECT, INDIRECT, INCIDENTAL, SPECIAL, EXEMPLARY, OR CONSEQUENTIAL DAMAGES (INCLUDING, BUT NOT LIMITED TO, PROCUREMENT OF SUBSTITUTE GOODS OR SERVICES; LOSS OF USE, DATA, OR PROFITS; OR BUSINESS INTERRUPTION) HOWEVER CAUSED AND ON ANY THEORY OF LIABILITY, WHETHER IN CONTRACT, STRICT LIABILITY, OR TORT (INCLUDING NEGLIGENCE OR OTHERWISE) ARISING IN ANY WAY OUT OF THE USE OF THIS SOFTWARE, EVEN IF ADVISED OF THE POSSIBILITY OF SUCH DAMAGE.

(51)

From `musl src/string/strverscmp.c`

Copyright © 2005-2014 Rich Felker, et al.

Permission is hereby granted, free of charge, to any person obtaining a copy of this software and associated documentation files (the "Software"), to deal in the Software without restriction, including without limitation the rights to use, copy, modify, merge, publish, distribute, sublicense, and/or sell copies of the Software, and to permit persons to whom the Software is furnished to do so, subject to the following conditions:

The above copyright notice and this permission notice shall be included in all copies or substantial portions of the Software.

THE SOFTWARE IS PROVIDED "AS IS", WITHOUT WARRANTY OF ANY KIND, EXPRESS OR IMPLIED, INCLUDING BUT NOT LIMITED TO THE WARRANTIES OF MERCHANTABILITY, FITNESS FOR A PARTICULAR PURPOSE AND NONINFRINGEMENT. IN NO EVENT SHALL THE AUTHORS OR COPYRIGHT HOLDERS BE LIABLE FOR ANY CLAIM, DAMAGES OR OTHER LIABILITY, WHETHER IN AN ACTION OF CONTRACT, TORT OR OTHERWISE, ARISING FROM, OUT OF OR IN CONNECTION WITH THE SOFTWARE OR THE USE OR OTHER DEALINGS IN THE SOFTWARE.

(52)

`++Copyright++ 1983, 1993`

-

Copyright (c) 1983, 1993

The Regents of the University of California. All rights reserved.

Redistribution and use in source and binary forms, with or without modification, are permitted provided that the following conditions are met:

1. Redistributions of source code must retain the above copyright notice, this list of conditions and the following disclaimer.
2. Redistributions in binary form must reproduce the above copyright notice, this list of conditions and the following disclaimer in the documentation and/or other materials provided with the distribution.
3. Neither the name of the University nor the names of its contributors may be used to endorse or promote products derived from this software without specific prior written permission.

THIS SOFTWARE IS PROVIDED BY THE REGENTS AND CONTRIBUTORS ``AS IS" AND ANY EXPRESS OR IMPLIED WARRANTIES, INCLUDING, BUT NOT LIMITED TO, THE IMPLIED WARRANTIES OF MERCHANTABILITY AND FITNESS FOR A PARTICULAR PURPOSE ARE DISCLAIMED. IN NO EVENT SHALL THE REGENTS OR CONTRIBUTORS BE LIABLE FOR ANY DIRECT, INDIRECT, INCIDENTAL, SPECIAL, EXEMPLARY, OR CONSEQUENTIAL DAMAGES (INCLUDING, BUT NOT LIMITED TO, PROCUREMENT OF SUBSTITUTE GOODS OR SERVICES; LOSS OF USE, DATA, OR PROFITS; OR BUSINESS INTERRUPTION) HOWEVER CAUSED AND ON ANY THEORY OF LIABILITY, WHETHER IN CONTRACT, STRICT LIABILITY, OR TORT (INCLUDING NEGLIGENCE OR OTHERWISE) ARISING IN ANY WAY OUT OF THE USE OF THIS SOFTWARE, EVEN IF ADVISED OF THE POSSIBILITY OF SUCH DAMAGE.

-

Portions Copyright (c) 1993 by Digital Equipment Corporation.

Permission to use, copy, modify, and distribute this software for any purpose with or without fee is hereby granted, provided that the above copyright notice and this permission notice appear in all copies, and that the name of Digital Equipment Corporation not be used in advertising or publicity pertaining to distribution of the document or software without specific, written prior permission.

THE SOFTWARE IS PROVIDED "AS IS" AND DIGITAL EQUIPMENT CORP. DISCLAIMS ALL WARRANTIES WITH REGARD TO THIS SOFTWARE, INCLUDING ALL IMPLIED WARRANTIES OF MERCHANTABILITY AND FITNESS. IN NO EVENT SHALL DIGITAL EQUIPMENT CORPORATION BE LIABLE FOR ANY SPECIAL, DIRECT, INDIRECT, OR CONSEQUENTIAL DAMAGES OR ANY DAMAGES WHATSOEVER RESULTING FROM LOSS OF USE, DATA OR PROFITS, WHETHER IN AN ACTION OF CONTRACT, NEGLIGENCE OR OTHER TORTIOUS ACTION, ARISING OUT OF OR IN CONNECTION WITH THE USE OR PERFORMANCE OF THIS SOFTWARE.

-

--Copyright--

(53)

Copyright (c) 2015 John Baldwin <jhb@FreeBSD.org>.
All rights reserved.

Redistribution and use in source and binary forms, with or without modification, are permitted provided that the following conditions are met:

1. Redistributions of source code must retain the above copyright notice, this list of conditions and the following disclaimer.
2. Redistributions in binary form must reproduce the above copyright notice, this list of conditions and the following disclaimer in the documentation and/or other materials provided with the distribution.

3. Neither the name of the author nor the names of its contributors may be used to endorse or promote products derived from this software without specific prior written permission.

THIS SOFTWARE IS PROVIDED BY THE REGENTS AND CONTRIBUTORS ``AS IS" AND ANY EXPRESS OR IMPLIED WARRANTIES, INCLUDING, BUT NOT LIMITED TO, THE IMPLIED WARRANTIES OF MERCHANTABILITY AND FITNESS FOR A PARTICULAR PURPOSE ARE DISCLAIMED. IN NO EVENT SHALL THE REGENTS OR CONTRIBUTORS BE LIABLE FOR ANY DIRECT, INDIRECT, INCIDENTAL, SPECIAL, EXEMPLARY, OR CONSEQUENTIAL DAMAGES (INCLUDING, BUT NOT LIMITED TO, PROCUREMENT OF SUBSTITUTE GOODS OR SERVICES; LOSS OF USE, DATA, OR PROFITS; OR BUSINESS INTERRUPTION) HOWEVER CAUSED AND ON ANY THEORY OF LIABILITY, WHETHER IN CONTRACT, STRICT LIABILITY, OR TORT (INCLUDING NEGLIGENCE OR OTHERWISE) ARISING IN ANY WAY OUT OF THE USE OF THIS SOFTWARE, EVEN IF ADVISED OF THE POSSIBILITY OF SUCH DAMAGE.

(54)

Copyright (C) 1995, 1996, 1997, and 1998 WIDE Project.
All rights reserved.

Redistribution and use in source and binary forms, with or without modification, are permitted provided that the following conditions are met:

1. Redistributions of source code must retain the above copyright notice, this list of conditions and the following disclaimer.
2. Redistributions in binary form must reproduce the above copyright notice, this list of conditions and the following disclaimer in the documentation and/or other materials provided with the distribution.
3. Neither the name of the project nor the names of its contributors may be used to endorse or promote products derived from this software without specific prior written permission.

THIS SOFTWARE IS PROVIDED BY THE PROJECT AND CONTRIBUTORS ``AS IS" AND ANY EXPRESS OR IMPLIED WARRANTIES, INCLUDING, BUT NOT LIMITED TO, THE IMPLIED WARRANTIES OF MERCHANTABILITY AND FITNESS FOR A PARTICULAR PURPOSE ARE DISCLAIMED. IN NO EVENT SHALL THE PROJECT OR CONTRIBUTORS BE LIABLE FOR ANY DIRECT, INDIRECT, INCIDENTAL, SPECIAL, EXEMPLARY, OR CONSEQUENTIAL DAMAGES (INCLUDING, BUT NOT LIMITED TO, PROCUREMENT OF SUBSTITUTE GOODS OR SERVICES; LOSS OF USE, DATA, OR PROFITS; OR BUSINESS INTERRUPTION) HOWEVER CAUSED AND ON ANY THEORY OF LIABILITY, WHETHER IN CONTRACT, STRICT LIABILITY, OR TORT (INCLUDING NEGLIGENCE OR OTHERWISE) ARISING IN ANY WAY OUT OF THE USE OF THIS SOFTWARE, EVEN IF ADVISED OF THE POSSIBILITY OF SUCH DAMAGE.

\$KAME: in6.h,v 1.89 2001/05/27 13:28:35 itojun Exp \$

(55)

Copyright (c) 2008, Jeffrey Roberson <jeff@freebsd.org>
All rights reserved.

Copyright (c) 2008 Nokia Corporation
All rights reserved.

Redistribution and use in source and binary forms, with or without modification, are permitted provided that the following conditions are met:

1. Redistributions of source code must retain the above copyright notice unmodified, this list of conditions, and the following disclaimer.
2. Redistributions in binary form must reproduce the above copyright notice, this list of conditions and the following disclaimer in the documentation and/or other materials provided with the distribution.

THIS SOFTWARE IS PROVIDED BY THE AUTHOR ``AS IS" AND ANY EXPRESS OR IMPLIED WARRANTIES, INCLUDING, BUT NOT LIMITED TO, THE IMPLIED WARRANTIES OF MERCHANTABILITY AND FITNESS FOR A PARTICULAR PURPOSE ARE DISCLAIMED. IN NO EVENT SHALL THE AUTHOR BE LIABLE FOR ANY DIRECT, INDIRECT, INCIDENTAL, SPECIAL, EXEMPLARY, OR CONSEQUENTIAL DAMAGES (INCLUDING, BUT NOT LIMITED TO, PROCUREMENT OF SUBSTITUTE GOODS OR SERVICES; LOSS OF USE, DATA, OR PROFITS; OR BUSINESS INTERRUPTION) HOWEVER CAUSED AND ON ANY THEORY OF LIABILITY, WHETHER IN CONTRACT, STRICT LIABILITY, OR TORT (INCLUDING NEGLIGENCE OR OTHERWISE) ARISING IN ANY WAY OUT OF THE USE OF THIS SOFTWARE, EVEN IF ADVISED OF THE POSSIBILITY OF SUCH DAMAGE.

\$FreeBSD: head/sys/sys/_bitset.h 299184 2016-05-06 16:41:23Z royger \$

(56)

Copyright (c) 1982, 1986, 1990, 1993, 1994

The Regents of the University of California. All rights reserved.

(c) UNIX System Laboratories, Inc.

All or some portions of this file are derived from material licensed to the University of California by American Telephone and Telegraph Co. or Unix System Laboratories, Inc. and are reproduced herein with the permission of UNIX System Laboratories, Inc.

Redistribution and use in source and binary forms, with or without modification, are permitted provided that the following conditions are met:

1. Redistributions of source code must retain the above copyright notice, this list of conditions and the following disclaimer.
2. Redistributions in binary form must reproduce the above copyright notice, this list of conditions and the following disclaimer in the documentation and/or other materials provided with the distribution.
3. Neither the name of the University nor the names of its contributors may be used to endorse or promote products derived from this software without specific prior written permission.

THIS SOFTWARE IS PROVIDED BY THE REGENTS AND CONTRIBUTORS ``AS IS" AND ANY EXPRESS OR IMPLIED WARRANTIES, INCLUDING, BUT NOT LIMITED TO, THE IMPLIED WARRANTIES OF MERCHANTABILITY AND FITNESS FOR A PARTICULAR PURPOSE ARE DISCLAIMED. IN NO EVENT SHALL THE REGENTS OR CONTRIBUTORS BE LIABLE FOR ANY DIRECT, INDIRECT, INCIDENTAL, SPECIAL, EXEMPLARY, OR CONSEQUENTIAL DAMAGES (INCLUDING, BUT NOT LIMITED TO, PROCUREMENT OF SUBSTITUTE GOODS OR SERVICES; LOSS OF USE, DATA, OR PROFITS; OR BUSINESS INTERRUPTION) HOWEVER CAUSED AND ON ANY THEORY OF LIABILITY, WHETHER IN CONTRACT, STRICT LIABILITY, OR TORT (INCLUDING NEGLIGENCE OR OTHERWISE) ARISING IN ANY WAY OUT OF THE USE OF THIS SOFTWARE, EVEN IF ADVISED OF THE POSSIBILITY OF SUCH DAMAGE.

@(#)filio.h 8.1 (Berkeley) 3/28/94

\$FreeBSD: head/sys/sys/filio.h 314436 2017-02-28 23:42:47Z imp \$

(57)

Configuration for math routines.

Copyright (c) 2017 ARM Ltd. All rights reserved.

Redistribution and use in source and binary forms, with or without modification, are permitted provided that the following conditions are met:

1. Redistributions of source code must retain the above copyright notice, this list of conditions and the following disclaimer.
2. Redistributions in binary form must reproduce the above copyright notice, this list of conditions and the following disclaimer in the documentation and/or other materials provided with the distribution.
3. The name of the company may not be used to endorse or promote products derived from this software without specific prior written permission.

THIS SOFTWARE IS PROVIDED BY ARM LTD ``AS IS AND ANY EXPRESS OR IMPLIED WARRANTIES, INCLUDING, BUT NOT LIMITED TO, THE IMPLIED WARRANTIES OF MERCHANTABILITY AND FITNESS FOR A PARTICULAR PURPOSE ARE DISCLAIMED. IN NO EVENT SHALL ARM LTD BE LIABLE FOR ANY DIRECT, INDIRECT, INCIDENTAL, SPECIAL, EXEMPLARY, OR CONSEQUENTIAL DAMAGES (INCLUDING, BUT NOT LIMITED TO, PROCUREMENT OF SUBSTITUTE GOODS OR SERVICES; LOSS OF USE, DATA, OR PROFITS; OR BUSINESS INTERRUPTION) HOWEVER CAUSED AND ON ANY THEORY OF LIABILITY, WHETHER IN CONTRACT, STRICT LIABILITY, OR TORT (INCLUDING NEGLIGENCE OR OTHERWISE) ARISING IN ANY WAY OUT OF THE USE OF THIS SOFTWARE, EVEN IF ADVISED OF THE POSSIBILITY OF SUCH DAMAGE.

(58)

Copyright (c) 2007 The NetBSD Foundation, Inc.

All rights reserved.

This code is derived from software written by Stephen L. Moshier.

It is redistributed by the NetBSD Foundation by permission of the author.

Redistribution and use in source and binary forms, with or without modification, are permitted provided that the following conditions are met:

1. Redistributions of source code must retain the above copyright notice, this list of conditions and the following disclaimer.
2. Redistributions in binary form must reproduce the above copyright notice, this list of conditions and the following disclaimer in the documentation and/or other materials provided with the distribution.

THIS SOFTWARE IS PROVIDED BY THE NETBSD FOUNDATION, INC. AND CONTRIBUTORS ``AS IS" AND ANY EXPRESS OR IMPLIED WARRANTIES, INCLUDING, BUT NOT LIMITED TO, THE IMPLIED WARRANTIES OF MERCHANTABILITY AND FITNESS FOR A PARTICULAR PURPOSE ARE DISCLAIMED. IN NO EVENT SHALL THE FOUNDATION OR CONTRIBUTORS BE LIABLE FOR ANY DIRECT, INDIRECT, INCIDENTAL, SPECIAL, EXEMPLARY, OR CONSEQUENTIAL DAMAGES (INCLUDING, BUT NOT LIMITED TO, PROCUREMENT OF SUBSTITUTE GOODS OR SERVICES; LOSS OF USE, DATA, OR PROFITS; OR BUSINESS INTERRUPTION) HOWEVER CAUSED AND ON ANY THEORY OF LIABILITY, WHETHER IN CONTRACT, STRICT LIABILITY, OR TORT (INCLUDING NEGLIGENCE OR OTHERWISE) ARISING IN ANY WAY OUT OF THE USE OF THIS SOFTWARE, EVEN IF ADVISED OF THE POSSIBILITY OF SUCH DAMAGE.

(59)

(c) Copyright 2017 Michael R. Neilly
All rights reserved.

Redistribution and use in source and binary forms, with or without modification, are permitted provided that the following conditions are met:

- * Redistributions of source code must retain the above copyright notice, this list of conditions and the following disclaimer.
- * Redistributions in binary form must reproduce the above copyright notice, this list of conditions and the following disclaimer in the documentation and/or other materials provided with the distribution.
- * Neither the names of the copyright holders nor the names of their contributors may be used to endorse or promote products derived from this software without specific prior written permission.

THIS SOFTWARE IS PROVIDED BY THE COPYRIGHT HOLDERS AND CONTRIBUTORS "AS IS" AND ANY EXPRESS OR IMPLIED WARRANTIES, INCLUDING, BUT NOT LIMITED TO, THE IMPLIED WARRANTIES OF MERCHANTABILITY AND FITNESS FOR A PARTICULAR PURPOSE ARE DISCLAIMED. IN NO EVENT SHALL THE COPYRIGHT OWNER OR CONTRIBUTORS BE LIABLE FOR ANY DIRECT, INDIRECT, INCIDENTAL, SPECIAL, EXEMPLARY, OR CONSEQUENTIAL DAMAGES (INCLUDING, BUT NOT LIMITED TO, PROCUREMENT OF SUBSTITUTE GOODS OR SERVICES; LOSS OF USE, DATA, OR PROFITS; OR BUSINESS INTERRUPTION) HOWEVER CAUSED AND ON ANY THEORY OF LIABILITY, WHETHER IN CONTRACT, STRICT LIABILITY, OR TORT (INCLUDING NEGLIGENCE OR OTHERWISE) ARISING IN ANY WAY OUT OF THE USE OF THIS SOFTWARE, EVEN IF ADVISED OF THE POSSIBILITY OF SUCH DAMAGE.

• **libgloss**

(1) Red Hat Incorporated

Copyright (c) 1994-2009 Red Hat, Inc. All rights reserved.

This copyrighted material is made available to anyone wishing to use, modify, copy, or redistribute it subject to the terms and conditions of the BSD License. This program is distributed in the hope that it will be useful, but WITHOUT ANY WARRANTY expressed or implied, including the implied warranties of MERCHANTABILITY or FITNESS FOR A PARTICULAR PURPOSE. copy of this license is available at <http://www.opensource.org/licenses>. Any Red Hat trademarks that are incorporated in the source code or documentation are not subject to the BSD License and may only be used or replicated with the express permission of Red Hat, Inc.

(2) University of California, Berkeley

Copyright (c) 1981-2000 The Regents of the University of California.
All rights reserved.

Redistribution and use in source and binary forms, with or without modification, are permitted provided that the following conditions are met:

- * Redistributions of source code must retain the above copyright notice, this list of conditions and the following disclaimer.
- * Redistributions in binary form must reproduce the above copyright notice, this list of conditions and the following disclaimer in the documentation and/or other materials provided with the distribution.

* Neither the name of the University nor the names of its contributors may be used to endorse or promote products derived from this software without specific prior written permission.

THIS SOFTWARE IS PROVIDED BY THE COPYRIGHT HOLDERS AND CONTRIBUTORS "AS IS" AND ANY EXPRESS OR IMPLIED WARRANTIES, INCLUDING, BUT NOT LIMITED TO, THE IMPLIED WARRANTIES OF MERCHANTABILITY AND FITNESS FOR A PARTICULAR PURPOSE ARE DISCLAIMED. IN NO EVENT SHALL THE COPYRIGHT OWNER OR CONTRIBUTORS BE LIABLE FOR ANY DIRECT, INDIRECT, INCIDENTAL, SPECIAL, EXEMPLARY, OR CONSEQUENTIAL DAMAGES (INCLUDING, BUT NOT LIMITED TO, PROCUREMENT OF SUBSTITUTE GOODS OR SERVICES; LOSS OF USE, DATA, OR PROFITS; OR BUSINESS INTERRUPTION) HOWEVER CAUSED AND ON ANY THEORY OF LIABILITY, WHETHER IN CONTRACT, STRICT LIABILITY, OR TORT (INCLUDING NEGLIGENCE OR OTHERWISE) ARISING IN ANY WAY OUT OF THE USE OF THIS SOFTWARE, EVEN IF ADVISED OF THE POSSIBILITY OF SUCH DAMAGE.

(3) DJ Delorie

Copyright (C) 1993 DJ Delorie
All rights reserved.

Redistribution, modification, and use in source and binary forms is permitted provided that the above copyright notice and following paragraph are duplicated in all such forms.

This file is distributed WITHOUT ANY WARRANTY; without even the implied warranty of MERCHANTABILITY or FITNESS FOR A PARTICULAR PURPOSE.

(5) Advanced Micro Devices

Copyright 1989, 1990 Advanced Micro Devices, Inc.

This software is the property of Advanced Micro Devices, Inc (AMD) which specifically grants the user the right to modify, use and distribute this software provided this notice is not removed or altered. All other rights are reserved by AMD.

AMD MAKES NO WARRANTY OF ANY KIND, EXPRESS OR IMPLIED, WITH REGARD TO THIS SOFTWARE. IN NO EVENT SHALL AMD BE LIABLE FOR INCIDENTAL OR CONSEQUENTIAL DAMAGES IN CONNECTION WITH OR ARISING FROM THE FURNISHING, PERFORMANCE, OR USE OF THIS SOFTWARE.

So that all may benefit from your experience, please report any problems or suggestions about this software to the 29K Technical Support Center at 800-29-29-AMD (800-292-9263) in the USA, or 0800-89-1131 in the UK, or 0031-11-1129 in Japan, toll free. The direct dial number is 512-462-4118.

Advanced Micro Devices, Inc.
29K Support Products
Mail Stop 573
5900 E. Ben White Blvd.
Austin, TX 78741
800-292-9263

(8) Sun Microsystems

Copyright (C) 1993 by Sun Microsystems, Inc. All rights reserved.

Developed at SunPro, a Sun Microsystems, Inc. business. Permission to use, copy, modify, and distribute this software is freely granted, provided that this notice is preserved.

(9) Hewlett Packard

(c) Copyright 1986 HEWLETT-PACKARD COMPANY

To anyone who acknowledges that this file is provided "AS IS" without any express or implied warranty: permission to use, copy, modify, and distribute this file for any purpose is hereby granted without fee, provided that the above copyright notice and this notice appears in all copies, and that the name of Hewlett-Packard Company not be used in advertising or publicity pertaining to distribution of the software without specific, written prior permission. Hewlett-Packard Company makes no representations about the suitability of this software for any purpose.

(10) Hans-Peter Nilsson

Copyright (C) 2001 Hans-Peter Nilsson

Permission to use, copy, modify, and distribute this software is freely granted, provided that the above copyright notice, this notice and the following disclaimer are preserved with no changes.

THIS SOFTWARE IS PROVIDED "AS IS" AND WITHOUT ANY EXPRESS OR IMPLIED WARRANTIES, INCLUDING, WITHOUT LIMITATION, THE IMPLIED WARRANTIES OF MERCHANTABILITY AND FITNESS FOR A PARTICULAR PURPOSE.

(14) - National Semiconductor Corporation

Copyright (c) 2004 National Semiconductor Corporation

The authors hereby grant permission to use, copy, modify, distribute, and license this software and its documentation for any purpose, provided that existing copyright notices are retained in all copies and that this notice is included verbatim in any distributions. No written agreement, license, or royalty fee is required for any of the authorized uses. Modifications to this software may be copyrighted by their authors and need not follow the licensing terms described here, provided that the new terms are clearly indicated on the first page of each file where they apply.

**SPECIFICATIONS OF AUTOPILOT
NAVpilot-1000**

1 CONTROL UNIT

- 1.1 Display 5.7-inch color LCD, 640 x 480 (VGA)
- 1.2 Brilliance 720 cd/m²
- 1.3 Picture color 262,144 colors (6 bits/RGB)
- 1.4 Visible distance 0.62 m nominal
- 1.5 Max. number of units in a network
6 units (requires external 9-16 V power source and isolator for connection of 4 or more units)
- 1.6 Language English (US/UK)

2 PROCESSOR UNIT

- 2.1 Steering mode STBY, AUTO, Advanced AUTO, NAV*¹ (Standard/Precision), FU-RC*², NFU-RC*¹ *², FU-KEY*², NFU-KEY*², DISENGAGED (FU/NFU: Follow-Up/Non-Follow-Up, RC/KEY: remote/keyboard control)
*¹: Non-IMO type only, *²: Available only when the RRU is installed.
- 2.2 Rudder gains Auto/ Manual (0.1-4.0)
- 2.3 Counter rudder Auto/ Manual (0.0-20.0)
- 2.4 Trim gain Auto/ Manual (1-30)
- 2.5 Rate of turn 0.1-10 deg/s
- 2.6 Rudder angle settings ±45 deg
- 2.7 Alert Heading monitor, Watch, Off heading
- 2.8 Rudder control (analog)
Voltage 0 to 5 V (min), -10 to +10 V (max.) (5 mA max.)
Current 4 to 20 mA (load resistance 500 ohm max.)
- 2.9 Solenoid control for rudder on/off
Isolation Galvanic/non-galvanic isolation
Connection Common negative
Load range 3 A max.
- 2.10 Clutch/ Bypass drive for rudder
Isolation Galvanic/non-galvanic isolation
Connection Common negative
Load range 3 A max.

3 INTERFACE

- 3.1 Number of port
 - Serial 4 ports, I/O, IEC61162-1 Ed.3 to 5, NMEA0183 Ver1.5/2.0, 4800/38400 bps
 - LAN 1 port, Ethernet 100Base-TX, IEEE802.3 data link, IGMPv2 acceptable
 - NMEA2000 1 port, for control unit
 - Universal output 6 ports (dry contact), alarm/status: 100 mA max.

	Universal input	4 ports (dry contact)
	Power failure	1 ports, 12-24V:100mA max.
	Changeover switch	1 port (input)
	USB	1 port, usb2.0, for maintenance
3.2	Data sentences	IEC61162-1/2 (NMEA0183), IEC61162-450
	Input	AAM, ACN (ACM), APB, BOD, BWC, BWR, GGA, GLL, GNS, HBT, HCR, HDG, HDM, HDT, MWV, RMB, RMC, ROT, THS, VBW, VHW, VTG, VWR, VWT, XTE, ZDA
	Output	ALC, ALF, ALR, ARC, EVE, GGA*, GLL*, GNS*, HBT, HDG*, HDM*, HDT*, HTD, RMB*, RMC*, ROT*, RSA, THS*, VBW*, VHW*, VTG*, ZDA*
		*: for Non-IMO type
3.3	NMEA2000 PGNs	
	Input	059392/904, 060160/416/928, 061184, 065240/283/284, 126208/464/720/992/996, 127250/258, 128259 129025/026/029/033/283/284/285/538, 130306/577/816/818/827/841
	Output	059392/904, 060928, 061184, 126208/464/720/993/996/998, 127245/237, 130816/822/823/827/841
3.4	IEC61162-450 transmission group	
	Input	MISC, SATD, NAVD, TIME, PROP, CAM1, CAM2, NETA
	Output	Arbitrary (default: NAVD), BAM1, NETA
3.5	Network functions (except IEC61162-450)	
	Data format	SSDP, HTTP, Syslog
4	POWER SUPPLY	
4.1	Processor unit	12-24 VDC (10.8-31.2 V): 4.0-2.0 A (control unit: 3 units), LEN: 2 Network power supply \leq LEN: 42
4.2	Control unit	15 VDC, LEN: 14
5	ENVIRONMENTAL CONDITIONS	
5.1	Ambient temperature	-15°C to +55°C
5.2	Relative humidity	93% or less at +40°C
5.3	Degree of protection	
	Processor/control unit	IP22
5.4	Vibration	IEC 60945 Ed.4
6	UNIT COLOR	
6.1	Processor unit	N2.5
6.2	Control unit	N1.0

INDEX

A

- Advanced AUTO mode 2-2, 2-5
- Alert box 1-5, 3-2
- Alert list 3-4
- Alert log 3-5
- Alert state icon 3-2
- Alerts
 - acknowledging 3-4
 - alert list 3-4
 - alert state icons 3-2
 - definition 3-1
- AUTO mode 2-1, 2-4

B

- Brilliance adjustment 1-3
- Buzzer volume 4-1

C

- Control description 1-1
- Counter rudder setting 1-8

D

- Data box 1-5
- Diagnostics
 - Control unit test 5-5
 - Keyboard test 5-6
 - Processor unit test 5-4
 - Screen test 5-7
- DISENGAGED mode 2-2
- Display color
 - black background 1-3
 - white background 1-3
- Display format 4-2
- Display mode icon 1-5

F

- FU (Follow Up) mode 2-2, 2-12
- Fuse replacement 5-3

H

- Header 1-4, 1-5
- Heading indication 1-4
- Heading monitor alert 1-12

I

- INACTIVE mode 2-2
- Installation Menu 4-3

K

- Key beep 4-1
- Key brightness 1-3
- Key lock 4-2
- Key lock icon 1-5

M

- Maintenance 5-1
- Menu tree AP-1

N

- NAV mode 2-2
 - description 2-7
 - sailing method for 2-8
 - waypoint switching method 2-9
- NFU (Non-Follow Up) mode 2-12

O

- Off heading alert 1-13

P

- Power key 1-2

R

- Radius of turn 1-9
- Rate of turn 1-9
- RC FU mode 2-2, 2-13
- RC NFU mode 2-2, 2-14
- Remote maintenance icon 1-5
- Rudder gain 1-7
- Rudder indicator 1-4
- Rudder Sensitivity 1-9

S

- Screen brightness 1-3
- Self-learning feature 1-9
- Simulation mode icon 1-5
- Startup error message 1-2
- Startup test 1-2
- STBY mode 2-1, 2-4
- Steering mode data 1-4
- Steering mode indication 1-4
- System configuration ix

T

- Trim Gain 1-9
- Trim response 1-9
- TURN mode
 - turn angle setting 2-11
 - turn selection 2-10

U

- UNKNOWN mode 2-2

W

- Watch alert 1-13
- Weather Deadband setting 1-7
- Work profile
 - activate 1-8, 1-10
 - create 1-8
 - deactivate 1-8, 1-10
 - edit 1-8
 - restore factory default settings 1-10, 1-11
 - select 1-10
- Work profile indication 1-4
- Working indicator 1-6



0575

Declaration of Conformity



0097

We FURUNO ELECTRIC CO., LTD.

(Manufacturer)

9-52 Ashihara-Cho, Nishinomiya City, 662-8580, Hyogo, Japan

(Address)

declare under our sole responsibility that the product

AUTOPILOT NAVpilot-1000
(Serial No. 1001-60xx/90xx-xxxx)

(Model name, type number)

to which this declaration relates conforms to the following standard(s) or other normative document(s)

EU

Directive 2014/90/EU on Marine Equipment
(MED) as amended the Implementing Regulation
(EU) 2024/1975

SOLAS 74 Reg. V/18, V/19 & X/3
IMO Res. A.342(IX), A.694(17), A.822(19),
MSC.36(63), MSC.64(67) Annex 3,
MSC.97(73), MSC.191(79), MSC.302(87),
IMO MSC.1/Circ.1349

UK

UK MCA Merchant Shipping (Marine Equipment)
Regulations 2016 (MER) as amended MSN 1874
Amendment 9

SOLAS 74 Reg. V/18, V/19 & X/3
IMO Res. A.342(IX), A.694(17), A.822(19),
MSC.36(63), MSC.64(67) Annex 3,
MSC.97(73), MSC.191(79), MSC.302(87),
IMO MSC.1/Circ.1349

(title and number of the requirements)

For assessment, see

- EC-type examination certificate (Module B)
MEDB00007SD Rev.1: DNV AS (0575)
- Product Quality System certificate (Module D)
MEDD00002CD Rev.6: DNV AS (0575)

For assessment, see

- UK-type examination certificate (Module B)
MERB00007SD Rev.0: DNV UK Ltd. (0097)
- Product Quality System certificate (Module D)
MERD00002CD Rev.4: DNV UK Ltd. (0097)

On behalf of Furuno Electric Co., Ltd.

Nishinomiya City, Japan
4 September 2024

(Place and date of issue)

Akihiko Kanechika
Department General Manager
Quality Assurance Department

(name and signature or equivalent marking of authorized person)